



**MIRION**  
TECHNOLOGIES



# Instrumentation & Control





**MIRION**  
TECHNOLOGIES

## PROTECT WHAT'S NEXT



At Mirion Technologies, we partner with industry leaders to advance radiation safety and empower the next wave of critical innovation. From R&D labs, to critical nuclear facilities, and on the front lines, we provide proven radiation safety technologies that operate at the highest levels of precision, and deliver trusted expertise that empowers our customers to solve problems and enable breakthrough innovation.

### **Our Mission:**

**To harness our unrivaled knowledge of ionizing radiation for the greater good of humanity.**

# INSTRUMENTATION & CONTROL

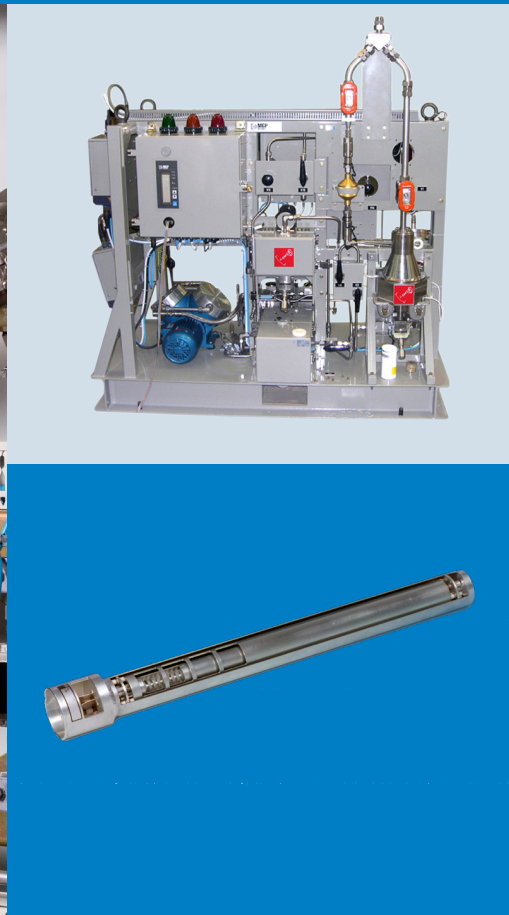

Our ultra-precise instruments help nuclear operators maintain reactor safety and peak operational performance.

- ✓ Radiation Monitoring Systems
- ✓ In-Core & Ex-Core Detectors
- ✓ Electrical Penetrations
- ✓ Nuclear Containment Seals



# TABLE OF CONTENTS

## RADIATION MONITORING SYSTEMS

### Control and Reactor Protection

#### **Boron Meters**

- BM 501

#### **Steam Generator Leak Rate Monitors**

- SGLM 201K
- SGLM 202K
- SGLM 510

#### **Spectrum Analysis Monitors**

- SAM 201K
- SAM 202K
- SAM 203K
- SAM 204K

### Area Monitoring / Radioprotection

#### **Gamma Dose Rate Measurement**

- GIM 201K
- G64
- GIM 204K
- GIM 205K

#### **Severe Accident (LOCA) Channels**

- GIM 202K
- GIM 203K
- GIM 206K

#### **Irradiation Monitors**

- BIM 201K
- NIM 201K

#### **Detectors**

- KB 100 PEF/SEF
- KG Series
- KG 50/51 SEC
- KG 80 PED/PEF
- KG 151 RBT/REZ
- KG 220 SEF

## Effluent Release Monitoring

### Alpha and Beta Particles Monitors

- ABPM 201S
- ABPM 203M
- ABPM 204M
- ABPM 205L
- ABPM 205M
- PM 205S
- iCAM
- iCAM RH
- BAC
- BAS

### Iodine Monitors

- IM 201L
- IM 201M
- IM 201S
- IM 203M

### Noble Gas Monitors

- NGM 202L
- NGM 203S
- NGM 204L
- NGM 204S
- NGM 209M
- NGM 216S

### Combined Stack Monitors

- PING 206S
- PIM 206S
- PNG 206S
- PINGM 207S

### Liquid Monitors

- LM 211S
- LM 212S

### Particles and Iodine Samplers

- PIS 203S
- PIS 204L
- PIS 205L

## Signal Processing Units

- LP(D)U
- ADU
- RDU

## Software

- MASS2
- RAMVISION
- SIMS

## Accessories

- TKA
- Particulate Paper Filter
- iCAM Fixed Filters

## TRITIUM MONITORING

### Monitors Range

#### Samplers

- HT ionix
- HC ionix

#### Portable Monitors

- $\beta$  ionix

#### Installed Tritium Monitors

- C ionix - BXX
- C ionix - HTO
- SAM HTO
- C ionix - GN
- C ionix - EXX
- M ionix
- DT ionix

#### Detectors

- DT D - MC10
- DT D - MLB
- DT D - BL2
- DT D - IC500
- DT D - BM8
- DT D - BM8 - HE
- DT D - EXP40
- DT D - XPR80

## NEUTRON FLUX MONITORING SYSTEMS

### proTK

- proTK for Research Reactors

### Neutron Flux Monitors

- SRM 510
- IRM 510
- PRM 510
- WRM 510

### Signal Channels

- DAK 260
- DGK 260
- DWK 260

### Detectors

- KNK/KNU 50 ACH
- PN 25/PN 50

## SENSING SYSTEMS

### Electrical Penetration Assemblies

- EPA

### Severe Accident Connectors

- Fiber Optic
- ECSA
- NSC
- Nuclear Service Temperature Sensor
- Special Purpose Valve

### Thermocouple

- Thermowell

## SERVICES

- Basic Agreement
- Maintenance
- Software Maintenance
- Hotline & Support
- Taking Back of Sources
- Training
- Warranty Extension





PROTK™

# BM 501™

## Boron Meter



Continuously measuring the boron concentration in water circulating in process of light water nuclear power plants.

### DESCRIPTION

The BM 501 boron meter forms part of the proTK™ product line. The BM 501 meter is designed to continuously measure the boron concentration in water circulating in process of light water nuclear power plants. The measurement principle is based on measuring the neutron absorption rate through the B-10 isotope, which depends on the boron concentration contained in the water coolant.

The neutrons are generated by an internal source, which is part of the detection sub-assembly.

### FEATURES

- ✓ Non-intrusive on-line measurement, directly placed around process pipe
- ✓ Can be adapted to pipe diameter
- ✓ Category B software according to IEC 62138
- ✓ Seismic qualification
- ✓ Temperature compensated measurement
- ✓ Detection sub-assembly featuring a moderator/shield (for neutron thermalization and radiation protection)
- ✓ Standard version with two detectors, temperature sensors and signal processing units for redundancy of measurement (also available with single detector)

## BM 501™ BORON METER

### PHYSICAL CHARACTERISTICS

- Detector: Boron-lined proportional counter
- Measurement capability: up to 3500 ppm (Boron total)
- Neutron source: Am-Be ( $7.4 \times 10^{10}$  Bq, can be adapted to the application)
- Dose rate on contact with the detection sub-assembly: less than 300  $\mu$ Sv/h

### ENVIRONMENTAL CHARACTERISTICS

- Average long-term temperature ranges:
  - For detection sub-assembly, pipe shall not exceed: +10 °C to +60 °C (+50 °F to +140 °F)
  - Preamplifier: 0 °C to +55 °C (+32 °F to +131 °F)
  - Processing unit: +10 °C to +40 °C (+50 °F to +104 °F)
- Short-term maximum temperature ranges:
  - For detection sub-assembly, pipe shall not exceed: +110 °C (+230 °F) for 1.5 hours, followed by cooling at +5 °C/h
  - Processing unit: 0 °C to +45 °C (+32 °F to 113 °F)
- TID (detection sub-assembly and pre-amplifier): 8.7 kGy (0.87 Mrad)
- Protection index (detection sub-assembly): IP25 and IK07
- MTBF (preamplifier and processing unit): > 180 000 hours

### MECHANICAL CHARACTERISTICS

- Approximate dimensions:
  - Detection sub-assembly (L x H x D): 553 mm x 390 mm x 334 mm (21.8 in x 15.4 in x 13.2 in)
  - Processing unit: standard 19" x 3U rack
- Typical pipe: DN 80, DN 100 (may differ according to process design and operating conditions)

### ELECTRICAL CHARACTERISTICS

- Power supply: 230 Vac (187 to 242 Vac)
- Two isolated analog outputs (4-20 mA) for:
  - Total Boron concentration
  - B10 concentration
- Two SPDT alarm relays for:
  - Boron meter fault
  - Boron concentration  $\leq$  alarm threshold
- Local RS232/RS485 on the front panel of the processing unit
- Distance between processing unit and preamplifier (mounted next to the detection sub-assembly): 200 m max. (656 ft)

### SIGNALING (ON PROCESSING UNIT)

- Alphanumeric display (2 lines x 16 characters) for measurement and status indication
- Status LEDs on the front panel

### REFERENCE STANDARDS

- Software: class C2 according to RCC-E C5130, for functions category B according to IEC 62138
- Qualification: K3 according to RCC-E-B4000
- Seismic: IEC 60980, IEC 60068-3-3
- EMC/RF: IEC 61000-6-2 and IEC 61000-6-4
- European directives: 2014/30/EU and 2014/35/EU

### VERSIONS

- 230/115 Vac or 24 Vdc
- One or two detectors and processing units
- Detection sub-assembly for DN 80 or DN 100 pipes
- Various detector cable lengths
- Additional analog or binary I/O modules
- Off-line version (design upon request)

### ACCESSORIES

- Calibration software



**MIRION**  
TECHNOLOGIES

Copyright © 2023 Mirion Technologies, Inc. or its affiliates. All rights reserved. Mirion, the Mirion logo, and other trade names of Mirion products listed herein are registered trademarks or trademarks of Mirion Technologies, Inc. or its affiliates in the United States and other countries. Third party trademarks mentioned are the property of their respective owners.



RAMSYS™

# SGLM 201K™

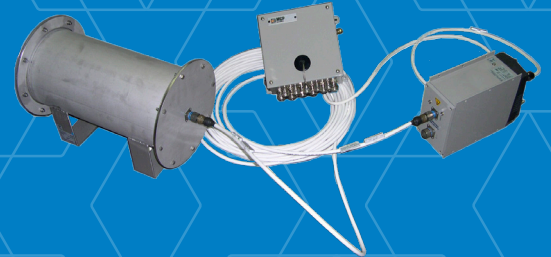

## Steam Generator Leak Rate Monitor

Monitoring steam generator leak rate in PWR nuclear power plants by measuring  $^{16}\text{N}$  activity

### DESCRIPTION

The SGLM 201K monitor forms part of the RAMSYS product line. It has been designed to detect and quantify leaks between the primary and the secondary circuits of a steam generator in a nuclear power plant. It operates on the principle that radioactive nitrogen ( $^{16}\text{N}$ ) produced in the reactor core during operation crosses into the secondary circuit through a steam generator tube crack (or hole). The  $^{16}\text{N}$  is carried away by the steam and is detected in the main steam line (MSL) outside containment.

For the SGLM 201K version: the NaI(Tl) detector is wrapped with thick thermal insulation to prevent damage that may be caused by high temperature gradients.

### FEATURES

- ✓  $^{16}\text{N}$  monitoring when reactor power exceeds 25%
- ✓ Gross gamma energy monitoring when reactor power < 25%
- ✓ Spectrum stabilization against temperature and aging drifts
- ✓ 16 selectable windows over the range covered
- ✓ 1024-channel analysis
- ✓ Available with or without display and local signaling
- ✓ Seismically qualified
- ✓ More than 800 SGLM channels in operation worldwide
- ✓ Designed for 1E mild environment conditions

# SGLM 201K™ STEAM GENERATOR LEAK RATE MONITOR

## PHYSICAL CHARACTERISTICS

- Radiation detected: gamma
- Detector: 3"x2" NaI(Tl) scintillator + PMT (SG/NAI 61)
- Energy range:
  - <sup>16</sup>N window: 4.5 MeV to 7 MeV
  - Gamma window: 0.2 MeV to 2.2 MeV
- Measurement range:
  - Leak rate: 0.1 to 5 000 l/h (0.64 to 31 700 GPD)
  - Gamma: 0.5 to 100 000 cps
- Spectrum analysis: 1024 channels

## ENVIRONMENTAL CHARACTERISTICS

- Normal temperature: +5 °C to +40 °C (+41 °F to +104 °F)
- Temperature limit: -5 °C to +55 °C (+23 °F to +131 °F)
- Detector temperature transient (accident condition):
  - 150 °C (302 °F) - 5 min
  - 100 °C (212 °F) - 10 min
  - Back to 55 °C (131 °F) in 1 hour
  - Temperature gradient: 600 °C/h (1112 °F/h)
- MTBF (LPDU): > 50 000 hours
- TID: 100 Gy (10<sup>+4</sup> rad)
- Protection index: IP65 and IK07

## MECHANICAL CHARACTERISTICS

- Dimensions:
  - Processing unit: 390 mm x 196 mm x 187 mm (15.3 in x 7.7 in x 7.3 in)
  - Detector: 305 mm x 270 mm x 452 mm (12 in x 10.6 in x 17.8 in)
- Weight:
  - Processing unit: 8 kg (17.6 lb)
  - Detector: 17 kg (37.5 lb)
- Color: gray RAL 7030 (decontaminable paint)

## ELECTRICAL CHARACTERISTICS

- Power supply: 230 Vac – 50 Hz or 120 Vac – 60 Hz
- Data link outputs: one RS232 (LPDU only) and two isolated RS485
- Alarm relays: three SPDT relays
- I/O: two isolated analog outputs and one isolated analog input (0/4-20 mA)

## SIGNALING (APPLICABLE TO LPDU ONLY)

- Alphanumeric display: measurement, status...
- Sound alarm: buzzer 90 dBA at 1 meter
- Visual alarm: three lights (red, yellow, green)

## REFERENCE STANDARDS

- Environmental: IEC/IEEE 60780-323
- Seismic: IEEE 344 and IEC 60980
- EMC: 2014/30/EU and 2014/35/EU, EPRI 102323, RG 1.180, IEC 61000-6-2 and IEC 61000-6-4

## VERSIONS

- 230 Vac or 120 Vac
- Local processing and display unit (LPDU) or local processing unit (LPU)
- With or without RS485 junction box
- Detector cable length: from 20 m (65.6 ft) to 100 m (328 ft)
- Junction box cable length: 2 m (6.56 ft), 5 m (16.4 ft) or 10 m (32.8 ft)

## ACCESSORIES

- Calibration tools
- Software: MASS2™, RAMVISION™, SIMS2™ applications...
- Ethernet (LPDU version only)
- USB converters
- Seismic qualified wall mounting bracket for LP(D)U
- Seismic qualified detector support

## NOTE

The <sup>16</sup>N monitor can measure the <sup>16</sup>N count rate in the MSL with a relatively high precision and can convert the count rate into leak rate if the power nuclear level is provided by the manufacturer by means of an 0/4-20 mA current loop.

Converting the count rate to volumetric activity requires detailed Monte Carlo analysis. Mirion Technologies can provide such analysis.

Correlating leak rate (in units of l/h or GPD) to <sup>16</sup>N activity requires a detailed thermo hydraulic analysis and knowledge pertaining to the leak location.

The steam generator manufacturer typically provides the thermo-hydraulic data required for establishing leak rate correlations.

Mirion Technologies can provide the overall analysis for establishing the leak rate correlations if the thermo-hydraulic data is available.



**MIRION**  
TECHNOLOGIES

Copyright © 2024 Mirion Technologies, Inc. or its affiliates. All rights reserved. Mirion, the Mirion logo, and other trade names of Mirion products listed herein are registered trademarks or trademarks of Mirion Technologies, Inc. or its affiliates in the United States and other countries. Third party trademarks mentioned are the property of their respective owners.



RAMSYS™

# SGLM 202K™

## Steam Generator Leak Rate Monitor



Monitoring steam generator leak rate in WWER nuclear power plants by measuring  $^{16}\text{N}$  activity

### DESCRIPTION

The SGLM 202K monitor forms part of the RAMSYS product line. It has been designed to detect and quantify leaks between the primary and the secondary circuits of a steam generator in a nuclear power plant. It operates on the principle that radioactive nitrogen ( $^{16}\text{N}$ ) produced in the reactor core during operation crosses into the secondary circuit through a steam generator tube crack (or hole). The  $^{16}\text{N}$  is carried away by the steam and is detected in the main steam line (MSL) outside containment.

For the SGLM 202K version: the NaI(Tl) detector is enclosed inside a  $2 \pi / 5 \text{ cm}$  (2") thick lead shielding to ensure protection against the ambient gamma background noise. This detector has no thermal insulation.

### FEATURES

- ✓  $^{16}\text{N}$  monitoring when reactor power exceeds 25%
- ✓ Gross gamma energy monitoring when reactor power < 25%
- ✓ Spectrum stabilization against temperature and aging drifts
- ✓ 16 selectable windows over the range covered
- ✓ 1024-channel analysis
- ✓ Available with or without display and local signaling
- ✓ Seismically qualified
- ✓ More than 800 SGLM channels in operation worldwide
- ✓ Designed for 1E mild environment conditions

# SGLM 202K™ STEAM GENERATOR LEAK RATE MONITOR

## PHYSICAL CHARACTERISTICS

- Radiation detected: gamma
- Detector: 3"x2" NaI(Tl) scintillator + PMT (SG/NAI 111)
- Energy range:
  - <sup>16</sup>N window: 4.5 MeV to 7 MeV
  - Gamma window: 0.2 MeV to 2.2 MeV
- Measurement range:
  - Leak rate: 0.1 to 5 000 l/h (0.64 to 31 700 GPD); Bq/m<sup>3</sup> (μCi/cc) unit also possible; based on user requirements
  - Gamma: 0.5 to 100 000 cps
- Spectrum analysis: 1024 channels
- Lead shield: 2 π / 5 cm (2 π / 2 in)

## ENVIRONMENTAL CHARACTERISTICS

- Normal temperature: +5 °C to +40 °C (+41 °F to +104 °F)
- Temperature limit: -5 °C to +55 °C (+23 °F to +131 °F)
- MTBF (LPDU): > 50 000 hours
- TID: 100 Gy (10<sup>+4</sup> rad)
- Protection index: IP65 and IK07

## MECHANICAL CHARACTERISTICS

- Dimensions:
  - Processing unit: 390 mm x 196 mm x 187 mm (15.3 in x 7.7 in x 7.3 in)
  - Detector: Ø 402 mm x 429 mm (Ø 15.8 in x 16.9 in)
- Weight:
  - Processing unit: 8 kg (17.6 lb)
  - Detector: 226 kg (498 lb)
- Color: gray RAL 7030 (decontaminable paint)

## ELECTRICAL CHARACTERISTICS

- Power supply: 230 Vac – 50 Hz or 120 Vac – 60 Hz
- Data link outputs: one RS232 (LPDU only) and two isolated RS485
- Alarm relays: three SPDT relays
- I/O: two isolated analog outputs and one isolated analog input (0/4-20 mA)

## SIGNALING (APPLICABLE TO LPDU ONLY)

- Alphanumeric display: measurement, status...
- Sound alarm: buzzer 90 dBA at 1 meter
- Visual alarm: three lights (red, yellow, green)

## REFERENCE STANDARDS

- Environmental: IEC/IEEE 60780-323
- Seismic: IEEE344 and IEC60980
- EMC: 2014/30/EU and 2014/35/EU, EPRI 102323, RG 1.180, IEC61000-6-2 and IEC61000-6-4

## VERSIONS

- 230 Vac or 120 Vac
- Local processing and display unit (LPDU) or local processing unit (LPU)
- With or without RS485 junction box
- Detector cable length: from 20 m (65.6 ft) to 100 m (328 ft)
- Junction box cable length: 2 m (6.56 ft), 5 m (16.4 ft) or 10 m (32.8 ft)

## ACCESSORIES

- Calibration tools
- Software: MASS2™, RAMVISION™, SIMS2™ applications...
- Ethernet (LPDU version only)
- USB converters
- Seismic qualified wall mounting bracket for LP(D)U
- Seismic qualified detector support

## NOTE

The <sup>16</sup>N monitor can measure the <sup>16</sup>N count rate in the MSL with a relatively high precision and can convert the count rate into leak rate if the power nuclear level is provided by the manufacturer by means of an 0/4-20 mA current loop.

Converting the count rate to volumetric activity requires detailed Monte Carlo analysis. Mirion Technologies can provide such analysis.

Correlating leak rate (in units of l/h or GPD) to <sup>16</sup>N activity requires a detailed thermo hydraulic analysis and knowledge pertaining to the leak location.

The steam generator manufacturer typically provides the thermo-hydraulic data required for establishing leak rate correlations.

Mirion Technologies can provide the overall analysis for establishing the leak rate correlations if the thermo-hydraulic data is available.



**MIRION**  
TECHNOLOGIES

Copyright © 2023 Mirion Technologies, Inc. or its affiliates. All rights reserved. Mirion, the Mirion logo, and other trade names of Mirion products listed herein are registered trademarks or trademarks of Mirion Technologies, Inc. or its affiliates in the United States and other countries. Third party trademarks mentioned are the property of their respective owners.



proTK™

# SGLM 510™

## Steam Generator Leakage Monitor



**Safety class (Cat. A) monitoring of the main steam line for leakages in a PWR nuclear power plant with a wide-range gamma ionization chamber.**

### DESCRIPTION

The SGLM 510 monitor is part of the proTK/260 series product line. It has been designed to detect leakages between the primary and the secondary circuits in a nuclear power plant. It operates on the principle that radioactive isotopes like N-16 that are only present in the primary circuit during normal operation cross the boundary into the secondary circuit due to a leak in a steam generator tube. The radioactive isotopes are transported through the main steam line and detected by measuring the increased level of gamma dose rate on the main steam line outside the containment.

The SGLM 510 monitor offers a wide measuring range and a processing unit designed for Cat. A safety functions.

### FEATURES

- ✓ Gross gamma dose rate monitoring of the main steam line (incl. N-16) for primary circuit leakages
- ✓ Wide measuring range (1E-7 to 1E+2 Gy/h)
- ✓ Local HMI for display of measurement values, monitoring performance and setting parameters (key locked)
- ✓ Up to eight types of safety relay outputs for alarm and fault signals and local alarm indication
- ✓ proTK™ signal processing units are modular in hardware and software, highly customizable
- ✓ Extensive self-supervision and integrated test functions
- ✓ Designed and qualified to fulfill Cat. A functions according to the IEC 61226 and for Class 1E functions

# SGLM 510™ STEAM GENERATOR LEAKAGE MONITOR

## MONITOR COMPONENTS

- KG 220 SEF-Gy ionization chamber
- TKK 22.30 H system cable
- NV 103.14 current-to-frequency converter
- NK 306/316 signal cable
- DAK 260-g digital signal processing unit

## PHYSICAL CHARACTERISTICS

- Detector geometry: dome shaped ionization chamber with a sensitive volume of 2.3 l
- Sensitive to gamma radiation
- Gamma energy range: 0.08 to 7 MeV
- Measurement range: 1E-7 to 1E+2 Gy/h
- Relative intrinsic error: < 30% (over full range)

## ENVIRONMENTAL CHARACTERISTICS

- Normal operating temperature:
  - Processing unit: +0 to +50 °C (+32 to +122 °F)
  - Detector: -30 to +100 °C (-22 to +212 °F)
  - Detector cable: -40 to +90 °C (-40 to +194 °F)
  - C/F converter, signal/supply/control cable: +0 to +70 °C (+32 to +158 °F)
- Extreme temperature:
  - Detector: 120 °C (248 °F) for 1 h
- TID (detector): 250 kGy
- Electrical protection:
  - Detector: IP65, IP67
  - Cables: IP65
- Mechanical protection (detector): IK06 (in operation), IK07 (not in operation)
- MTBF: > 100 000 h

## MECHANICAL CHARACTERISTICS

- Dimensions:
  - Processing unit: 19" rack acc. IEC 60297 for installation in an electronic cabinet
  - Detector: hemi-spherical detector (Ø 220 mm) mounted on a plate (Ø 280 mm) with total height of 243 mm
  - C/F converter: approx. 160 x 260 x 97 mm
- Weight:
  - Processing unit: approx. 9 kg
  - Detector: 23 kg
  - C/F converter: approx. 3 kg
- Color: RAL 7032 gray (processing unit - front panels and C/F converter)

## ELECTRICAL CHARACTERISTICS

- Power supply:
  - AC supply: 90 to 127 VAC or 185 to 255 VAC, 47 to 63 Hz
  - DC supply: 19.2 to 33 V incl. ripple
- Power consumption: approx. 30 VA

## INPUT/OUTPUT

- Local alphanumeric HMI for display of measurement values, monitoring performance and fault diagnostics, activating test functions, and setting parameters (key locked)
- Analogue outputs: 0/2 to 10 V or 0/4 to 20 mA
- Binary outputs: relay outputs with floating double-throw contacts
- Data interfaces: RS-232 or RS-485 (optional)

## REFERENCE STANDARDS

- System & Hardware: IEC 61513 (system design), IEC 60768 (instrumentation), IEC 60980, IEEE 344 (seismic), IEC/IEEE 60780-323 (equipment qualification), IEC 60068 (environmental), IEC 61010-1 (electrical safety), IEC 61000 series (EMC)
- Software: IEC 60880

## VERSIONS

- Configurations of the processing unit:
  - Number and type of analogue and binary outputs
  - Power supply (120/230 VAC or 24 VDC)
  - Optional RS-232/RS-485 data interfaces
- Detector cable: up to 200 m
- Various software configurations acc. IEC 60880

## ACCESSORIES

- PC software for parameter setting and data logging via serial interface.
- Electronic cabinet for 19" racks (seismic and EMC proof)
- Wall-mounted cabinets

## SUMMARY

The SGLM 510 monitor measures the gross gamma dose rate from the main steam line over a wide measurement range. The signal processing unit converts the detector signal and displays the resulting dose rate in Gy/h. This signal can be routed to a 0/4 to 20 mA current loop and is made available for plant safety systems.



**MIRION**  
TECHNOLOGIES

Copyright © 2024 Mirion Technologies, Inc. or its affiliates. All rights reserved. Mirion, the Mirion logo, and other trade names of Mirion products listed herein are registered trademarks or trademarks of Mirion Technologies, Inc. or its affiliates in the United States and other countries. Third party trademarks mentioned are the property of their respective owners.





RAMSYS™

# SAM 201K™

## Spectrum Analysis Monitor

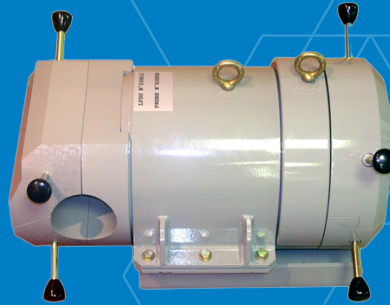

**Gamma spectra analysis with identification of isotopes. Available with a 1"x1 1/4" NaI(Tl) detector.**

### DESCRIPTION

The SAM 201K monitor forms part of the RAMSYS product line. It has been developed to detect gamma radiations and provide gamma spectra analysis with identification of isotopes.

The SAM 201K monitor is designed for continuous unattended operation and can cover most of the gamma measurement ranges required by regulations and industry guidelines. Four detector sizes are available which make this monitor very efficient and reliable, with high sensitivity, wide measurement range and fast response time.

### FEATURES

- ✓ Wide measurement range
- ✓ Can be used for various types of applications
- ✓ Minimal periodic maintenance
- ✓ 1E qualification and embedded safety related software
- ✓ Available under 10 CFR 50 App. B, ASME NQA-1 and IEC61226 programs for safety related applications

# SAM 201K™ SPECTRUM ANALYSIS MONITOR

## PHYSICAL CHARACTERISTICS

- Radiation detected: gamma
- Detector: 1¼"x1" NaI(Tl) scintillator + PMT (SG/NAI 1¼"x1")
- Energy range: 100 keV to 7 MeV
- Spectrometry analysis: 1024 channels
- Typical measurement range: 6 decades between 3.7 10<sup>+2</sup> to 3.7 10<sup>+12</sup> Bq/m<sup>3</sup> (10<sup>-8</sup> to 10<sup>+2</sup> µCi/cc)

## ENVIRONMENTAL CHARACTERISTICS

- Normal temperature: +5 °C to +40 °C (+41 °F to +104 °F)
- Temperature limit:
  - Processing unit: -5 °C to +55 °C (+23 °F to +131 °F)
  - Detector and cable: -5 °C to +70 °C (+23 °F to +158 °F)
- MTBF (processing unit): > 50 000 hours
- TID :
  - Processing unit: 100 Gy (10<sup>+4</sup> rad)
  - Detector and cable: 10<sup>+3</sup> Gy (10<sup>+5</sup> rad)
- Protection index: IP65 and IK07

## MECHANICAL CHARACTERISTICS

- Dimensions:
  - Processing unit: 390 mm x 196 mm x 187 mm (15.3 in x 7.7 in x 7.3 in)
  - Detector: 329 mm x 388 mm x 513 mm (13 in x 15.3 in x 20.2 in)
- Weight:
  - Processing unit: 8 kg (17.6 lb)
  - Detector: 210 kg (463 lb)
- Color (processing unit): gray RAL 7030 (decontaminable paint)

## ELECTRICAL CHARACTERISTICS

- Power supply: 230 Vac – 50 Hz or 120 Vac – 60 Hz
- Data link outputs: one RS232 (LPDU only) and two isolated RS485
- Alarm relays: three SPDT relays
- I/O: two isolated analog outputs and one isolated analog input (0/4-20 mA)

## SIGNALING (APPLICABLE TO LPDU ONLY)

- Alphanumeric display: measurement, status...
- Sound alarm: buzzer 90 dBA at 1 meter
- Visual alarm: three lights (red, yellow, green)

## REFERENCE STANDARDS

- Environmental: IEC/IEEE 60780-323
- Seismic: IEC60980, IEEE344
- EMC: 2014/30/EU and 2014/35/EU, EPRI 102323, RG1.180, IEC61000-6-2 and IEC61000-6-4

## VERSIONS

- 230 Vac or 120 Vac
- Local processing and display unit (LPDU) or local processing unit (LPU)
- Without protection, 2 π/5 cm (2 π/2 in) or 4 π/5 cm (4 π/2 in) detector lead shield
- With or without RS485 junction box
- Detector cable length: from 20 m (65.6 ft) to 100 m (328 ft)
- Junction box cable length: 2 m (6.56 ft), 5 m (16.4 ft) or 10 m (32.8 ft)

## ACCESSORIES

- Calibration tools
- Software: MASS2™, RAMVISION™, SIMS2™ applications...
- USB converters
- Seismic qualified wall mounting bracket for LP(D)U
- Detection sub-assembly support



**MIRION**  
TECHNOLOGIES

Copyright © 2023 Mirion Technologies, Inc. or its affiliates. All rights reserved. Mirion, the Mirion logo, and other trade names of Mirion products listed herein are registered trademarks or trademarks of Mirion Technologies, Inc. or its affiliates in the United States and other countries. Third party trademarks mentioned are the property of their respective owners.



RAMSYS™

# SAM 202K™

## Spectrum Analysis Monitor

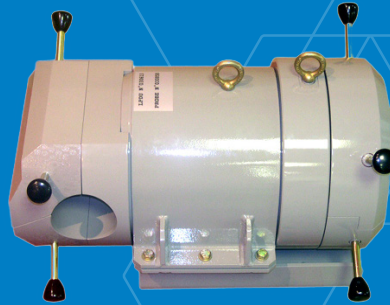

**Gamma spectra analysis with identification of isotopes. Available with a 3"x2" NaI(Tl) detector.**

### DESCRIPTION

The SAM 202K monitor forms part of the RAMSYS product line. It has been developed to detect gamma radiations and provide gamma spectra analysis with identification of isotopes.

The SAM 202K monitor is designed for continuous unattended operation and can cover most of the gamma measurement ranges required by regulations and industry guidelines. Four detector sizes are available which make this monitor very efficient and reliable, with high sensitivity, wide measurement range and fast response time.

### FEATURES

- ✓ Wide measurement range
- ✓ Can be used for various types of applications
- ✓ Minimal periodic maintenance
- ✓ 1E qualification and embedded safety related software
- ✓ Available under 10 CFR 50 App. B, ASME NQA-1 and IEC61226 programs for safety related applications

# SAM 202K™ SPECTRUM ANALYSIS MONITOR

## PHYSICAL CHARACTERISTICS

- Radiation detected: gamma
- Detector: 3"x2" NaI(Tl) scintillator + PMT (SG/NAI 3"x2")
- Energy range: 100 keV to 7 MeV
- Spectrometry analysis: 1024 channels
- Typical measurement range: 6 decades between  $3.7 \cdot 10^{+2}$  to  $3.7 \cdot 10^{+12}$  Bq/m<sup>3</sup> ( $10^{-8}$  to  $10^{+2}$   $\mu$ Ci/cc)

## ENVIRONMENTAL CHARACTERISTICS

- Normal temperature: +5 °C to +40 °C (+41 °F to +104 °F)
- Temperature limit:
  - Processing unit: -5 °C to +55 °C (+23 °F to +131 °F)
  - Detector and cable: -5 °C to +70 °C (+23 °F to +158 °F)
- MTBF (processing unit): > 50 000 hours
- TID :
  - Processing unit: 100 Gy ( $10^{+4}$  rad)
  - Detector and cable:  $10^{+3}$  Gy ( $10^{+5}$  rad)
- Protection index: IP65 and IK07

## MECHANICAL CHARACTERISTICS

- Dimensions:
  - Processing unit: 390 mm x 196 mm x 187 mm (15.3 in x 7.7 in x 7.3 in)
  - Detector: 329 mm x 388 mm x 513 mm (13 in x 15.3 in x 20.2 in)
- Weight:
  - Processing unit: 8 kg (17.6 lb)
  - Detector: 210 kg (463 lb)
- Color (processing unit): gray RAL 7030 (decontaminable paint)

## ELECTRICAL CHARACTERISTICS

- Power supply: 230 Vac – 50 Hz or 120 Vac – 60 Hz
- Data link outputs: one RS232 (LPDU only) and two isolated RS485
- Alarm relays: three SPDT relays
- I/O: two isolated analog outputs and one isolated analog input (0/4-20 mA)

## SIGNALING (APPLICABLE TO LPDU ONLY)

- Alphanumeric display: measurement, status...
- Sound alarm: buzzer 90 dBA at 1 meter
- Visual alarm: three lights (red, yellow, green)

## REFERENCE STANDARDS

- Environmental: IEC/IEE 60780-323
- Seismic: IEC60980, IEEE344
- EMC: 2014/30/EU and 2014/35/EU, EPRI 102323, RG1.180, IEC61000-6-2 and IEC61000-6-4

## VERSIONS

- 230 Vac or 120 Vac
- Local processing and display unit (LPDU) or local processing unit (LPU)
- Without protection, 2  $\pi$ /5 cm (2  $\pi$ /2 in) or 4  $\pi$ /5 cm (4  $\pi$ /2 in) detector lead shield
- With or without RS485 junction box
- Detector cable length: from 20 m (65.6 ft) to 100 m (328 ft)
- Junction box cable length: 2 m (6.56 ft), 5 m (16.4 ft) or 10 m (32.8 ft)

## ACCESSORIES

- Calibration tools
- Software: MASS2™, RAMVISION™, SIMS2™ applications...
- USB converters
- Seismic qualified wall mounting bracket for LP(D)U
- Detection sub-assembly support



**MIRION**  
TECHNOLOGIES

Copyright © 2024 Mirion Technologies, Inc. or its affiliates. All rights reserved. Mirion, the Mirion logo, and other trade names of Mirion products listed herein are registered trademarks or trademarks of Mirion Technologies, Inc. or its affiliates in the United States and other countries. Third party trademarks mentioned are the property of their respective owners.



RAMSYS™

# SAM 203K™

## Spectrum Analysis Monitor



**Gamma spectra analysis with identification of isotopes. Available with a 2"x2" NaI(Tl) detector.**

### DESCRIPTION

The SAM 203K monitor forms part of the RAMSYS product line. It has been developed to detect gamma radiations and provide gamma spectra analysis with identification of isotopes.

The SAM 203K monitor is designed for continuous unattended operation and can cover most of the gamma measurement ranges required by regulations and industry guidelines. Four detector sizes are available which make this monitor very efficient and reliable, with high sensitivity, wide measurement range and fast response time.

### FEATURES

- ✓ Wide measurement range
- ✓ Can be used for various types of applications
- ✓ Minimal periodic maintenance
- ✓ 1E qualification and embedded safety related software
- ✓ Available under 10 CFR 50 App. B, ASME NQA-1 and IEC61226 programs for safety related applications

# SAM 203K™ SPECTRUM ANALYSIS MONITOR

## PHYSICAL CHARACTERISTICS

- Radiation detected: gamma
- Detector: 2"x2" NaI(Tl) scintillator + PMT (SG/NAI 2"x2")
- Energy range: 100 keV to 7 MeV
- Spectrometry analysis: 1024 channels
- Typical measurement range: 6 decades between  $3.7 \cdot 10^{+2}$  to  $3.7 \cdot 10^{+12}$  Bq/m<sup>3</sup> ( $10^{-8}$  to  $10^{+2}$   $\mu$ Ci/cc)

## ENVIRONMENTAL CHARACTERISTICS

- Normal temperature: +5 °C to +40 °C (+41 °F to +104 °F)
- Temperature limit:
  - Processing unit: -5 °C to +55 °C (+23 °F to +131 °F)
  - Detector and cable: -5 °C to +70 °C (+23 °F to +158 °F)
- MTBF (processing unit): > 50 000 hours
- TID :
  - Processing unit: 100 Gy ( $10^{+4}$  rad)
  - Detector and cable:  $10^{+3}$  Gy ( $10^{+5}$  rad)
- Protection index: IP65 and IK07

## MECHANICAL CHARACTERISTICS

- Dimensions:
  - Processing unit: 390 mm x 196 mm x 187 mm (15.3 in x 7.7 in x 7.3 in)
  - Detector: 329 mm x 388 mm x 513 mm (13 in x 15.3 in x 20.2 in)
- Weight:
  - Processing unit: 8 kg (17.6 lb)
  - Detector: 210 kg (463 lb)
- Color (processing unit): gray RAL 7030 (decontaminable paint)

## ELECTRICAL CHARACTERISTICS

- Power supply: 230 Vac – 50 Hz or 120 Vac – 60 Hz
- Data link outputs: one RS232 (LPDU only) and two isolated RS485
- Alarm relays: three SPDT relays
- I/O: two isolated analog outputs and one isolated analog input (0/4-20 mA)

## SIGNALING (APPLICABLE TO LPDU ONLY)

- Alphanumeric display: measurement, status...
- Sound alarm: buzzer 90 dBA at 1 meter
- Visual alarm: three lights (red, yellow, green)

## REFERENCE STANDARDS

- Environmental: IEC/IEE 60780-323
- Seismic: IEC60980, IEEE344
- EMC: 2014/30/EU and 2014/35/EU, EPRI 102323, RG1.180, IEC61000-6-2 and IEC61000-6-4

## VERSIONS

- 230 Vac or 120 Vac
- Local processing and display unit (LPDU) or local processing unit (LPU)
- Without protection, 2  $\pi$ /5 cm (2  $\pi$ /2 in) or 4  $\pi$ /5 cm (4  $\pi$ /2 in) detector lead shield
- With or without RS485 junction box
- Detector cable length: from 20 m (65.6 ft) to 100 m (328 ft)
- Junction box cable length: 2 m (6.56 ft), 5 m (16.4 ft) or 10 m (32.8 ft)

## ACCESSORIES

- Calibration tools
- Software: MASS2™, RAMVISION™, SIMS2™ applications...
- USB converters
- Seismic qualified wall mounting bracket for LP(D)U
- Detection sub-assembly support



**MIRION**  
TECHNOLOGIES

Copyright © 2024 Mirion Technologies, Inc. or its affiliates. All rights reserved. Mirion, the Mirion logo, and other trade names of Mirion products listed herein are registered trademarks or trademarks of Mirion Technologies, Inc. or its affiliates in the United States and other countries. Third party trademarks mentioned are the property of their respective owners.

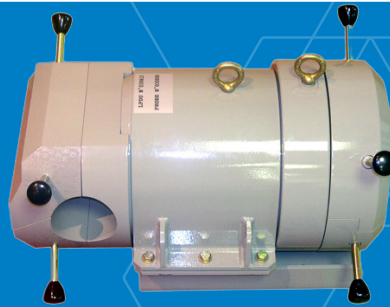

RAMSYS™

# SAM 204K™

## Spectrum Analysis Monitor

**Gamma spectra analysis with identification of isotopes. Available with a 3"x3" NaI(Tl) detector.**

### DESCRIPTION

The SAM 204K monitor forms part of the RAMSYS product line. It has been developed to detect gamma radiations and provide gamma spectra analysis with identification of isotopes.

The SAM 204K monitor is designed for continuous unattended operation and can cover most of the gamma measurement ranges required by regulations and industry guidelines. Four detector sizes are available which make this monitor very efficient and reliable, with high sensitivity, wide measurement range and fast response time.

### FEATURES

- ✓ Wide measurement range
- ✓ Can be used for various types of applications
- ✓ Minimal periodic maintenance
- ✓ 1E qualification and embedded safety related software
- ✓ Available under 10 CFR 50 App. B, ASME NQA-1 and IEC61226 programs for safety related applications

# SAM 204K™ SPECTRUM ANALYSIS MONITOR

## PHYSICAL CHARACTERISTICS

- Radiation detected: gamma
- Detector: 3"x3" NaI(Tl) scintillator + PMT (SG/NAI 3"x3")
- Energy range: 100 keV to 7 MeV
- Spectrometry analysis: 1024 channels
- Typical measurement range: 6 decades between  $3.7 \cdot 10^{+2}$  to  $3.7 \cdot 10^{+12}$  Bq/m<sup>3</sup> ( $10^{-8}$  to  $10^{+2}$   $\mu$ Ci/cc)

## ENVIRONMENTAL CHARACTERISTICS

- Normal temperature: +5 °C to +40 °C (+41 °F to +104 °F)
- Temperature limit:
  - Processing unit: -5 °C to +55 °C (+23 °F to +131 °F)
  - Detector and cable: -5 °C to +70 °C (+23 °F to +158 °F)
- MTBF (processing unit): > 50 000 hours
- TID :
  - Processing unit: 100 Gy ( $10^{+4}$  rad)
  - Detector and cable:  $10^{+3}$  Gy ( $10^{+5}$  rad)
- Protection index: IP65 and IK07

## MECHANICAL CHARACTERISTICS

- Dimensions:
  - Processing unit: 390 mm x 196 mm x 187 mm (15.3 in x 7.7 in x 7.3 in)
  - Detector: 329 mm x 388 mm x 513 mm (13 in x 15.3 in x 20.2 in)
- Weight:
  - Processing unit: 8 kg (17.6 lb)
  - Detector: 210 kg (463 lb)
- Color (processing unit): gray RAL 7030 (decontaminable paint)

## ELECTRICAL CHARACTERISTICS

- Power supply: 230 Vac – 50 Hz or 120 Vac – 60 Hz
- Data link outputs: one RS232 (LPDU only) and two isolated RS485
- Alarm relays: three SPDT relays
- I/O: two isolated analog outputs and one isolated analog input (0/4-20 mA)

## SIGNALING (APPLICABLE TO LPDU ONLY)

- Alphanumeric display: measurement, status...
- Sound alarm: buzzer 90 dBA at 1 meter
- Visual alarm: three lights (red, yellow, green)

## REFERENCE STANDARDS

- Environmental: IEC/IEE 60780-323
- Seismic: IEC60980, IEEE344
- EMC: 2014/30/EU and 2014/35/EU, EPRI 102323, RG1.180, IEC61000-6-2 and IEC61000-6-4

## VERSIONS

- 230 Vac or 120 Vac
- Local processing and display unit (LPDU) or local processing unit (LPU)
- Without protection, 2  $\pi$ /5 cm (2  $\pi$ /2 in) or 4  $\pi$ /5 cm (4  $\pi$ /2 in) detector lead shield
- With or without RS485 junction box
- Detector cable length: from 20 m (65.6 ft) to 100 m (328 ft)
- Junction box cable length: 2 m (6.56 ft), 5 m (16.4 ft) or 10 m (32.8 ft)

## ACCESSORIES

- Calibration tools
- Software: MASS2™, RAMVISION™, SIMS2™ applications...
- USB converters
- Seismic qualified wall mounting bracket for LP(D)U
- Detection sub-assembly support



**MIRION**  
TECHNOLOGIES

Copyright © 2024 Mirion Technologies, Inc. or its affiliates. All rights reserved. Mirion, the Mirion logo, and other trade names of Mirion products listed herein are registered trademarks or trademarks of Mirion Technologies, Inc. or its affiliates in the United States and other countries. Third party trademarks mentioned are the property of their respective owners.





RAMSYS™

# GIM 201K™

## Low Range Gamma Area Monitor

Low range gamma area monitor developed to monitor absorbed equivalent dose rate in nuclear facilities or laboratories for personnel exposure.

### DESCRIPTION

The GIM 201K monitor forms part of the RAMSYS product line.

It has been developed to monitor absorbed dose rate in nuclear facilities for personnel exposure. Its design makes it especially suited for operation in accelerators.

Ionization chamber made of high density polyethylene allows the measure of short duration pulsed radiation fields when halogenated and/or material activation is an issue operating conditions.



### FEATURES

- ✓ Wide measurement range
- ✓ High detector TID
- ✓ Up to 150 meters (492 ft) between detector and processing unit
- ✓ Available with or without display and local signaling
- ✓ Suitable for continuous and pulsed radiation fields
- ✓ Compact and reliable

# GIM 201K™ LOW RANGE GAMMA AREA MONITOR

## PHYSICAL CHARACTERISTICS

- Radiation detected: gamma
- Detector: plastic (HDPE) ionization chamber (SG/IC21)
- Energy range: 50 keV to 7 MeV
- Typical measurement range: 10<sup>-6</sup> to 10 Sv/h
- (10<sup>-4</sup> to 10<sup>+3</sup> rem/h)

## ENVIRONMENTAL CHARACTERISTICS

- Normal temperature: +5 °C to +40 °C (+41 °F to +104 °F)
- Temperature limit:
  - Processing unit: -5 °C to +55 °C (+23 °F to +131 °F)
  - Detector: -40 °C to +55 °C (-40 °F to +131 °F)
- MTBF: > 50 000 hours
- TID:
  - Processing unit: 100 Gy (10<sup>+4</sup> rad)
  - Detector: 10<sup>+5</sup> Gy (10<sup>+7</sup> rad)
- Protection index: IP65 and IK07

## MECHANICAL CHARACTERISTICS

- Dimensions:
  - Processing unit: 390 mm x 196 mm x 187 mm (15.3 in x 7.7 in x 7.3 in)
  - Detector: 288 mm (11.3 in) x Ø 160 mm (6.3 in)
- Weight:
  - Processing unit: 8.5 kg (18.7 lb)
  - Detector: 1 kg (2.2 lb)
- Color:
  - Processing unit: gray RAL 7030 (decontaminable paint)
  - Detector: matt black (decontaminable paint)

## ELECTRICAL CHARACTERISTICS

- Power supply: 230 Vac – 50 Hz or 120 Vac – 60 Hz
- Data link outputs: one RS232 (LPDU only) and two isolated RS485
- Alarm relays: three SPDT relays
- I/O: two isolated analog outputs and one isolated analog input (0/4-20 mA)

## SIGNALING (APPLICABLE TO LPDU ONLY)

- Alphanumeric display: measurement, status...
- Sound alarm: buzzer 90 dBA at 1 meter
- Visual alarm: three lights (red, yellow, green)

## REFERENCE STANDARDS

- Nuclear: IEC 60532
- Environmental: IEC/IEEE 60780-323
- Seismic: IEEE 344 and IEC 60980
- EMC: 2014/30/EU and 2014/35/EU, EPRI 102323, RG 1.180, IEC 61000-6-2 and IEC 61000-6-4

## VERSIONS

- 230 Vac or 120 Vac
- Local processing and display unit (LPDU) or local processing unit (LPU)
- With or without RS485 junction box
- Detector cable length: from 10 m (32.8 ft) to 150 m (492 ft)
- Junction box cable length: 2 m (6.56 ft), 5 m (16.4 ft) or 10 m (32.8 ft)

## ACCESSORIES

- Calibration tools
- Software: MASS2™, RAMVISION™, SIMS2™ applications...
- Ethernet (LPDU version only)
- USB converters
- Seismic qualified wall mounting brackets (for electronics and detector)



**MIRION**  
TECHNOLOGIES

Copyright © 2024 Mirion Technologies, Inc. or its affiliates. All rights reserved. Mirion, the Mirion logo, and other trade names of Mirion products listed herein are registered trademarks or trademarks of Mirion Technologies, Inc. or its affiliates in the United States and other countries. Third party trademarks mentioned are the property of their respective owners.



CAMSYS™

# G64™

## Area Gamma Monitor

Compact, mains-powered, microprocessor-based radiation monitor, designed specifically for area and process monitoring in nuclear facilities.

### DESCRIPTION

The G64 monitor is intended for installed use but can also be used on a bench stand or wheeled trolley to provide temporary monitoring or to supplement permanently installed monitors during maintenance activities. The only requirements of the basic system are a G64 monitor, suitably mounted, and a mains power supply in the range 100-240 VAC. The standard G64 is supplied with a compact solid state detector for use in low to medium dose rate applications. The detector is directly mounted on top of the display/alarm unit. For remote monitoring applications, the detector assembly can be easily dismantled from the display/alarm unit and installed at distances of up to 100 m (328 ft) using a remote detector kit. The user must simply ensure that connections between the detector and the G64 display/alarm unit are corrects, and that the detector is mounted using the wall mounting bracket supplied.

The G64 monitor is also available in three other versions for additional applications:

- G64IC™: for high dose rate and high integrated dose applications
- G64SC™: intended for use with existing scintillation detectors
- G64SI™: intended for use with existing silicon detectors

**G64™ AREA GAMMA MONITOR**



### FEATURES

- ✓ Pseudo-logarithmic ratemeter averaging for good statistics at low level and fast response at high levels
- ✓ Removable detector unit for remote use
- ✓ Three user-set alarm levels across the full range
- ✓ Local signalling by audio and visual alarms
- ✓ Remote signalling by relays
- ✓ Displays on high visibility LCD, status, fault and alarm messages
- ✓ Interlock monitor functionality (SIL2)
- ✓ Front panel RS-232 port for configuration by local PC or optional iConfig PDA

# G64™ GAMMA AREA MONITOR

## PHYSICAL CHARACTERISTICS

- Radiation detected: gamma
- Detector: solid state detector, ion chamber, scintillation or silicon
- Response time: < 6 seconds to 90% of final step change value
- Dynamic range:
  - Solid state detector: 0.1 µSv/h to 100 mSv/h (10 µR/h to 10 R/h)
  - Ion chamber: 0.1 mSv/h to 100 Sv/hr (0.01 R/h to 10 kR/h)
  - Scintillator: 0.1 cps - 100 kcps
- Energy response:
  - Solid state detector: 70 keV to 7 MeV ± 30% normalized to <sup>137</sup>Cs
  - Ion chamber: 100 keV to 1.25 MeV
  - Scintillator: > 100 KeV

## ENVIRONMENTAL CHARACTERISTICS

- Operating temperature: 0 °C to +40 °C (+32 °F to +104 °F)
- Humidity range: up to 85%, non-condensing
- Protection index:
  - Solid state detector: IP65 when locally mounted, IP54 if remote
  - Ion chamber: IP65
  - Scintillator: IP42 (detector), IP65 (pre-amplifier)
  - Display and alarm unit: IP54 (Cat 2)

## MECHANICAL CHARACTERISTICS

- Dimensions:
  - Solid state detector: 85 mm x 75 mm x 60 mm (3.3 in x 2.9 in x 2.4 in)
  - Display and alarm unit: 445 mm x 175 mm x 100 mm (17.5 in x 6.9 in x 3.9 in)
- Weight:
  - Solid state detector: 0.5 kg (1.1 lb)
  - Display and alarm unit: 3.5 kg (7.7 lb)

## ELECTRICAL CHARACTERISTICS

- Power supply: 100-240 VAC 35 VA internal back-up battery (rechargeable) giving > 30 min backup
- Outputs:
  - Three fail-safe relays for faults and alarms, each with two sets of changeover contacts
  - RS232/RS485 interfaces and RS422 format pulse output
  - Current loop (4-20 mA)

## SIGNALING

- Red beacon: LED, flashing at 1 Hz for activity alarm
- Green beacon: LED, continuous illumination for normal operation; flashing at 1 Hz for system fault
- Sounder: separate tones for activity and fault alarms; various tones selected by the user

## REFERENCE STANDARDS

- Radiological: IEC 60532 installed dose rate meters, warning assemblies and monitors for X- and gamma radiations of energy between 50 keV and 7 MeV (2010)
- IEC 61508 (SIL1)
- Interlocking system (SIL2)

## VERSIONS

- G64: G64 area monitor with solid state detector (EU, UK and US versions)
- G64IC: high dose rate area monitor version with 10 m, 25 m or 50 m (33 ft, 82 ft or 164 ft) screened twisted pair cable from amplifier to G64 controller
- G64SC: cooling water monitor (excludes detector) with 10 m, 25 m or 50 m (33 ft, 82 ft or 164 ft) screened twisted pair cable from amplifier to G64 controller

## ACCESSORIES

- Bench stand or trolley mountings
- Remote detector kits (10 m, 25 m or 100 m - 33 ft, 82 ft or 330 ft)
- Test pulse generator
- iConfig configuration software



**MIRION**  
TECHNOLOGIES

Copyright © 2023 Mirion Technologies, Inc. or its affiliates. All rights reserved. Mirion, the Mirion logo, and other trade names of Mirion products listed herein are registered trademarks or trademarks of Mirion Technologies, Inc. or its affiliates in the United States and other countries. Third party trademarks mentioned are the property of their respective owners.



RAMSYS™

# GIM 204K™

## Very Wide Range Gamma Area Monitor

Monitoring dose rate in nuclear facilities for personnel exposure or for process monitoring.

### DESCRIPTION

The GIM 204K monitor forms part of the RAMSYS product line. It has been developed to monitor dose rate or equivalent dose rate in nuclear facilities for personnel exposure as well as for process monitoring.

This monitor is available in many versions: with or without display, integral or remote detector, dose rate or equivalent dose rate, fixed or portable, etc.



### FEATURES

- ✓ Wide measurement range
- ✓ Compact and reliable
- ✓ Available with or without display and local signaling
- ✓ 1E qualification and embedded safety related software
- ✓ Available under 10 CFR 50 App. B, ASME NQA-1 and IEC 61226 programs for safety related applications

# GIM 204K™ VERY WIDE RANGE GAMMA AREA MONITOR

## PHYSICAL CHARACTERISTICS

- Radiation detected: gamma
- Detector: silicon (SG/Si(R)11 for Sv/h or SG/Si(R)21 for Gy/h)
- Energy range: 60 keV to 3 MeV
- Typical measurement range (according to IEC60532):  
10<sup>-6</sup> to 100 Gy/h or Sv/h (10<sup>-4</sup> to 10<sup>+4</sup> rad/h or rem/h)
- Measurement capability range: 10<sup>-8</sup> to 10<sup>+3</sup> Gy/h or Sv/h  
(10<sup>-6</sup> to 10<sup>+5</sup> rad/h or rem/h)

## ENVIRONMENTAL CHARACTERISTICS

- Normal temperature: +5 °C to +40 °C (+41 °F to +104 °F)
- Temperature limit:
  - Processing unit: -5 °C to +55 °C (+23 °F to +131 °F)
  - Detector: -20 °C to +55 °C (-4 °F to +131 °F)
- MTBF: > 50 000 hours
- TID:
  - Processing unit: 100 Gy (10<sup>+4</sup> rad)
  - Detector: 500 Gy (5 10<sup>+4</sup> rad)
- Protection index: IP65 and IK07

## MECHANICAL CHARACTERISTICS

- Dimensions:
  - Processing unit: 391 mm x 196 mm x 209 mm  
(15.4 in x 7.7 in x 8.2 in)
  - Detector: 08 mm x 92 mm x 166 mm  
(4.3 in x 3.6 in x 6.5 in)
- Weight:
  - Processing unit: 8 kg (17.6 lb)
  - Detector: 0.6 kg (1.3 lb)
- Color: gray RAL 7030 (decontaminable paint)

## ELECTRICAL CHARACTERISTICS

- Power supply: 230 Vac – 50 Hz or 120 Vac – 60 Hz
- Data link outputs: one RS232 and two isolated RS485
- Alarm relays: three SPDT relays
- I/O: two isolated analog outputs and one isolated analog input  
(0/4-20 mA)

## SIGNALING (APPLICABLE TO LPDU ONLY)

- Alphanumeric display: measurement, status...
- Sound alarm: buzzer 90 dBA at 1 meter
- Visual alarm: three lights (red, yellow, green)

## REFERENCE STANDARDS

- Nuclear: IEC 60532
- Environmental: IEC/IEEE 60780-323
- Seismic: IEEE 344 and IEC 60980
- EMC: 2014/30/EU and 2014/35/EU, IEPRI 102323, RG 1.180,  
IEC 61000-6-2 and IEC 61000-6-4

## VERSIONS

- 230 Vac or 120 Vac
- Local processing and display unit (LPDU) or local processing unit (LPU)
- With or without RS485 junction box
- Detector cable length: from 5 m (16.4 ft) to 100 m (328 ft)
- Junction box cable length: 2 m (6.56 ft), 5 m (16.4 ft) or 10 m (32.8 ft)
- Detector calibrated in Sv/h (Si11) or Gy/h (Si21)

## ACCESSORIES

- Calibration tools
- Software: MASS2™, RAMVISION™, SIMS2™ applications...
- Ethernet (LPDU version only)
- USB converters
- Wall mounting bracket
- Carrying handle (GIM 204M™ mobile version)



**MIRION**  
TECHNOLOGIES

Copyright © 2023 Mirion Technologies, Inc. or its affiliates. All rights reserved. Mirion, the Mirion logo, and other trade names of Mirion products listed herein are registered trademarks or trademarks of Mirion Technologies, Inc. or its affiliates in the United States and other countries. Third party trademarks mentioned are the property of their respective owners.



RAMSYS™

# GIM 205K™

## Medium Range Gamma Area Monitor



**Monitoring of dose rate in nuclear facilities for process monitoring. Perfect for sump monitoring.**

### DESCRIPTION

The GIM 205K monitor forms part of the RAMSYS product line. It has been developed to monitor dose rate in nuclear facilities for process monitoring. Its ionization chamber is waterproof and makes it perfectly suitable for sump monitoring.

A version based on a differential ionization chamber allows for compensation of the ambient background.

### FEATURES

- ✓ Wide measurement range
- ✓ Wide detector and cable temperature range
- ✓ High detector and cable TID
- ✓ Compact and reliable
- ✓ Available with or without display and local signaling
- ✓ Waterproof detector
- ✓ Indoor and outdoor applications

# GIM 205K™ MEDIUM RANGE GAMMA AREA MONITOR

## PHYSICAL CHARACTERISTICS

- Radiation detected: gamma
- Detector: stainless steel ionization chamber (SG/IC41 or SG/ICD41)
- Energy range: 87 keV to 7 MeV
- Typical measurement range:  $10^{-5}$  to  $10^{+3}$  Gy/h ( $10^{-3}$  to  $10^{+5}$  rad/h)

## ENVIRONMENTAL CHARACTERISTICS

- Normal temperature: +5 °C to +40 °C (+41 °F to +104 °F)
- Temperature limit:
  - Processing unit: -5 °C to +55 °C (+23 °F to +131 °F)
  - Detector and cable: -5 °C to +70 °C (+23 °F to +158 °F)
- MTBF: > 50 000 hours
- TID:
  - Processing unit: 100 Gy ( $10^{+4}$  rad)
  - Detector and cable:  $5 \cdot 10^{+4}$  Gy ( $5 \cdot 10^{+6}$  rad)
- Protection index:
  - Processing unit: IP65 and IK07
  - Detector: IP65, IP67 and IK07

## MECHANICAL CHARACTERISTICS

- Dimensions:
  - Processing unit: 370 mm x 196 mm x 187 mm (14.6 in x 7.7 in x 7.3 in)
  - Detector:  $\varnothing$  63.5 mm (2.5 in) x 174 mm (6.8 in)
- Weight:
  - Processing unit: 8.5 kg (18.7 lb)
  - Detector (SG/IC41): 2 kg (4.4 lb)
- Color (processing unit): gray RAL 7030 (decontaminable paint)

## ELECTRICAL CHARACTERISTICS

- Power supply: 230 Vac – 50 Hz or 120 Vac – 60 Hz
- Data link outputs: one RS232 and two isolated RS485
- Alarm relays: three SPDT relays
- I/O: two isolated analog outputs and one isolated analog input (0/4-20 mA)

## SIGNALING (APPLICABLE TO LPDU ONLY)

- Alphanumeric display: measurement, status...
- Sound alarm: buzzer 90 dBA at 1 meter
- Visual alarm: three lights (red, yellow, green)

## REFERENCE STANDARDS

- EMC: 2014/30/EU and 2014/35/EU, EPRI 102323, RG 1.180, IEC 61000-6-2 and IEC 61000-6-4

## VERSIONS

- 230 Vac or 120 Vac
- Local processing and display unit (LPDU) or local processing unit (LPU)
- With or without RS485 junction box
- Detector cable length: from 5 m (16.4 ft) to 50 m (164 ft)
- Junction box cable length: 2 m (6.56 ft), 5 m (16.4 ft) or 10 m (32.8 ft)
- Differential chamber (SG/ICD41) for dynamic background compensation

## ACCESSORIES

- Calibration tools
- Software: MASS2™, RAMVISION™, SIMS2™ applications...
- USB converters
- Seismic qualified wall mounting bracket



**MIRION**  
TECHNOLOGIES

Copyright © 2023 Mirion Technologies, Inc. or its affiliates. All rights reserved. Mirion, the Mirion logo, and other trade names of Mirion products listed here in are registered trademarks or trademarks of Mirion Technologies, Inc. or its affiliates in the United States and other countries. Third party trademarks mentioned are the property of their respective owners.





RAMSYS™

# GIM 202K™

## Wide Range Gamma Area Monitor

Continuous monitoring of gamma dose rate under mild or post-accident environmental conditions.

### DESCRIPTION

The GIM 202K monitor forms part of the RAMSYS product line. It has been developed to monitor kerma dose rate (in Gy/h or rad/h) or ambient equivalent dose rate  $H(*10)$  (in Sv/h or rem/h) in nuclear facilities under mild operating or post-accident conditions.

The very simple concept of its ionization chamber allows this monitor to have a great reliability of prime importance in the safety related applications.



### FEATURES

- ✓ Wide measurement range
- ✓ Compact and reliable
- ✓ Available with or without display and local signalling
- ✓ Available under 10 CFR 50 App. B, ASME NQA-1 and IEC 61226 programs for safety related applications

# GIM 202K™ WIDE RANGE GAMMA AREA MONITOR

## PHYSICAL CHARACTERISTICS

- Radiation detected: gamma
- Detector: stainless steel ionization chamber (KG 220 SEF-Gy for Gy/h or KG 220 SEF-Sv for Sv/h)
- Energy range: 80 keV to 1.5 MeV according to IEC60532
- Energy range capability: up to 7 MeV ( $\pm 60\%$ )
- Typical measurement range:  $10^{-7}$  to  $10^{+2}$  Gy/h or Sv/h ( $10^{-5}$  to  $10^{+4}$  rad/h or rem/h)

## ENVIRONMENTAL CHARACTERISTICS

- Normal temperature:
  - Processing unit:  $+5\text{ }^{\circ}\text{C}$  to  $+40\text{ }^{\circ}\text{C}$  ( $+41\text{ }^{\circ}\text{F}$  to  $+104\text{ }^{\circ}\text{F}$ )
  - Detector:  $-30\text{ }^{\circ}\text{C}$  to  $+100\text{ }^{\circ}\text{C}$  ( $-22\text{ }^{\circ}\text{F}$  to  $+212\text{ }^{\circ}\text{F}$ )
- Temperature limit:
  - Processing unit:  $-5\text{ }^{\circ}\text{C}$  to  $+55\text{ }^{\circ}\text{C}$  ( $+23\text{ }^{\circ}\text{F}$  to  $+131\text{ }^{\circ}\text{F}$ )
  - Detector:  $+120\text{ }^{\circ}\text{C}$  ( $+248\text{ }^{\circ}\text{F}$ ) during 1 hour
- MTBF: > 50 000 hours
- TID:
  - Processing unit: 100 Gy ( $10^{+4}$  rad)
  - Detector:  $2.5\ 10^{+5}$  Gy ( $2.5\ 10^{+7}$  rad)
- Protection index:
  - Processing unit: IP65 and IK07
  - Detector: IP65, IP67 and IK07

## MECHANICAL CHARACTERISTICS

- Dimensions:
  - Processing unit: 390 mm x 196 mm x 187 mm (15.3 in x 7.7 in x 7.3 in)
  - Detector: 240 mm (9.5 in) x  $\varnothing$  280 mm (11 in)
- Weight:
  - Processing unit: 8.5 kg (18.7 lb)
  - Detector: 23 kg (51 lb)
- Color: gray RAL 7030 (decontaminable paint)

## ELECTRICAL CHARACTERISTICS

- Power supply: 230 Vac – 50 Hz or 120 Vac – 60 Hz
- Data link outputs: one RS232 (LPDU only) and two isolated RS485
- Alarm relays: three SPDT relays
- I/O: two isolated analog outputs and one isolated analog input (0/4-20 mA)

## SIGNALING (APPLICABLE TO LPDU ONLY)

- Alphanumeric display: measurement, status...
- Sound alarm: buzzer 90 dBA at 1 meter
- Visual alarm: three lights (red, yellow, green)

## REFERENCE STANDARDS

- Nuclear: IEC 60532
- Environmental: IEC/IEEE 60780-323
- Seismic: IEEE 344 and IEC 60980
- EMC: 2014/30/EU and 2014/35/EU, EPRI 102323, RG 1.180, IEC 61000-6-2 and IEC 61000-6-4

## VERSIONS

- 230 Vac or 120 Vac
- Local processing and display unit (LPDU) or local processing unit (LPU)
- KG 220 SEF-Gy or KG 220 SEF-Sv
- With or without RS485 junction box
- Detector cable length: from 10 m (32.8 ft) to 70 m (229.6 ft)
- Junction box cable length: 2 m (6.56 ft), 5 m (16.4 ft) or 10 m (32.8 ft)

## ACCESSORIES

- Calibration tools
- Software: MASS2™, RAMVISION™, SIMS2™ applications...
- Ethernet (LPDU version only)
- USB converters
- Seismic qualified wall mounting bracket



**MIRION**  
TECHNOLOGIES

Copyright © 2024 Mirion Technologies, Inc. or its affiliates. All rights reserved. Mirion, the Mirion logo, and other trade names of Mirion products listed herein are registered trademarks or trademarks of Mirion Technologies, Inc. or its affiliates in the United States and other countries. Third party trademarks mentioned are the property of their respective owners.



RAMSYS™

# GIM 203K™

## Wide Range Gamma Area Monitor

**Continuous monitoring of gamma dose rate under harsh or post-accident environmental conditions.**

### DESCRIPTION

The GIM 203K monitor forms part of the RAMSYS product line. It has been developed to continuously monitor gamma dose rate under harsh environment conditions.

It is particularly useful for monitoring the dose rate inside containment and in the reactor building during and after mild and severe accidents under harsh operating conditions.



### FEATURES

- ✓ Wide measurement range
- ✓ Compact and reliable
- ✓ Available with or without display and local signaling
- ✓ 1E qualification and embedded safety related software
- ✓ Available under 10 CFR 50 App.B, ASME NQA-1 and IEC61226 programs for safety related applications
- ✓ LOCA proof detector and cable
- ✓ Very high TID
- ✓ Seismic qualification

# GIM 203K™ WIDE RANGE GAMMA AREA MONITOR

## PHYSICAL CHARACTERISTICS

- Radiation detected: gamma
- Detector: stainless steel ionization chamber (KG 221 SER-Sv)
- Energy range: 80 keV to 7 MeV
- Typical measurement range:  $10^{-6}$  to  $10^{+3}$  Sv/h ( $10^{-4}$  to  $10^{+5}$  rem/h)

## ENVIRONMENTAL CHARACTERISTICS

- Normal temperature:
  - Processing unit: +5 °C to +40 °C (+41 °F to +104 °F)
  - Detector: -5 °C to +135 °C (+23 °F to +275 °F)
- Temperature limit:
  - Processing unit: -5 °C to +55 °C (+23 °F to +131 °F)
- LOCA profile (detector):
  - Temperature: +165 °C (329 °F) during 12 hours
  - Temperature: +225 °C (437 °F) during 2 seconds
  - Pressure: 7 bars abs. during 12 hours
  - Tested under saturated steam conditions
  - Resistant to chemical spray
- MTBF: > 50 000 hours, with preventive maintenance
- TID:
  - Processing unit: 100 Gy ( $10^{+4}$  rad)
  - Detector:  $2 \times 10^{+6}$  Gy ( $2 \times 10^{+8}$  rad)
- Protection index:
  - Processing unit: IP65 and IK07
  - Detector: IP67 and IK07

## MECHANICAL CHARACTERISTICS

- Dimensions:
  - Processing unit: 390 mm x 196 mm x 187 mm (15.3 in x 7.7 in x 7.3 in)
  - Detector: 240 mm (9.5 in) x Ø 280 mm (11 in)
- Weight:
  - Processing unit: 8.5 kg (18.7 lb)
  - Detector: 24 kg (53 lb)
- Color: gray RAL 7030 (decontaminable paint)

## ELECTRICAL CHARACTERISTICS

- Power supply: 230 Vac – 50 Hz or 120 Vac – 60 Hz
- Data link outputs: one RS232 (LPDU only) and two isolated RS485
- Alarm relays: three SPDT relays
- I/O: two isolated analog outputs and one isolated analog input (0/4-20 mA)

## SIGNALING (APPLICABLE TO LPDU ONLY)

- Alphanumeric display: measurement, status...
- Sound alarm: buzzer 90 dBA at 1 meter
- Visual alarm: three lights (red, yellow, green)

## REFERENCE STANDARDS

- Nuclear: IEC60532
- Environmental: IEC/IEEE 60780-323, including LOCA test
- Seismic: IEEE344 and IEC60980
- EMC: 2014/30/EU and 2014/35/EU, IEPRI 102323, RG1.180, IEC61000-6-2 and IEC61000-6-4

## VERSIONS

- 230 Vac or 120 Vac
- Local processing and display unit (LPDU) or local processing unit (LPU)
- With or without RS485 junction box
- Mineral or organic detector cable
- Detector cable length: from 10 m (32.8 ft) to 70 m (229.6 ft); length up to 140 m (459.3 ft) is also possible, by means of two sets of mineral extension cables
- Junction box cable length: 2 m (5.65 ft), 5 m (16.4 ft) or 10 m (32.8 ft)

## ACCESSORIES

- Radioactive test sources for regular detector check available (e.g. TKA 16)
- Software: MASS2™, RAMVISION™, SIMS2™ applications...
- Ethernet (LPDU version only)
- USB converters
- Seismic qualified wall mounting bracket



**MIRION**  
TECHNOLOGIES

Copyright © 2025 Mirion Technologies, Inc. or its affiliates. All rights reserved. Mirion, the Mirion logo, and other trade names of Mirion products listed herein are registered trademarks or trademarks of Mirion Technologies, Inc. or its affiliates in the United States and other countries. Third party trademarks mentioned are the property of their respective owners.



RAMSYS™

# GIM 206K™

## High Range Gamma Area Monitor

Continuously monitoring dose rate under harsh or post-accident environmental conditions.

### DESCRIPTION

The GIM 206K monitor forms part of the RAMSYS product line.

It has been developed and qualified to monitor gamma dose rate during accident and post accident conditions, inside or outside containment of nuclear power plants. The design of the ionization chamber of this monitor provides great reliability for safety applications.



### FEATURES

- ✓ Wide measurement range
- ✓ Compact and reliable
- ✓ Available with or without display and local signaling
- ✓ 1E qualification and embedded safety related software
- ✓ Available under 10 CFR 50 App.B, ASME NQA-1 and IEC61226 programs for safety related applications
- ✓ LOCA proof detector and cable
- ✓ Very high TID
- ✓ Seismic qualification

# GIM 206K™ HIGH RANGE GAMMA AREA MONITOR

## PHYSICAL CHARACTERISTICS

- Radiation detected: gamma
- Detector: stainless ionization chamber with  $^{241}\text{Am}$  (1 kBq) embedded source (KG 50 SEC-2)
- Energy range: 60 keV to 7 MeV
- Measurement capability:  $10^{-3}$  to  $10^{+5}$  Gy/h ( $10^{-1}$  to  $10^{+7}$  rad/h)

## ENVIRONMENTAL CHARACTERISTICS

- Normal temperature:
  - Processing unit: +5 °C to +40 °C (+41 °F to +104 °F)
  - Detector: -5 °C to +135 °C (+23 °F to +275 °F)
- Temperature limit:
  - Processing unit: -5 °C to +55 °C (+23 °F to +131 °F)
- LOCA profile (detector):
  - Temperature: +165 °C (329 °F) during 12 hours
  - Temperature: +225 °C (437 °F) during 2 seconds
  - Pressure: 7 bars abs. during 12 hours
  - Tested under saturated steam conditions
  - Resistant to chemical spray
- MTBF: > 50 000 hours, with preventive maintenance
- TID:
  - Processing unit: 100 Gy ( $10^{+4}$  rad)
  - Detector:  $2 \cdot 10^{+6}$  Gy ( $2 \cdot 10^{+8}$  rad)
- Protection index:
  - Processing unit: IP65 and IK07
  - Detector: IP67, IP65 and IK07

## MECHANICAL CHARACTERISTICS

- Dimensions:
  - Processing unit: 398 mm x 196 mm x 187 mm (17.7 in x 7.7 in x 7.36 in)
  - Detector: 440 mm (17.3 in) x  $\varnothing$  50.8 mm (2 in)
- Weight:
  - Processing unit: 8.5 kg (18.7 lb)
  - Detector: 2.7 kg (5.95 lb)
- Color: gray RAL 7030 (decontaminable paint)

## ELECTRICAL CHARACTERISTICS

- Power supply: 230 Vac – 50 Hz or 120 Vac – 60 Hz
- Data link outputs: one RS232 (LPDU only) and two isolated RS485
- Alarm relays: three SPDT relays
- I/O: two isolated analog outputs and one isolated analog input (0/4-20 mA)

## SIGNALING (APPLICABLE TO LPDU ONLY)

- Alphanumeric display: measurement, status...
- Sound alarm: buzzer 90 dBA at 1 meter
- Visual alarm: three lights (red, yellow, green)

## REFERENCE STANDARDS

- Nuclear: IEC60951-1 and IEC60951-3
- Environmental: IEC/IEEE 60780-323, including LOCA test, RG 1.97
- Seismic: IEEE344 and IEC60980
- EMC: 2014/30/EU and 2014/35/EU, IEPRI 102323, RG1.180, IEC61000-6-2 and IEC61000-6-4

## VERSIONS

- 230 Vac or 120 Vac
- Local processing and display unit (LPDU) or local processing unit (LPU)
- With or without RS485 junction box
- Mineral or organic detector cable
- Detector cable length: from 10 m (32.8 ft) to 70 m (229.6 ft); length up to 140 m (459.3 ft) is also possible, by means of two sets of mineral extension cables
- Junction box cable length: 2 m (5.65 ft), 5 m (16.4 ft) or 10 m (32.8 ft)

## ACCESSORIES

- Radioactive test sources for regular detector check available (e.g. GAM 120)
- Software: MASS2™, RAMVISION™, SIMS2™ applications...
- Ethernet (LPDU version only)
- USB converters
- Seismic qualified wall mounting bracket for LP(D)U



**MIRION**  
TECHNOLOGIES

Copyright © 2023 Mirion Technologies, Inc. or its affiliates. All rights reserved. Mirion, the Mirion logo, and other trade names of Mirion products listed herein are registered trademarks or trademarks of Mirion Technologies, Inc. or its affiliates in the United States and other countries. Third party trademarks mentioned are the property of their respective owners.



RAMSYS™

# BIM 201K™

## Beta Irradiation Monitor



**In-line monitor designed to detect beta radiation in process and effluent lines in nuclear power plant or nuclear facilities.**

### DESCRIPTION

The BIM 201K irradiation monitor forms part of the RAMSYS product line. It's an in-line monitor designed to detect beta radiations in process and effluent lines in nuclear power plants or nuclear facilities.

The BIM 201K monitor has been developed for continuous unattended operation and can cover beta measurement ranges required by regulations and industry guidelines. It is mainly adapted for in-line monitoring to continuously measure beta volumetric activity in gaseous effluent.

### FEATURES

- ✓ Wide measurement range
- ✓ Wide temperature range detector
- ✓ Available with or without display and local signaling
- ✓ Compact and reliable
- ✓ 1E qualification and embedded safety related software
- ✓ Available under 10 CFR 50 App. B, IEC 61226 and ASME NQA-1 programs for safety related application

# BIM 201K™ BETA IRRADIATION MONITOR

## PHYSICAL CHARACTERISTICS

- Radiation detected: beta
- Detector: 2" thin plastic beta scintillator + PMT + embedded LED (SB 70)
- Energy range: > 30 keV
- Typical measurement range:  $3.7 \cdot 10^{+3}$  to  $3.7 \cdot 10^{+9}$  Bq/m<sup>3</sup> ( $10^{-7}$  to  $10^{-1}$   $\mu$ Ci/cc)

## ENVIRONMENTAL CHARACTERISTICS

- Normal temperature: +5 °C to +40 °C (+41 °F to +104 °F)
- Temperature limit:
  - Processing unit: -5 °C to +55 °C (+23 °F to +131 °F)
  - Detector: +0 °C to +60 °C (+32 °F to +140 °F)
- MTBF:
  - Processing unit: > 50 000 hours
  - Detector: > 40 years
- TID: 100 Gy ( $10^{+4}$  rad)
- Protection index: IP65 and IK07

## MECHANICAL CHARACTERISTICS

- Dimensions:
  - Processing unit: 390 mm x 196 mm x 187 mm (15.3 in x 7.7 in x 7.3 in)
  - Detector: 240 mm x 279 mm x 276 mm (9.4 in x 11.9 in x 10.8 in)
- Weight:
  - Processing unit: 4.5 kg or 7 kg (10 lb or 15.5 lb)
  - Detector: 11 kg (24.2 lb)
- Color: gray RAL 7030 (decontaminable paint)

## ELECTRICAL CHARACTERISTICS

- Power supply: 230 Vac – 50 Hz or 120 Vac – 60 Hz
- Data link outputs: one RS232 (LPDU only) and two isolated RS485
- Alarm relays: three SPDT relays
- I/O: two isolated analog outputs and one isolated analog input (0/4-20 mA)

## SIGNALING (APPLICABLE TO LPDU ONLY)

- Alphanumeric display: measurement, status...
- Sound alarm: buzzer 90 dBA at 1 meter
- Visual alarm: three lights (red, yellow, green)

## REFERENCE STANDARDS

- Environmental: IEC/IEEE 60780-323
- Seismic: IEEE 344 and IEC 60980
- EMC: 2014/30/EU and 2014/35/EU, EPRI 102323, RG 1.180, IEC 61000-6-2 and IEC 61000-6-4

## VERSIONS

- 230 Vac or 120 Vac
- Local processing and display unit (LPDU) or local processing unit (LPU)
- With or without RS485 junction box
- With or without check source
- With or without heater
- Detector cable length: from 20 m (66 ft) to 65 m (213 ft)
- Junction box cable length: 5 m (16.4 ft) or 10 m (32.8 ft)

## ACCESSORIES

- Calibration tools
- Software: MASS2™, RAMVISION™, SIMS2™ applications...
- Ethernet (LPDU version only)
- USB converters
- Seismic qualified wall mounting bracket for LP(D)U



**MIRION**  
TECHNOLOGIES

Copyright © 2024 Mirion Technologies, Inc. or its affiliates. All rights reserved. Mirion, the Mirion logo, and other trade names of Mirion products listed herein are registered trademarks or trademarks of Mirion Technologies, Inc. or its affiliates in the United States and other countries. Third party trademarks mentioned are the property of their respective owners.





RAMSYS™

# NIM 201K™

## Neutron Irradiation Dose Rate Monitor

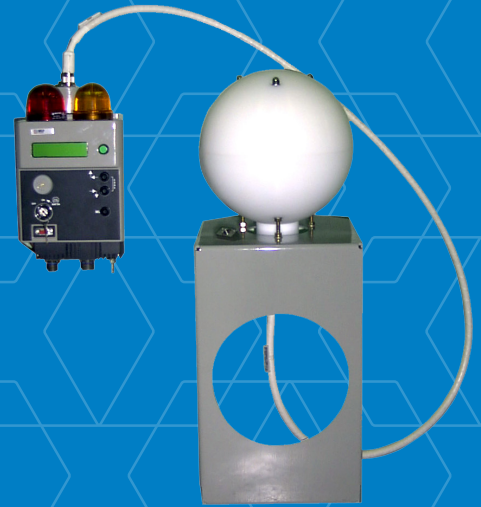

Monitoring neutron equivalent dose rate in real time.

### DESCRIPTION

The NIM 201K monitor forms part of the RAMSYS product line. It has been developed to monitor the neutron equivalent dose rate in real time.

It provides operational dose rate in units of  $H^*(10)$  derived from neutron fluence according to ICRU 57 recommendations. The helium-3 proportional counter (cylindrical tube) placed inside a polyethylene sphere detects thermal and fast neutrons. Its large energy range, associated with modular design makes it efficient, reliable and very sensitive. It is used effectively in nuclear reactors, subcritical stacks, neutron generators, irradiators and in accelerator facilities.

### FEATURES

- ✓ Detector for indoor and outdoor applications
- ✓  $H^*(10)$  measurement
- ✓ Available with or without display and local signaling
- ✓ Wide and high neutron energy range ( $2.5 \cdot 10^{-8}$  to 16 MeV)
- ✓ Compact and reliable

# NIM 201K™ NEUTRON IRRADIATION DOSE RATE MONITOR

## PHYSICAL CHARACTERISTICS

- Radiation detected: neutron
- Detector: He3 proportional counter
- Energy range:  $2.5 \cdot 10^{-8}$  (thermal) to 16 MeV
- Typical measurement range (according to IEC61322):  $10^{-6}$  to 0.1 Sv/h ( $10^{-4}$  to 10 rem/h)
- Measurement capability:  $10^{-7}$  to 0.3 Sv/h ( $10^{-5}$  to 30 rem/h)

## ENVIRONMENTAL CHARACTERISTICS

- Normal temperature: +5 °C to +40 °C (+41 °F to +104 °F)
- Temperature limit:
  - Processing unit: -5 °C to +55 °C (+23 °F to +131 °F)
  - Detector: -20 °C to +70 °C (-4 °F to +158 °F)
- MTBF:
  - Processing unit: > 50 000 hours
- TID:
  - Processing unit: 100 Gy ( $10^{+4}$  rad)
  - Detector:  $5 \cdot 10^{+3}$  Gy ( $5 \cdot 10^{+5}$  rad)
- Protection index: IP65 and IK07

## MECHANICAL CHARACTERISTICS

- Dimensions:
  - Processing unit: 390 mm x 196 mm x 187 mm (15.3 in x 7.7 in x 7.3 in)
  - Detector sub-assembly: 817 mm x 312 mm x 310 mm (32.2 in x 12.3 in x 12.2 in)
- Weight:
  - Processing unit: 8.5 kg (18.7 lb)
  - Detector sub-assembly: ~ 31 kg (~ 68.3 lb)
- Color: gray RAL 7030 (decontaminable paint)

## ELECTRICAL CHARACTERISTICS

- Power supply: 230 Vac – 50 Hz or 120 Vac – 60 Hz
- Data link outputs: one RS232 (LPDU only) and two isolated RS485
- Alarm relays: three SPDT relays
- I/O: two isolated analog outputs and one isolated analog input (0/4-20 mA)

## SIGNALING (APPLICABLE TO LPDU ONLY)

- Alphanumeric display: measurement, status...
- Sound alarm: buzzer 90 dBA at 1 meter
- Visual alarm: three lights (red, yellow, green)

## REFERENCE STANDARDS

- Nuclear: IEC 61322, IEC 61005
- EMC: 2014/30/EU and 2014/35/EU, IEC 61000-6-2 and IEC 61000-6-4

## VERSIONS

- 230 Vac or 120 Vac
- Local processing and display unit (LPDU) or local processing unit (LPU)
- With or without RS485 junction box
- Detector cable length: 2 m (6.56 ft), 5 m (16.4 ft) or 10 m (32.8 ft)
- Junction box cable length: 2 m (5.65 ft), 5 m (16.4 ft) or 10 m (32.8 ft)

## ACCESSORIES

- Calibration source
- Software: MASS2™, RAMVISION™, SIMS2™ applications...
- USB converters



**MIRION**  
TECHNOLOGIES

Copyright © 2023 Mirion Technologies, Inc. or its affiliates. All rights reserved. Mirion, the Mirion logo, and other trade names of Mirion products listed here in are registered trademarks or trademarks of Mirion Technologies, Inc. or its affiliates in the United States and other countries. Third party trademarks mentioned are the property of their respective owners.



PROTK™ & RAMSYS™

# Detectors

## For Radiation Monitoring



### Detectors for nuclear measurement.

#### DESCRIPTION

Detectors for nuclear measurement have to transform the physical quantity "nuclear radiation" (e.g. particle flux or energy) into an electrical signal. Especially, charged particles generated by the interaction of radiation with matter are used for that purpose.

The detector program of Mirion Technologies (MGPI H&B) GmbH offers ionization chambers, scintillation counters, silicon detectors and GM counters, the majority of them are type tested.

#### FEATURES

- ✓ Gamma ionization chambers for dose rate monitoring
- ✓ Beta ionization chambers for noble gas monitoring
- ✓ Gamma and beta scintillation detectors for activity monitoring
- ✓ Large-area silicon detectors for alpha and beta monitoring
- ✓ GM-detectors for simple applications
- ✓ BF<sub>3</sub> proportional counter tubes for sensitive neutron monitoring
- ✓ Neutron ionization chambers for out-core monitoring

# DETECTORS FOR RADIATION MONITORING

## TYPE CODE

For detectors manufactured by Mirion Technologies (MGPI H&B) GmbH, Munich

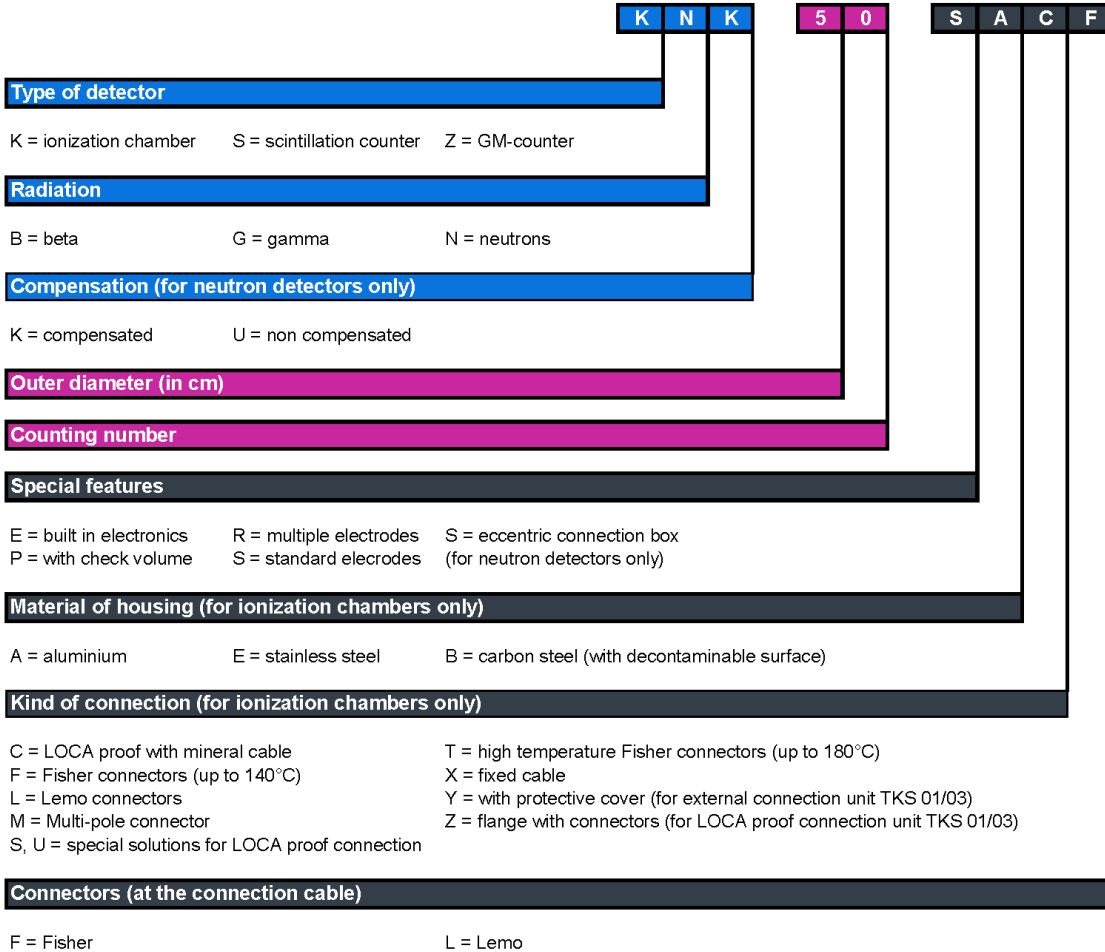

**MIRION**  
TECHNOLOGIES

Copyright © 2024 Mirion Technologies, Inc. or its affiliates. All rights reserved. Mirion, the Mirion logo, and other trade names of Mirion products listed herein are registered trademarks or trademarks of Mirion Technologies, Inc. or its affiliates in the United States and other countries. Third party trademarks mentioned are the property of their respective owners.



PROTK™

# KB 100 PEF/SEF™

## Beta Ionization Chambers



### Ionization chambers for high range beta activity monitoring

#### DESCRIPTION

The ionization chambers series KB 100 have been developed for high range beta activity monitoring, e.g. noble gas monitoring. The version KB 100 PEF has a check volume integrated in the detector housing which enables remote testing without access to the location of the detector.

Ionizing radiation produces charged particles in the gas filling of the ionization chamber. The transportation of these charged particles in the electrical field and their discharge on the electrodes causes charge pulses. The charge pulses are integrated to a DC current, which can be measured in the external circuit.

#### FEATURES

- ✓ Wide measuring range
- ✓ Beta energy range: 70 keV to 3 MeV
- ✓ Output signal: DC current starting at 0.1 pA
- ✓ Saturation proof
- ✓ Rugged construction
- ✓ Version KB 100 PEF with integrated check volume for remote testing

# KB 100 PEF/SEF™ BETA IONIZATION CHAMBERS

## TECHNICAL CHARACTERISTICS

Properties	KB 100 PEF	KB 100 SEF
<b>Beta-sensitivity</b> Kr-85 Xe-133	5.6e-21 A/(Bq/m <sup>3</sup> ) 1.7e-21 A/(Bq/m <sup>3</sup> )	5.6e-21 A/(Bq/m <sup>3</sup> ) 1.7e-21 A/(Bq/m <sup>3</sup> )
<b>Measuring range</b> Kr-85 Xe-133	2e7 ... 5e13 Bq/m <sup>3</sup> 1e8 ... 1.5e14 Bq/m <sup>3</sup>	1e8 ... 3e16 Bq/m <sup>3</sup> 70 keV ... 3 MeV
<b>Beta energy range</b>	70 keV ... 3 MeV	
<b>Gamma sensitivity</b> <b>Gamma energy range</b> <i>(in the main direction through the window)</i>	1.2e-11 A/(mGy/h) 30 keV ... 3 MeV	1.2e-11 A/(mGy/h) 30 keV ... 3 MeV
<b>Gas filling</b> <b>Detector housing</b> <b>Detector window</b> <b>Check source</b>	Argon, 5.5 bar Stainless steel 1.4571 Titanium, 15 µm Strontium-90, 37 MBq	Argon, 5.5 bar Stainless steel 1.4571 Titanium, 15 µm -
<b>Operating voltage</b> <b>Check current from check volume</b>	800V 1e-9 A approx.	800V -
<b>Temperature range</b> <b>Ambient pressure</b> <b>Dimensions Ø (flange) x L</b> <b>Weight (without connector)</b>	0 ... 135°C (32 ... 275°F) 0 ... 5 bar 115 (139) × 220 mm (6.1 (5.4) x 8.6 in) 6.5 kg approx. (14.3 lb)	0 ... 80°C (32 ... 176°F) 0 ... 5 bar 115 (139) × 114 mm (6.1 (5.4) x 4.5 in) 4.6 kg approx. (10.1 lb)

Beta-sensitivity and measuring range are in combination with measuring vessel RSD 211.

### BETA IONIZATION CHAMBER WITH CHECK VOLUME

The KB 100 PEF ionization chamber has a second electrode system within the pressurized housing. The second system is irradiated by a built-in beta source, which generates a continuous detector current for test purposes.

This test current can be added to the current of the measuring system by an external switch unit, which is part of the NV 102 P c/f-converter.

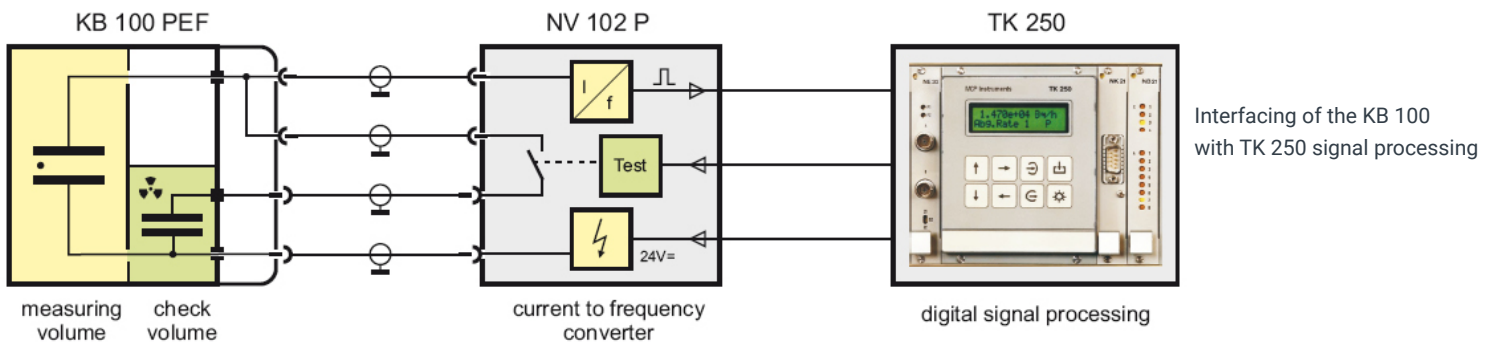

Interfacing of the KB 100 with TK 250 signal processing



Copyright © 2024 Mirion Technologies, Inc. or its affiliates. All rights reserved. Mirion, the Mirion logo, and other trade names of Mirion products listed herein are registered trademarks or trademarks of Mirion Technologies, Inc. or its affiliates in the United States and other countries. Third party trademarks mentioned are the property of their respective owners.



PROTK™ & RAMSYS™

# KG Series™

## Gamma Ionization Chambers



**Ionization chambers for gamma dose rate monitoring in nuclear facilities.**

### DESCRIPTION

Gamma radiation produces charged particles in the gas filling of an ionization chamber. Transportation of these particles in the electrical field between the electrodes generates a DC current, which can be measured in the external circuit.

The sensitivity of an ionization chamber is proportional to the gas quantity inside, and therefore to the specific mass of the gas and to the volume of the detector. But, the sensitivity is independent of temperature and environmental pressure.

### FEATURES

- ✓ Large measuring range
- ✓ Saturation proof
- ✓ Energy range: 60 or 80 keV to 3 MeV
- ✓ Output signal: DC current starting at 0.1 pA
- ✓ Long life time
- ✓ Versions KG ... P with check volume for remote testing
- ✓ Version KG 50 SEC for post accident conditions

# KG SERIES™ GAMMA IONIZATION CHAMBERS

## PREFERRED TYPES

Typ	Sensitivity A/(Sv/h)	Measuring Range (Sv/h)	Operating Temperature		Remarks
			Continuous	1h max.	
KG 50 SEC	1.1e-9	1e-3 ... 1e+5	0 ... 135 °C (32 ... 275 °F)	205 °C (401 °F)/3 h	60 keV to 7 MeV
KG 80 PED	1e-8	1e-5 ... 1e+5	-25 ... 180 °C (-13 ... 356 °F)	190 °C (374 °F)	1 bar; C
KG 80 PEF	1e-8	1e-5 ... 1e+5	-25 ... 100 °C (-13 ... 212 °F)	120 °C (248 °F)	6 bar; T, C
KG 80 SAC	1e-9	1e-4 ... 1e+5	0 ... 150 °C (32 ... 302 °F)	180 °C (356 °F)	60 keV up; T
KG 82 SEZ	1e-9	1e-4 ... 1e+5	0 ... 120 °C (32 ... 248 °F)	160 °C (320 °F)	TT
KG 83 SEZ	6e-11	1e-2 ... 1e+6	0 ... 120 °C (32 ... 248 °F)	160 °C (320 °F)	
KG 122 SBL	1e-6	1e-7 ... 1	0 ... 80 °C (32 ... 176 °F)	120 °C (248 °F)	E
KG 122 PEF	1e-6	1e-6 ... 1	0 ... 100 °C (32 ... 212 °F)		T, C
KG 151 RBF	2e-6	1e-7 ... 100	0 ... 150 °C (32 ... 302 °F)	180 °C (356 °F)	T
KG 151 REZ	2e-6	1e-7 ... 100	-25 ... 150 °C (-13 ... 302 °F)	180 °C (356 °F)	T
KG 220 SEF	1e-6	1e-7 ... 100	-30 ... 100 °C (-22 ... 212 °F)	120 °C (248 °F)	T
KG 220 SEU	1e-6	1e-7 ... 100	-30 ... 120 °C (-22 ... 248 °F)		T
KG 220 EEM	1e-6 Hz/Sv/h	1e-7 ... 0.3	0 ... 80 °C (32 ... 176 °F)		165 °C (329 °F)

E = Op. experience  
 T = type tested  
 C = with check volume

## COMMON DATA

- Energy range: 80 keV to 3 MeV
- Detector voltage: 800 ... 1400 V, depending on version and range

## MEASURING RANGE AND OUTPUT SIGNALS

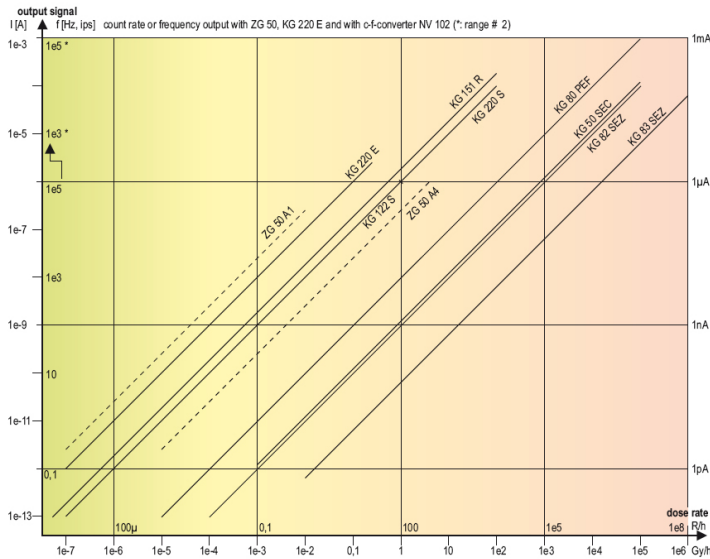

Copyright © 2024 Mirion Technologies, Inc. or its affiliates. All rights reserved. Mirion, the Mirion logo, and other trade names of Mirion products listed herein are registered trademarks or trademarks of Mirion Technologies, Inc. or its affiliates in the United States and other countries. Third party trademarks mentioned are the property of their respective owners.





PROTK™ & RAMSYS™

# KG 50/51 SEC™

## Gamma Ionization Chambers



**High range gamma dose rate monitoring under accident and post accident conditions.**

### DESCRIPTION

The KG 50/51 SEC ionization chambers have been developed for high range gamma dose rate monitoring under accident and post accident conditions. Gamma radiation produces charged particles in the gas filling of the ionization chamber. The transportation of these charged particles in the electrical field and their discharge on the electrodes causes charge pulses. The charge pulses are integrated to a DC current, which can be measured in the external circuit.

The KG 50/51 SEC ionization chambers may be connected to signal processing units, both, of the RAMSYS or proTK family.

### FEATURES

- ✓ Large measuring range up to 100 kGy/h
- ✓ Saturation proof
- ✓ Rugged construction
- ✓ Long life time
- ✓ Energy range: 60 keV to 7 MeV
- ✓ Output signal: DC current starting at 1 pA
- ✓ Up to 70 m (230 ft) of metal shielded cable, extension cable available
- ✓ Ambient conditions up to 205 °C (401 °F), 7 bar
- ✓ LOCA qualified

# KG 50/51 SEC™ GAMMA IONIZATION CHAMBERS

## TECHNICAL CHARACTERISTICS

Properties	KG 50 SEC	KG 51 SEC	Acceptable Tolerance
<b>Measuring range</b>	1e-3 Gy/h ... 1e+3 Gy/h 1e+3 Gy/h ... 1e+5 Gy/h	1e-5 Gy/h ... 1e+1 Gy/h 1e+1 Gy/h ... 1e+3 Gy/h	± 20% of sensitivity ± 40% of sensitivity
<b>Sensitivity for Cs-137 for Xe-133</b>	1.0e-9 A/(Gy/h) 1.2e-9 A/(Gy/h)	2.0e-8 A/(Gy/h) 2.4e-8 A/(Gy/h)	± 15% at 1 Gy/h ± 15% at 1 Gy/h
<b>Energy range</b>	100 keV ... 3 MeV 60 keV ... 7 MeV	100 keV ... 3 MeV 60 keV ... 7 MeV	± 20% of sensitivity ± 50% of sensitivity
<b>Detector housing Gas filling Electrodes Radioactive embedded source</b>	Stainless steel Nitrogen/Argon, 1 bar Aluminium Am-241, 1 kBq	Stainless steel Nitrogen/Argon, 20 bar Aluminium -	
<b>Operating voltage Basic current from embedded source</b>	800 V 1e-12 A approx.	800 V -	
<b>Temperature range Short term temperature range Ambient pressure Protection index Dimensions (Ø × L, without cable) Weight (without cable and connector) Weight (with 60 m cables and connectors)</b>	0 ... 135 °C (32 ... 275 °F) 205 °C (401 °F) for 3h 0 ... 7 bar IK07 and IP67 50.8 mm × 440 mm (1.9 in × 17.3 in) 2.1 kg (4.6 lb) 12.8 kg (28.2 lb)	0 ... 135 °C (32 ... 275 °F) 205 °C (401 °F) for 3h 0 ... 7 bar IK07 and IP67 50.8 mm × 440 mm (1.9 in × 17.3 in) 2.1 kg (4.6 lb) 12.8 kg (28.2 lb)	
<b>Cables Cable length Connectors</b>	Metal shielded cable, ceramic insulation 0.3 to 70 m on request (1 to 229 ft) Radiall HN, others on request		

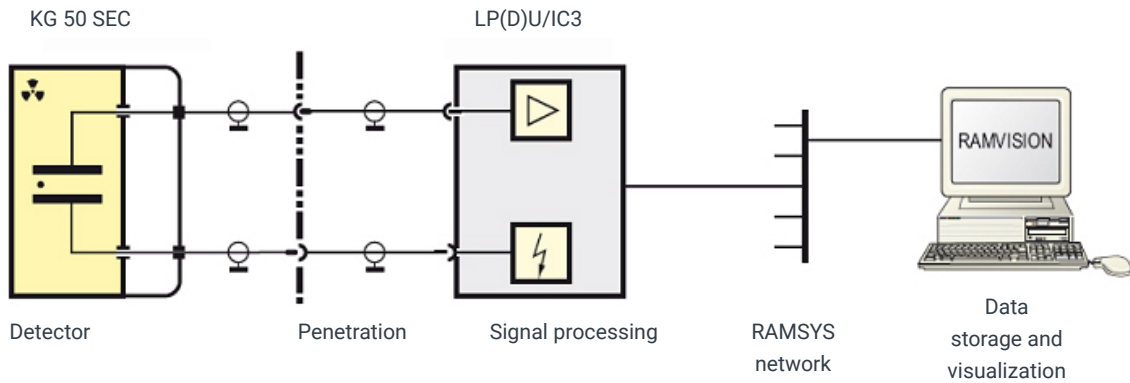

Copyright © 2024 Mirion Technologies, Inc. or its affiliates. All rights reserved. Mirion, the Mirion logo, and other trade names of Mirion products listed herein are registered trademarks or trademarks of Mirion Technologies, Inc. or its affiliates in the United States and other countries. Third party trademarks mentioned are the property of their respective owners.



PROTK™ & RAMSYS™

# KG 80 PED/PEF™

## Gamma Ionization Chambers



**Gamma dose rate monitoring under extreme conditions.**

### DESCRIPTION

The ionization chambers series KG 80 PED/PEF have been developed for gamma dose rate monitoring under extreme conditions. There is a check volume integrated in the detector housing which enables remote testing without access to the location of the detector.

Gamma radiation produces charged particles in the gas filling of the ionization chamber. The transportation of these charged particles in the electrical field and their discharge on the electrodes causes charge pulses. The charge pulses are integrated to a DC current, which can be measured in the external circuit.

### FEATURES

- ✓ Ionization chamber with check volume for functional check at non accessible locations
- ✓ Wide dynamic range up to 100 kGy/h
- ✓ Energy range: 80 keV to 3 MeV
- ✓ Output signal: DC current starting at 1 pA
- ✓ Operates up to 180 °C (356 °F) and 7 bar
- ✓ Robust and reliable

# KG 80 PED/PEF™ GAMMA IONIZATION CHAMBERS

## TECHNICAL CHARACTERISTICS

Properties	KG 80 PED	KG 80 PEF	Acceptable Tolerance
Measuring range	1e-5 Gy/h ... 1e+3 Gy/h 1e+3 Gy/h ... 1e+5 Gy/h		± 20%; 800V acceptable deviation of sensitivity ± 40%; 1200V acceptable deviation of sensitivity
Sensitivity Energy range	1.0e-8 A/(Gy/h) 80 keV ... 3 MeV		± 15% ± 20% acceptable deviation of sensitivity
Detector housing Gas filling Check source in the sensitive volume Check source in the check volume	Stainless steel 1.4571 Argon, 6 bar Sr-90, 3.7 MBq Sr-90, 37 MBq		
Operating voltage Basic current in the sensitive volume Basic current in the check volume	800 ... 1200V Approx. 2 ... 5e-13 A Approx. 1.2e-9 A		
Temperature range Short term temperature range, for max 1 h Environmental pressure Dimensions (Ø × L, without cable) Weight (without cable)	-25 ... 180°C (-13 ... 356°F) 190°C (374°F) 0.7 ... 7 bar 120 mm × 500 mm (4.7 in x 19.6 in) 6.3 kg (13.8 lb)	-25 ... 100°C (-13 ... 212°F) 120°C (248°F) 0.7 ... 7 bar 120 mm × 500 mm (4.7 in x 19.6 in) 6.5 kg (14.3 lb)	
Cable Connectors (KG 80 PEF only)	Coaxial cable (e.g. Raychem 5031B; the maximum length (capacity) of cable is determined by signal processing)	Coaxial cable (e.g. Raychem 5031B; the maximum length (capacity) of cable is determined by signal processing) Fischer size 105	

## GAMMA IONIZATION CHAMBER WITH CHECK VOLUME

The KG 80 ionization chambers have a second electrode system within the pressurized housing. The second system is irradiated by a built-in beta source, which generates a continuous detector current for test purposes. This test current can be added to the current of the measuring system by an external switch unit, which is part of the NV 102 P c/f-converter.

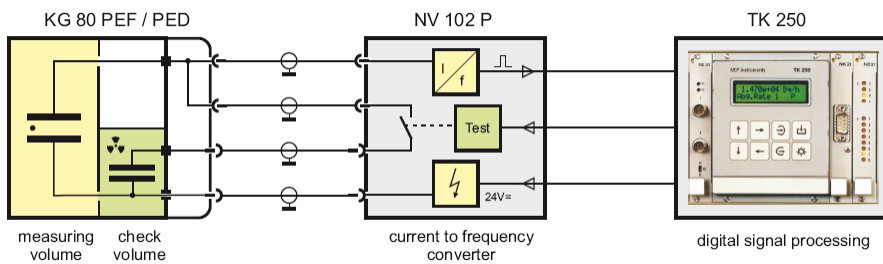

Interfacing of the KG 80 with TK 250 signal processing



Copyright © 2024 Mirion Technologies, Inc. or its affiliates. All rights reserved. Mirion, the Mirion logo, and other trade names of Mirion products listed herein are registered trademarks or trademarks of Mirion Technologies, Inc. or its affiliates in the United States and other countries. Third party trademarks mentioned are the property of their respective owners.



PROTK™ & RAMSYS™

# KG 151 RBT/REZ™

## Gamma Ionization Chambers



**Low and medium range gamma dose rate monitoring in nuclear facilities.**

### DESCRIPTION

The KG 151 RBT/REZ ionization chambers have been developed for low and medium range gamma dose rate monitoring in nuclear facilities.

Gamma radiation produces charged particles (electrons and gas ions) in the gas filling the ionization chamber. Their discharge on the electrodes causes charge pulses. These charge pulses are integrated to a DC current, which can be measured in the external circuit. The KG 151 RBT/REZ ionization chambers may be connected to signal processing units of the RAMSYS or proTK family.

### FEATURES

- ✓ Wide measuring range up to 100 Gy/h
- ✓ Saturation proof
- ✓ Robust construction
- ✓ Long life time
- ✓ Energy range: 80 keV to 3 MeV
- ✓ Output signal: DC current starting at 0.1 pA
- ✓ Ambient temperature up to 180 °C (356 °F)

## KG 151 RBT/REZ™ GAMMA IONIZATION CHAMBERS

### TECHNICAL CHARACTERISTICS

Properties	KG 151 RBT	KG 151 REZ	Acceptable Tolerance
<b>Measuring range</b>	1e-7 Gy/h ... 1 Gy/h 1 Gy/h ... 1e+2 Gy/h	1e-7 Gy/h ... 1 Gy/h 1 Gy/h ... 1e+2 Gy/h	± 20% acceptable deviation of sensitivity ± 40% acceptable deviation of sensitivity
<b>Sensitivity</b> <b>Energy range</b>	2e-6 A/(Gy/h) 80 keV ... 3 MeV	2.23e-6 A/(Gy/h) 80 keV ... 3 MeV	± 10% ± 40% acceptable deviation of sensitivity (KTA 1501)
<b>Detector housing</b> <b>Gas filling</b> <b>Embedded source</b>	Steel Argon, 26 bar Cs-137, 185 kBq	Stainless steel Argon, 26 bar Cs-137, 185 kBq	
<b>Operating voltage</b> <b>Break down voltage</b> <b>Detector source current</b>	1200 VDC, typ. 2500 VDC 1e-12 A approx.		± 5% 10 s max. With embedded source
<b>Temperature range</b> <b>Short term temperature range</b> <b>External pressure</b> <b>Humidity</b>	0 ... 150°C (0 ... 302°F) < 180°C (356°F) 0.7 ... 1.3 bar < 95%	-25 ... 150°C (-13 ... 302°F) < 180°C (356°F) 0.7 ... 1.3 bar < 95%	
<b>Length of detector</b> <b>Total length</b> <b>Diameter</b> <b>Sensitive volume</b> <b>Weight (without connector and cable)</b>	502 mm (19.7 in) 595 mm (23.4 in) 150 mm (5.9 in) 5.7 l Approx. 12.5 kg (27.5 lb)	502 mm (19.7 in) 602 mm (23.7 in) 150 mm (5.9 in) 5.7 l Approx. 14 kg (30.8 lb)	
<b>Connectors</b>	Fischer size 105		Max. cable length is depending on signal processing unit (cable capacity)

### ACCESSORIES

- Assembly kit with insulated clamps
- TKS 01: cable protection unit for LOCA-proof installation of KG 151 REZ
- TKA 66.11: calibration source Cs-137, remote operated
- Connection cables: low noise cable, e.g. Raychem 5021B or Gore GCX 0157
- Digital signal processing units:
  - proTK system: e.g. DPK 251 digital signal processing channel with c/f-converter NV 103
  - RAMSYS system: LPU IC3 or LPDU IC3 local signal processing units



**MIRION**  
TECHNOLOGIES

Copyright © 2024 Mirion Technologies, Inc. or its affiliates. All rights reserved. Mirion, the Mirion logo, and other trade names of Mirion products listed herein are registered trademarks or trademarks of Mirion Technologies, Inc. or its affiliates in the United States and other countries. Third party trademarks mentioned are the property of their respective owners.



PROTK™ & RAMSYS™

# KG 220 SEF™

## Gamma Ionization Chamber



**Low and medium range gamma dose rate monitoring in nuclear facilities.**

### DESCRIPTION

The KG 220 SEF ionization chamber has been developed for low and medium range gamma dose rate monitoring in nuclear facilities. There are two versions with optimized energy response for measuring dose rates in Sievert or Gray units. Gamma radiation produces charged particles (electrons and gas ions) in the gas filling of the ionization chamber. Their discharge on the electrodes causes charge pulses. These charge pulses are integrated to a DC current, which can be measured in the external circuit.

The KG 220 ionization chambers may be connected to signal processing units of the RAMSYS or proTK family.

### FEATURES

- ✓ Wide measuring range up to 100 Gy/h or Sv/h
- ✓ Saturation proof
- ✓ Robust construction
- ✓ Long life time
- ✓ Energy range: 80 keV to 7 MeV
- ✓ Output signal: DC current starting at 0.1 pA
- ✓ Ambient temperature up to 120 °C (248 °F)

# KG 220 SEF™ GAMMA IONIZATION CHAMBER

## TECHNICAL CHARACTERISTICS

Properties	KG 220 SEF-Gy	KG 220 SEF-Sv	Acceptable Tolerance
<b>Measuring range</b>	1e-7 Gy/h ... 1 Gy/h 1 Gy/h ... 1e+2 Gy/h	1e-7 Sv/h ... 1 Sv/h 1 Sv/h ... 1e+2 Sv/h	+5%/-20% acceptable deviation of sensitivity +5%/-40% acceptable deviation of sensitivity
<b>Sensitivity</b>	1.1e-6 A/(Gy/h)	0.9e-6 A/(Sv/h)	± 10% ± 25% acceptable deviation of sensitivity (IEC 60532)
<b>Energy range</b>	80 keV ... 3 MeV	80 keV ... 3 MeV	± 40% acceptable deviation of sensitivity (KTA 1501)
<b>Radiation direction (&gt; 100 keV)</b>	±90° to main axis	±90° to main axis	± 20% acceptable deviation of sensitivity
<b>Detector housing</b> <b>Gas filling</b> <b>Option: embedded source</b>	Stainless steel, 4 mm Argon, 32 bar Cs-137, 185 kBq		
<b>Operating voltage</b> <b>Break down voltage</b> <b>Detector background current</b> <b>Detector source current</b>	1400 VDC 2500 VDC 1e-13 A approx. 8e-13 A approx.		± 5% 10 s max. Ambient background With embedded source
<b>Temperature range</b> <b>Short term temperature range</b> <b>External pressure</b> <b>Humidity</b>	-30 ... +100 °C (-22 ... +212 °F) < 120 °C (248 °F) 0.7 ... 1.3 bar < 95%		1 h max.
<b>Protection index</b>	IP67 and IK07		
<b>Dimensions (Ø × L, without cables)</b> <b>Diameter of base plate</b> <b>Weight (without cable and connector)</b>	220 mm × 240 mm (8.7 in x 9.5 in) 280 mm (11 in) Approx. 23 kg (51 lb)		
<b>Connectors</b>	Fischer size 105		Max. cable length is depending on signal processing unit (cable capacity)

## ACCESSORIES

- TKA 16: calibration source Cs-137 with lead housing and fixture
- TKA 66: calibration source Cs-137 remote operated
- Connection cables: e.g. Raychem 5021B (low noise)
- Digital signal processing units:
  - TK 250 system: e.g. DPK 251 digital signal processing channel with c/f-converter NV 103
  - RAMSYS system: LPU IC3 or LPDU IC3 local signal processing units



Copyright © 2024 Mirion Technologies, Inc. or its affiliates. All rights reserved. Mirion, the Mirion logo, and other trade names of Mirion products listed herein are registered trademarks or trademarks of Mirion Technologies, Inc. or its affiliates in the United States and other countries. Third party trademarks mentioned are the property of their respective owners.





RAMSYS™

# ABPM 201S™

## Seismic Alpha Beta Particulate Monitor

Sampling of air extracted from ventilation ducts or stacks. Can withstand seismic conditions. Dynamic compensation of radon and thoron progenies.

### DESCRIPTION

The ABPM 201S monitor forms part of the RAMSYS product line.

It has been developed to sample air extracted from ventilation ducts or stacks. A double silicon detector performs the gamma compensation and a radial fin grid limits the scattering of the alpha particles (static compensation) which facilitates the compensation of the radon and thoron solid progenies by the processing algorithms (dynamic compensation). Operating costs are minimized by the autonomous operation through automatic filter advance management.



### FEATURES

- ✓ Static and dynamic compensation of the radon and thoron solid progenies
- ✓ Dynamic gamma background compensation
- ✓ Online spectrometry
- ✓ Up to 6 months filter cassette autonomy
- ✓ 1E qualification and embedded safety related software
- ✓ Available under 10 CFR 50 App. B, ASME NQA-1 and IEC 61226 programs for safety related application

# ABPM 201S™ SEISMIC ALPHA BETA PARTICULATE MONITOR

## PHYSICAL CHARACTERISTICS

- Radiation detected: alpha, beta and gamma
- Detector: dual large area silicon (PIPS® detector)
- Filter type: FSLW
- Typical energy windows:
  - Alpha: 2 MeV to 10 MeV
  - Beta: 80 keV to 2.5 MeV
  - Gamma: 80 keV to 2.5 MeV
- Typical measurement range:
  - Alpha:  $10^{-2}$  to  $3.7 \cdot 10^{+6}$  Bq/m<sup>3</sup> ( $2.7 \cdot 10^{-13}$  to  $10^{-4}$  µCi/cc)
  - Beta: 1 to  $3.7 \cdot 10^{+6}$  Bq/m<sup>3</sup> ( $2.7 \cdot 10^{-11}$  to  $10^{-4}$  µCi/cc)

## ENVIRONMENTAL CHARACTERISTICS

- Normal temperature: +5 °C to +40 °C (+41 °F to +104 °F)
- Temperature limit: -5 °C to +55 °C (+23 °F to +131 °F)
- MTBF: > 20 000 hours, with preventive maintenance
- TID: 100 Gy ( $10^{+4}$  rad)

## PNEUMATIC CHARACTERISTICS

- Standard flow rate: 35 l/min (1.24 scfm)
- Pressure drop: 100 to 350 mbar (1.45 to 5.07 psi)

## MECHANICAL CHARACTERISTICS

- Dimensions: 1305 mm x 830 mm x 680 mm (51.4 in x 32.7 in x 26.8 in)
- Weight: ~ 250 kg (~ 551 lb)
- Color: gray RAL 7030 (decontaminable paint)
- Inlet tube connection: Ø 25.4 mm OD (1 in)
- Outlet tube connection: Ø 12 mm OD (1/2 in)

## ELECTRICAL CHARACTERISTICS

- Power supply: refer to possible versions
- Data link outputs: one RS232 and two isolated RS485
- Alarm relays: three SPDT relays
- I/O: two isolated analog outputs and one isolated analog input (0/4-20 mA)

## SIGNALING

- Alphanumeric display: measurement, status...
- Sound alarm: buzzer 90 dBA at 1 meter
- Visual alarm: three lights (red, yellow, green)

## REFERENCE STANDARDS

- Nuclear: IEC 60761
- Environmental: IEC/IEEE 60780-323, RG 1.97
- Seismic: IEC 60980, IEEE 344
- EMC: 2014/30/EU and 2014/35/EU, EPRI 102323, MIL STD 461, IEC 61000-6-2 and IEC 61000-6-4

## VERSIONS

- 230 Vac or 230 Vac + 400 Vac 3Ø or 120 Vac + 400 Vac 3Ø
- Solenoid check sources
- With or without PIS sampler
- Gas grab sampler ports

## ACCESSORIES

- Calibration tools
- Software: MASS2™, RAMVISION™, SIMS2™ applications...
- USB converters



**MIRION**  
TECHNOLOGIES

Copyright © 2024 Mirion Technologies, Inc. or its affiliates. All rights reserved. Mirion, the Mirion logo, and other trade names of Mirion products listed herein are registered trademarks or trademarks of Mirion Technologies, Inc. or its affiliates in the United States and other countries. Third party trademarks mentioned are the property of their respective owners.



RAMSYS™

# ABPM 203M™

## Mobile Alpha Beta Particulate Monitor



Lightweight and movable to operate next to the respiratory tract of workers in workplace areas.

### DESCRIPTION

The ABPM 203M monitor forms part of the RAMSYS product line. Its small and lightweight extendable sensor allows this monitor to operate next to the respiratory tract of workers in their area. A dual silicon detector performs the gamma compensation, and a radial fin grid limits the scattering of the alpha particles (static compensation) which facilitates the compensation of the radon and thoron solid progenies by the processing algorithms (dynamic compensation).

Operating costs are minimized through unattended operation, by the use of a continuous filter and the online spectroscopy capability. The optional filter card can be used on the CE200 with a fixed filter in order to collect several radioactive particles. All these features make the ABPM 203M monitor an efficient diversified and cost-effective tool.

### FEATURES

- ✓ Static and dynamic compensation of the radon and thoron solid progenies
- ✓ Dynamic gamma background compensation
- ✓ Perfectly adapted for alpha and beta measurement of particulates in environment with high rate of radon
- ✓ Optimized alpha measurement for high energies ( $^{238}\text{PU}$ ,  $^{239}\text{PU}$ )
- ✓ Real-time alpha spectrometry
- ✓ Up to 6 months filter cassette autonomy with moving filter or fixed filter card option

# ABPM 203M™ MOBILE ALPHA BETA PARTICULATE MONITOR

## PHYSICAL CHARACTERISTICS

- Radiation detected: alpha, beta and gamma
- Detector: dual large area silicon (PIPS®)
- Filter type: FSLW
- Typical energy windows:
  - Alpha: 2 MeV to 10 MeV
  - Beta: 80 keV to 2.5 MeV
  - Gamma: 80 keV to 2.5 MeV
- Typical measurement range:
  - Alpha:  $10^{-2}$  to  $3.7 \cdot 10^{+6}$  Bq/m<sup>3</sup> ( $2.7 \cdot 10^{-13}$  to  $10^{-4}$  µCi/cc)
  - Beta: 1 to  $3.7 \cdot 10^{+6}$  Bq/m<sup>3</sup> ( $2.7 \cdot 10^{-11}$  to  $10^{-4}$  µCi/cc)

## ENVIRONMENTAL CHARACTERISTICS

- Normal temperature: +5 °C to +40 °C (+41 °F to +104 °F)
- Temperature limit: -5 °C to +55 °C (+23 °F to +131 °F)
- MTBF: > 20 000 hours, with preventive maintenance
- TID: 100 Gy ( $10^{+4}$  rad)

## PNEUMATIC CHARACTERISTICS

- Standard flow rate: 35 l/min (1.24 scfm)
- Pressure drop: 100 to 350 mbar (1.45 to 5.07 psi)

## MECHANICAL CHARACTERISTICS

- Dimensions: 1270 mm x 360 mm x 303 mm  
(50 in x 14.2 in x 12 in)
- Weight: ~ 26 kg (~ 57 lb)
- Color: gray RAL 7030 (decontaminable paint)

## ELECTRICAL CHARACTERISTICS

- Power supply: 230 Vac – 50 Hz or 120 Vac – 60 Hz
- Data link outputs: one RS232 and two isolated RS485
- Alarm relays: three SPDT relays
- I/O: two isolated analog outputs (0/4-20 mA)

## SIGNALING

- Alphanumeric display: measurement, status...
- Sound alarm: buzzer 90 dBA at 1 meter
- Visual alarm: three lights (red, yellow, green)

## REFERENCE STANDARDS

- Nuclear: IEC 60761
- EMC: 2014/30/EU and 2014/35/EU, IEC 61000-6-2 and IEC 61000-6-4

## VERSIONS

- 230 Vac or 120 Vac
- Detection sub-assembly available with or without shielding
- Hose length: 1.5 m (5 ft), 3 m (10 ft), 10 m (33 ft) or 20 m (66 ft)
- Moving filter or optional fixed filter

## ACCESSORIES

- Calibration tools
- Software: MASS2™, RAMVISION™, SIMS2™ applications...
- USB converters
- Radiomodem (either customer specified or WRM2™)
- Fixed filter holder kit

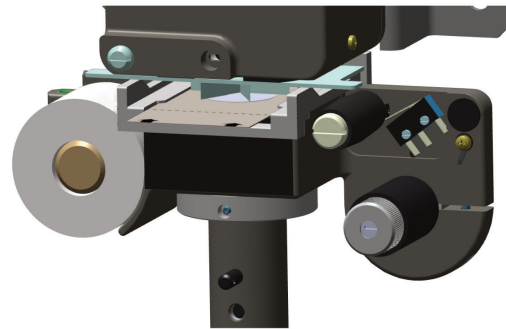

Fixed filter card option



**MIRION**  
TECHNOLOGIES

Copyright © 2023 Mirion Technologies, Inc. or its affiliates. All rights reserved. Mirion, the Mirion logo, and other trade names of Mirion products listed herein are registered trademarks or trademarks of Mirion Technologies, Inc. or its affiliates in the United States and other countries. Third party trademarks mentioned are the property of their respective owners.



RAMSYS™

# ABPM 204M™

## Mobile Alpha Beta Particulate Monitor



Small and lightweight extendable sensor to function locally next to the respiratory tract of workers.

### DESCRIPTION

The ABPM 204M monitor forms part of the RAMSYS product line. Its small and lightweight extendable sensor allows this monitor to operate next to the respiratory tract of workers in their area. A dual silicon detector performs the gamma compensation. A processing algorithm provides a dynamic compensation of radon and thoron solid progenies.

Operating costs are minimized through unattended operation, by the use of a continuous filter and the on-line spectroscopy capability. All these features make the ABPM 204M an efficient diversified and cost effective tool.

### FEATURES

- ✓ Dynamic compensation of the radon and thoron solid progenies
- ✓ Dynamic gamma background compensation
- ✓ Optimized beta measurement for environments with low rate of radon
- ✓ On-line alpha spectrometry
- ✓ Up to 6 months filter cassette autonomy
- ✓ Optimized alpha measurement for low energies ( $^{233}\text{U}$ ,  $^{235}\text{U}$ ,  $^{238}\text{U}$ )

# ABPM 204M™ MOBILE ALPHA BETA PARTICULATE MONITOR

## PHYSICAL CHARACTERISTICS

- Radiation detected: alpha, beta and gamma
- Detector: dual large area silicon (PIPS®)
- Filter type: FSLW
- Typical energy windows:
  - Alpha: 2 MeV to 10 MeV
  - Beta: 80 keV to 2.5 MeV
  - Gamma: 80 keV to 2.5 MeV
- Typical measurement range:
  - Alpha:  $10^{-2}$  to  $3.7 \cdot 10^{+6}$  Bq/m<sup>3</sup> ( $2.7 \cdot 10^{-13}$  to  $10^{-4}$  μCi/cc)
  - Beta: 1 to  $3.7 \cdot 10^{+6}$  Bq/m<sup>3</sup> ( $2.7 \cdot 10^{-11}$  to  $10^{-4}$  μCi/cc)

## ENVIRONMENTAL CHARACTERISTICS

- Normal temperature: +5 °C to +40 °C (+41 °F to +104 °F)
- Temperature limit: -5 °C to +55 °C (+23 °F to +131 °F)
- MTBF: > 20 000 hours, with preventive maintenance
- TID: 100 Gy ( $10^{+4}$  rad)

## PNEUMATIC CHARACTERISTICS

- Standard flow rate: 35 l/min (1.24 scfm)
- Pressure drop: 100 to 350 mbar (1.45 to 5.07 psi)

## MECHANICAL CHARACTERISTICS

- Dimensions: 1270 mm x 360 mm x 303 mm  
(50 in x 14.2 in x 12 in)
- Weight: ~ 26 kg (~ 57 lb)
- Color: gray RAL 7030 (decontaminable paint)

## ELECTRICAL CHARACTERISTICS

- Power supply: 230 Vac – 50 Hz or 120 Vac – 60 Hz
- Data link outputs: one RS232 and two isolated RS485
- Alarm relays: three SPDT relays
- I/O: two isolated analog outputs (0/4-20 mA)

## SIGNALING

- Alphanumeric display: measurement, status...
- Sound alarm: buzzer 90 dBA at 1 meter
- Visual alarm: three lights (red, yellow, green)

## REFERENCE STANDARDS

- Nuclear: IEC 60761
- EMC: 2014/30/EU and 2014/35/EU, IEC 61000-6-2 and IEC 61000-6-4

## VERSIONS

- 230 Vac or 120 Vac
- Hose length: 1.5 m (5 ft), 3 m (10 ft), 10 m (33 ft) or 20 m (66 ft)

## ACCESSORIES

- Calibration tools
- Software: MASS2™, RAMVISION™, SIMS2™ applications...
- USB converters
- Radiomodem (either customer specified or WRM2™)



**MIRION**  
TECHNOLOGIES

Copyright © 2024 Mirion Technologies, Inc. or its affiliates. All rights reserved. Mirion, the Mirion logo, and other trade names of Mirion products listed herein are registered trademarks or trademarks of Mirion Technologies, Inc. or its affiliates in the United States and other countries. Third party trademarks mentioned are the property of their respective owners.



RAMSYS™

# ABPM 205L™

## Alpha Beta Particulate Monitor



Sampling of air extracted from ventilation ducts or stacks.

### DESCRIPTION

The ABPM 205L monitor forms part of the RAMSYS product line.

It has been developed to sample air extracted from ventilation ducts or stacks. A double silicon detector is associated with a radial fin grid that limits the scattering of the alpha particles. The compensation of the radon and thoron solid progenies is then processed by specific algorithms.

Operating costs are minimized by the autonomous operation through automatic advanced filter management.

### FEATURES

- ✓ Static and dynamic compensation of the radon and thoron solid progenies
- ✓ Dynamic gamma background compensation
- ✓ Natural and artificial alpha volumetric activity indication
- ✓ On-line spectrometry
- ✓ Up to 6 months filter cassette autonomy

# ABPM 205L™ ALPHA BETA PARTICULATE MONITOR

## PHYSICAL CHARACTERISTICS

- Radiation detected: alpha, beta and gamma
- Detector: dual large area silicon (PIPS® detector)
- Filter type: FSLW
- Typical energy windows:
  - Alpha: 2 MeV to 10 MeV
  - Beta: 80 keV to 2.5 MeV
  - Gamma: 80 keV to 2.5 MeV
- Typical measurement range:
  - Alpha:  $10^{-2}$  to  $3.7 \cdot 10^{+6}$  Bq/m<sup>3</sup> ( $2.7 \cdot 10^{-13}$  to  $10^{-4}$  µCi/cc)
  - Beta: 1 to  $3.7 \cdot 10^{+6}$  Bq/m<sup>3</sup> ( $2.7 \cdot 10^{-11}$  to  $10^{-4}$  µCi/cc)

## ENVIRONMENTAL CHARACTERISTICS

- Normal temperature: +5 °C to +40 °C (+41 °F to +104 °F)
- Temperature limit: -5 °C to +55 °C (+23 °F to +131 °F)
- MTBF: > 20 000 hours, with preventive maintenance

## PNEUMATIC CHARACTERISTICS

- Standard flow rate: 35 l/min (1.24 scfm)
- Pressure drop: 100 to 350 mbar (1.45 to 5.07 psi)

## MECHANICAL CHARACTERISTICS

- Dimensions: 862 mm x 597 mm x 360 mm (33.9 in x 23.5 in x 14.2 in)
- Weight: ~ 45 kg (~ 99 lb)
- Color: gray RAL 7030 (decontaminable paint)
- Inlet tube connection: Ø 25.4 mm OD (1 in)
- Outlet tube connection: Ø 12 mm OD (1/2 in)

## ELECTRICAL CHARACTERISTICS

- Power supply: 230 Vac – 50 Hz or 120 Vac – 60 Hz
- Data link outputs: one RS232 and two isolated RS485
- Alarm relays: three SPDT relays
- I/O: two isolated analog outputs and one isolated analog input (0/4-20 mA)

## SIGNALING

- Alphanumeric display: measurement, status...
- Sound alarm: buzzer 90 dBA at 1 meter
- Visual alarm: three lights (red, yellow, green)

## REFERENCE STANDARDS

- Nuclear: IEC 60761
- EMC: 2014/30/EU and 2014/35/EU, IEC 61000-6-2 and IEC 61000-6-4

## VERSIONS

- 230 Vac or 120 Vac
- Local processing and display unit (LPDU) or local processing unit (LPU)
- Pumping unit
- Monitor wall fixing plate
- Ethernet

## ACCESSORIES

- Calibration tools
- Software: MASS2™, RAMVISION™, SIMS2™ applications...
- USB converters



**MIRION**  
TECHNOLOGIES

Copyright © 2023 Mirion Technologies, Inc. or its affiliates. All rights reserved. Mirion, the Mirion logo, and other trade names of Mirion products listed herein are registered trademarks or trademarks of Mirion Technologies, Inc. or its affiliates in the United States and other countries. Third party trademarks mentioned are the property of their respective owners.





RAMSYS™

# ABPM 205M™

## Mobile Alpha Beta Particulate Monitor

Sampling of air extracted from ventilation ducts or stacks.

### DESCRIPTION

The ABPM 205M monitor forms part of the RAMSYS product line.

It has been developed to sample air extracted from ventilation ducts or stacks. A double silicon detector is associated with a radial fin grid that limits the scattering of the alpha particles. The compensation of the radon and thoron solid progenies is then processed by specific algorithms.

Operating costs are minimized by the autonomous operation through automatic filter advance management.



### FEATURES

- ✓ Static and dynamic compensation of the radon and thoron solid progenies
- ✓ Dynamic gamma background compensation
- ✓ Natural and artificial alpha volumetric activity indication
- ✓ On-line spectrometry
- ✓ Up to 6 months filter cassette autonomy
- ✓ Can be used as temporary bypass for ABPM 205L or ABPM 201S when fixed unit is in maintenance with no loss of monitoring capability

# ABPM 205M™ MOBILE ALPHA BETA PARTICULATE MONITOR

## PHYSICAL CHARACTERISTICS

- Radiation detected: alpha, beta and gamma
- Detector: dual large area silicon (PIPS® detector)
- Filter type: FSLW
- Typical energy windows:
  - Alpha: 2 MeV to 10 MeV
  - Beta: 80 keV to 2.5 MeV
  - Gamma: 80 keV to 2.5 MeV
- Typical measurement range:
  - Alpha:  $10^{-2}$  to  $3.7 \cdot 10^{+6}$  Bq/m<sup>3</sup> ( $2.7 \cdot 10^{-13}$  to  $10^{-4}$  µCi/cc)
  - Beta: 1 to  $3.7 \cdot 10^{+6}$  Bq/m<sup>3</sup> ( $2.7 \cdot 10^{-11}$  to  $10^{-4}$  µCi/cc)

## ENVIRONMENTAL CHARACTERISTICS

- Normal temperature: +5 °C to +40 °C (+41 °F to +104 °F)
- Temperature limit: -5 °C to +55 °C (+23 °F to +131 °F)
- MTBF: > 20 000 hours, with preventive maintenance

## PNEUMATIC CHARACTERISTICS

- Standard flow rate: 35 l/min (1.24 scfm)
- Pressure drop: 100 to 350 mbar (1.45 to 5.07 psi)

## MECHANICAL CHARACTERISTICS

- Height: 1090 mm (42.9 in)
- Weight: ~ 38 kg (~ 84 lb)
- Color: gray RAL 7030 (decontaminable paint)
- Inlet tube connection: Ø 25.4 mm OD (1 in)
- Outlet tube connection: Ø 12 mm OD (1/2 in)

## ELECTRICAL CHARACTERISTICS

- Power supply: 230 Vac – 50 Hz or 120 Vac – 60 Hz
- Data link outputs: one RS232 and two isolated RS485
- Alarm relays: three SPDT relays
- I/O: two isolated analog outputs and one isolated analog input (0/4-20 mA)

## SIGNALING

- Alphanumeric display: measurement, status...
- Sound alarm: buzzer 90 dBA at 1 meter
- Visual alarm: three lights (red, yellow, green)

## REFERENCE STANDARDS

- Nuclear: IEC 60761
- EMC: 2014/30/EU and 2014/35/EU, IEC 61000-6-2 and IEC 61000-6-4

## VERSIONS

- 230 Vac or 120 Vac

## ACCESSORIES

- Calibration tools
- Software: MASS2™, RAMVISION™, SIMS2™ applications...
- USB converters
- Ethernet
- Outlet pipe: 3 m (9.8 ft) or 20 m (65 ft)
- Sampling pipe: 1 m (3.3 ft) or 20 m (65 ft)



**MIRION**  
TECHNOLOGIES

Copyright © 2024 Mirion Technologies, Inc. or its affiliates. All rights reserved. Mirion, the Mirion logo, and other trade names of Mirion products listed herein are registered trademarks or trademarks of Mirion Technologies, Inc. or its affiliates in the United States and other countries. Third party trademarks mentioned are the property of their respective owners.



RAMSYS™

# PM 205S™

## Beta Particulate Monitor



Continuously measuring the volumetric activity of a radioactive gaseous sample containing particulates.

### DESCRIPTION

The PM 205S monitor forms part of the RAMSYS product line. It has been developed to continuously measure the volumetric activity of a radioactive gaseous sample containing particulates. The sample is drawn from discharge stacks, reactor building, ventilation ducts or working areas via a pumping system. It is then admitted into a detection unit where the particulates are trapped on a filter. It is typically used for monitoring particulate volumetric activity under normal operating and mild environment conditions.

This monitor can operate as a stand alone device or in conjunction with an iodine monitor (IM 201), and/or noble gas monitors (NGM 203, NGM 204, NGM 214, NGM 216) to form a complete monitoring system.

### FEATURES

- ✓ 1E qualification and embedded safety related software
- ✓ Available under 10 CFR 50 App. B, ASME NQA-1 and IEC 61226 programs for safety related application

# PM 205S™ BETA PARTICULATE MONITOR

## PHYSICAL CHARACTERISTICS

- Radiation detected: beta
- Detector: 2" thin plastic scintillator + PMT + embedded LED (SB 70)
- Filter type: fiberglass 57 mm (2.24 in)
- Lead shield: 7.5 cm/4 π (3 in/4 π)
- Typical energy range: > 30 keV
- Typical measurement range: 3.7 10<sup>-2</sup> to 3.7 10<sup>+3</sup> Bq/m<sup>3</sup> (10<sup>-12</sup> to 10<sup>-7</sup> μCi/cc)

## ENVIRONMENTAL CHARACTERISTICS

- Normal temperature: +5 °C to +40 °C (+41 °F to +104 °F)
- Temperature limit:
  - Processing unit: -5 °C to +55 °C (+23 °F to +131 °F)
  - Detector: +0 °C to +60 °C (+32 °F to +140 °F)
- MTBF:
  - Processing unit: > 50 000 hours
  - Detector: > 40 years
- TID: 100 Gy (10<sup>+4</sup> rad)
- Protection index: IP65 and IK07

## PNEUMATIC CHARACTERISTICS

- Standard flow rate: 28.3 l/min (1 scfm)
- Pressure drop: 50 mbar (0.73 psi)

## MECHANICAL CHARACTERISTICS

- Dimensions: 889 mm x 1397 mm x 1651 mm (35 in x 55 in x 65 in)
- Weight: 700 kg (1543 lb)
- Color: gray RAL 7030 (decontaminable paint)
- Inlet tube connection: Ø 1 in
- Outlet tube connection: Ø 1/2 in

## ELECTRICAL CHARACTERISTICS

- Power supply: 230 Vac – 50 Hz or 120 Vac – 60 Hz
- Data link outputs: one RS232 (LPDU only) and two isolated RS485
- Alarm relays: three SPDT relays
- I/O: two isolated analog outputs and one isolated analog input (0/4-20 mA)

## SIGNALING (Applicable to LPDU only)

- Alphanumeric display: measurement, status...
- Sound alarm: buzzer 90 dBA at 1 meter
- Visual alarm: three lights (red, yellow, green)

## REFERENCE STANDARDS

- Nuclear: IEC 60761-1 and IEC 60761-2
- Environmental: IEC/IEEE 60780-323
- Seismic: IEC 60980, IEEE 344
- EMC: 2014/30/EU and 2014/35/EU, EPRI 102323, RG 1.180, IEC 61000-6-2 and IEC 61000-6-4

## VERSIONS

- 230 Vac or 120 Vac
- Local processing and display unit (LPDU) or local processing unit (LPU)
- With or without check source
- With or without heater
- PIS sampler

## ACCESSORIES

- Calibration tools
- Software: MASS2™, RAMVISION™, SIMS2™ applications...
- USB converters
- Seismic qualified wall mounting bracket for LP(D)U
- Ethernet (LPDU version only)



**MIRION**  
TECHNOLOGIES

Copyright © 2024 Mirion Technologies, Inc. or its affiliates. All rights reserved. Mirion, the Mirion logo, and other trade names of Mirion products listed herein are registered trademarks or trademarks of Mirion Technologies, Inc. or its affiliates in the United States and other countries. Third party trademarks mentioned are the property of their respective owners.



CAMSYS™

# iCAM™

## Mobile Alpha Beta Particulate Monitor

Measuring of airborne alpha and beta particulate activity with dynamic radon/thoron alpha and beta background compensation.

### DESCRIPTION

The iCAM intelligent alpha beta continuous air monitor forms part of the CAMSYS product line. It provides robust and reliable monitoring of airborne alpha and beta particulate activity in the workplace. It acts as a simple alarming monitor for operators, while measuring airborne activities in real time with the sophistication required to provide low false alarm rates and high protection levels. At the same time it provides automated facilities which assist supervisors to conduct detailed setup and operational overview.

The iCAM measures airborne alpha and beta particulate activity with dynamic radon/ thoron alpha and beta background compensation. It also provides static or dynamic compensation of beta measurements for gamma background depending on the choice of detector type.

The iCAM has high detection efficiency for both alpha and beta particles and provides good sensitivity for low energy beta detection down to 50 keV.



### FEATURES

- ✓ Continuous monitoring of both alpha and beta activity in air
- ✓ Alpha MCA spectroscopy and separate beta discrimination
- ✓ Excellent low energy beta performance
- ✓ Auto-adaptive spectrometric compensation for radon/thoron
- ✓ Simple and automated checks for calibration, gain and efficiency
- ✓ RS485, RS232 and Ethernet communication interfaces
- ✓ 3 - 6 months data archive with detailed event log

# ICAM™ MOBILE ALPHA BETA PARTICULATE MONITOR

## PHYSICAL CHARACTERISTICS

- Radiation detected: alpha, beta and gamma
- Detector: dual PIPS large area silicon
- Filter type: fixed or moving; FSLW, GFA or FMLB
- Measurement range: in excess of 500 kBq (13.5 µCi) of combined alpha and beta activity deposited on the filter
- Typical measurement ranges:
  - Alpha: 1E-3 to 9E3 Bq/m<sup>3</sup> (1 hour averaging)
  - Beta: 1 to 3.6E5 Bq/m<sup>3</sup> (1 hour averaging)
- Detection efficiencies:
  - Alpha: 24% for all alpha up to 5.7 MeV
  - Beta: 24% for <sup>36</sup>Cl or <sup>90</sup>Sr, 15% for <sup>60</sup>Co
- Typical energy windows:
  - Alpha: 3 MeV to 10 MeV
  - Beta: 50 KeV to 2.5 MeV

## ENVIRONMENTAL CHARACTERISTICS

- Temperature range: +5°C to +50°C (+41°F to +122°F)
- Humidity range: up to 95%, non-condensing
- Protection index: IP54

## PNEUMATIC CHARACTERISTICS

- Airflow measurement: electronic mass flowmeter, of range 15 to 60 l/min (0.5 to 2.1 ft<sup>3</sup>/min)
- Typical indicated flow rate: 37 l/min (1.3 ft<sup>3</sup>/min), controlled by the optional manual flow control valve
- Low and high flow rate limits adjusted by user
- Low differential filter pressure alarm 50 mm Hg (25 in WG)

## MECHANICAL CHARACTERISTICS

- Dimensions: 245 mm x 535 mm x 170 mm (9.6 in x 21 in x 6.7 in)
- Weight: 12 kg (26 lb) without vacuum pump

## ELECTRICAL CHARACTERISTICS

- AC mains frequency: 47-63 Hz
- Voltage: 100-240 V (± 10%)
- Power consumption: 46 VA

- Fuses (internal):
  - Mains protection: rating: 1.6 A, time lag HRC 250V rating
  - Battery protection: rating 2.5 A, time lag LBC
- Battery back-up (for full instrument functionality, excluding external pump): sealed lead acid battery 12 V, 1.2 Ah; typical endurance: 30 min

## SIGNALING

- Red beacon: LED, flashing at 1 Hz for activity alarm
- Green beacon: LED, continuous illumination for normal operation; flashing at 1 Hz for system fault
- Sounder: separate tones for activity and fault alarms; various tones selected by the user

## REFERENCE STANDARDS

- Radiological: IEC61172, IEC60761 parts 1 & 2, IEC61578 and IEC61508 (SIL1); ANSI 42.17B
- EMC: EN61326-1 (2013), EN61326-2-1 (2013), IEC61010-1 (3rd edition), UL61010-1 (2012) and CAN/CSA C22.2 No. 61010-1 (2012)

## OPTIONS

- Moving filter version
- Full-function area gamma alarm monitor capability using the optional G64 detector
- TCAM PIPS acid resistant detector and flowmeter
- Optional Input /Output expansion
- Optional amber beacon for level 1 alarms (flashing at 1 Hz)

## ACCESSORIES

- Bench stand or trolley/cart mountings
- Wall mounting plate
- Air inlet to pipe adaptor
- Flow regulator valve
- Nitto piston air pumps (low noise)
- Rietschle rotary vane air pumps (high capacity, for high dust loading environments)
- iConfig configuration software
- Tablet configuration unit
- RS232 connection cable



**MIRION**  
TECHNOLOGIES

Copyright © 2023 Mirion Technologies, Inc. or its affiliates. All rights reserved. Mirion, the Mirion logo, and other trade names of Mirion products listed herein are registered trademarks or trademarks of Mirion Technologies, Inc. or its affiliates in the United States and other countries. Third party trademarks mentioned are the property of their respective owners.



CAMSYS™

# iCAM RH™

## Remote Head



Sampling head and detector separated from main control and display unit.

### DESCRIPTION

The iCAM RH head forms part of the CAMSYS product line. In many CAM (Continuous Air Monitor) stack or duct sampling applications the optimum sampling point may be a long distance from a convenient mounting location for the display and control unit. This can lead to the use of long sampling pipes, causing increased losses due to sample deposition in the pipes, and delays in response to releases.

The iCAM Remote Head option provides a solution to both of these problems by allowing the user to separate the sampling head and pump from the control and display unit – by up to 50 m (164 ft) if required. It allows the display unit to be positioned for easy access and best visibility and audibility of the alarms.

### FEATURES

- ✓ Up to 50 m from head to controller
- ✓ Amplifiers, flow and DP measurement all in the head
- ✓ Avoids particulate losses in long sampling pipes
- ✓ Faster response time
- ✓ Lower pump loading – no pipes between head and controller
- ✓ Allows sampling in inaccessible locations
- ✓ Square format allows mounting with air inlet on top, left or right hand side

# iCAM RH™ REMOTE HEAD

## ICAM REMOTE HEAD

The remote head can have either the fixed filter or the moving filter mechanism mounted onto it. It contains the amplifiers and bias generator to run the PIPS® detector(s) and transmits buffered analogue signals for the alpha/beta detector and the gamma detector to the iCAM control unit up to 50 m away through two coaxial cables. These signals are received in the iCAM controller via a special interface board and are then treated and processed exactly as if the sampling head and detectors were mounted directly on top of the iCAM as in a standard unit. The performance of the remote head system is thus identical to the performance of the standard unit.

The remote head also contains the standard iCAM flow and differential pressure sensors. The values from these are read continuously by a processor in the head and are transmitted to the control unit via an RS-485 serial link whenever the processor in the head is polled for data by the controller. Nominal 12 Vdc power is also supplied to the head from the controller via the RS-485 cable connection. If the cable connection to the head is broken then this is immediately detected by the controller and the Monitoring LED on the front panel is extinguished and the Red beacon flashes.

A fault screen is also displayed:

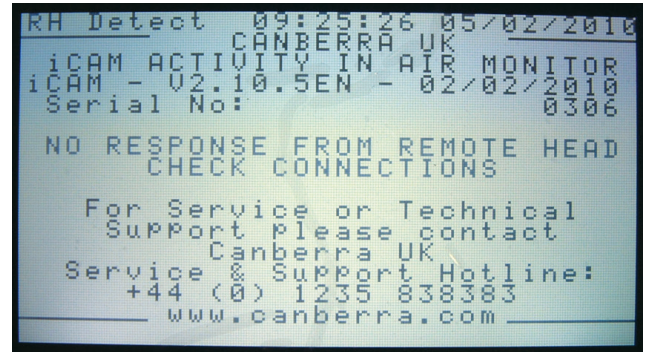

Normal operation is restored automatically once communications are restored. Calibration of the head is carried out as with a standard iCAM. There are no adjustments in the head. If any adjustments are required during calibration these are made at the control unit where the user can read the calibration screens and adjust accordingly.

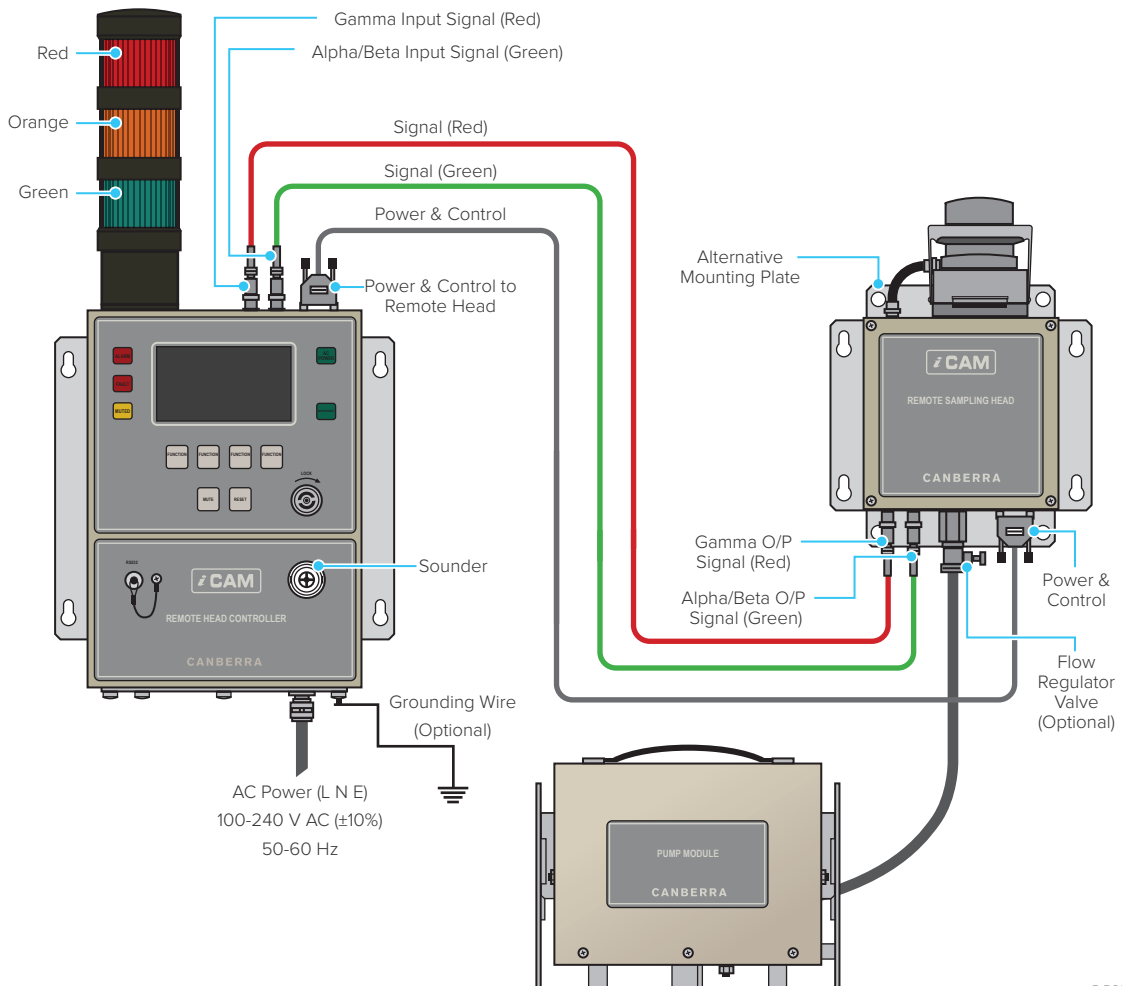



## iCAM RH™ REMOTE HEAD

### PHYSICAL CHARACTERISTICS

- All performance specifications are identical to the standard iCAM version with the same head/filter.

### MECHANICAL CHARACTERISTICS

- Dimensions:
  - Enclosure only: 175 mm x 175 mm x 128 mm (6.9 in x 6.9 in x 5 in)
  - Overall (with fixed filter air inlet and exhaust pipe adaptor): 318 mm x 175 mm x 128 mm (12.5 in x 6.9 in x 5 in)
- Weight (with fixed filter air inlet): 5.4 kg (11.9 lb)

### ICAM RH CONNECTIONS

FUNCTION	DESCRIPTION	PIN FUNCTION
Gamma output	50 Ohm BNC socket (Red)	Analog signal (max 10 V)
Alpha/beta output	50 Ohm BNC socket (Green)	Analog signal (max 10 V)
Power & control	9 way D plug	Power and RS485 data

- Earth Stud – M5 earth stud for optional chassis ground.

### ICAM/RHC CONTROLLER CONNECTIONS

FUNCTION	DESCRIPTION	PIN FUNCTION
Gamma output	50 Ohm BNC socket (Red)	Analog signal (max 10 V)
Alpha/beta output	50 Ohm BNC socket (Green)	Analog signal (max 10 V)
Power & control	9 way D plug	Power and RS485 data

- Cabling:
  - Two coaxial cable: MM15/50 superscreened cable
  - Power and control cable: Belden type 8162 screened twin twisted pair

### SIGNALING

- Single green power LED

### OPTIONS

- Fixed filter head or moving filter head
- Cable length: 2 m, 5 m, 10 m, 15 m, 20 m or 50 m (6.5 ft, 16.4 ft, 32.8 ft, 49.2 ft, 65.6 ft or 164 ft)

### ACCESSORIES

- Most standard iCAM accessories can be used with the Remote Head iCAMs



Copyright © 2024 Mirion Technologies, Inc. or its affiliates. All rights reserved. Mirion, the Mirion logo, and other trade names of Mirion products listed herein are registered trademarks or trademarks of Mirion Technologies, Inc. or its affiliates in the United States and other countries. Third party trademarks mentioned are the property of their respective owners.



CAMSYS™

# BAC™

## Access Alarm Unit

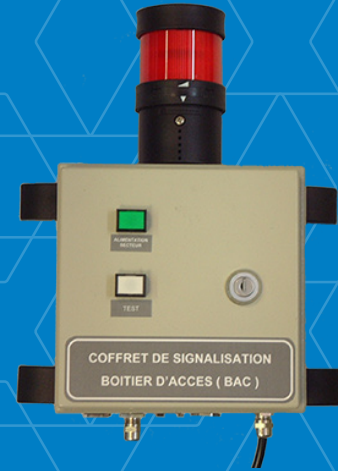

**Access alarm unit for radiation monitoring with iCAM alpha and beta continuous air monitor**

### DESCRIPTION

The BAC access alarm unit has been designed to work with the iCAM alpha and beta monitor and is used to remotely display an alarm condition signalled from any one of up to five iCAM units connected to it.

The display device is a red LED beacon mounted on the top of the unit. A green LED indicator on the front panel is illuminated in normal operation when the unit is powered using a local AC mains power supply.

A front panel push button is used to test that the beacon is operational. The unit also incorporates an internal relay to signal a power failure via two pairs of change-over contacts which change state when the relay de-energises at poweroff. The front panel is fixed in position using a Ronis key lock.

### FEATURES

- ✓ Until 5 iCAM units connected
- ✓ Operates from any mains supply from 90V to 250V

## BAC™ ACCESS ALARM UNIT

### ENVIRONMENTAL CHARACTERISTICS

- Temperature range: 0 °C to +40 °C (+32 °F to 104 °F)
- Humidity range: up to 95%, non-condensing
- Protection index: IP54

### MECHANICAL CHARACTERISTICS

- Dimensions: 340 mm x 281 mm x 173 mm  
(13.4 in x 11.06 in x 6.8 in)
- Weight: 3.6 kg (7.9 lb)

### ELECTRICAL CHARACTERISTICS

- Voltage: 90 to 250 VAC
- Frequency: 47 to 440 Hz
- Power: 18 W

### SIGNALING

- Red indicator: LED indicating that an alarm state has been tripped in one of the monitoring systems to which the unit is connected
- Green indicator: LED illuminated when power is applied
- White indicator: LED on front panel push button, illuminated when the button is pressed

### REFERENCE STANDARDS

- EMC: EN 61326-1:2006, IEC 61000-4-4 severity level 3, IEC 61000-4-11, IEC 61000-4-2, IEC 61000-4-3, IEC 61000-4-4, IEC 61000-4-5, IEC 61000-4-12 and EN 55022, severity class A

### ACCESSORIES

- Horizontal or vertical mounting bracket



**MIRION**  
TECHNOLOGIES

Copyright © 2024 Mirion Technologies, Inc. or its affiliates. All rights reserved. Mirion, the Mirion logo, and other trade names of Mirion products listed herein are registered trademarks or trademarks of Mirion Technologies, Inc. or its affiliates in the United States and other countries. Third party trademarks mentioned are the property of their respective owners.



CAMSYS™

# BAS™

## D2 Slave Alarm Unit



**Slave alarm unit for radiation monitoring with iCAM alpha and beta continuous air monitor**

### DESCRIPTION

The BAS D2 slave alarm unit has been designed to work with the iCAM alpha and beta monitor and is used to remotely display alarm conditions signalled from an iCAM unit connected to it. The enunciator devices are a red, amber and green LED beacon stack mounted on the top of the unit and two tone sounder mounted on the front. The beacon stack and the sounder mimic the visual and audio signals of the attached iCAM.

A green LED indicator on the front panel and the green beacon are illuminated in normal operation when the unit is powered using a local AC mains power supply. A front panel push button is used to test that the beacons and sounder are operational. The unit also incorporates two internal relays to: signal a fault via two pairs of changeover contacts which de-energise if the unit has an internal fault; signal that the unit is in test mode again via two pairs of change over contacts which de-energise upon activation. The dual network BAS is designed to operate with two network modes: RS485 and Ethernet.

### FEATURES

- ✓ Remote display of a iCAM visual and sound signaling
- ✓ Operates from any mains supply from 90V to 250V
- ✓ Exists in dual network version: RS485 and Ethernet

## **BAS™ D2 SLAVE ALARM UNIT**

### **ENVIRONMENTAL CHARACTERISTICS**

- Temperature range: 0 °C to +40 °C (+32 °F to 104 °F)
- Humidity range: up to 95%, non-condensing
- Protection index: IP54

### **MECHANICAL CHARACTERISTICS**

- Dimensions: 514 mm x 281 mm x 173 mm  
(20.2 in x 11.06 in x 6.8 in)
- Weight: 4.8 kg (10.6 lb)

### **ELECTRICAL CHARACTERISTICS**

- Voltage: 90 to 250 VAC
- Frequency: 47 to 440 Hz
- Power: 24 W

### **SIGNALING**

- Beacon stack and loudspeaker: they mimic the visual and sound alarms output by the attached iCAM
- Green indicator: LED illuminated when power is applied
- White indicator: LED on front panel push button, illuminated when the button is pressed

### **REFERENCE STANDARDS**

- EMC: EN 61326-1:2006, IEC 61000-4-4 severity level 3, IEC 61000-4-11, IEC 61000-4-2, IEC 61000-4-3, IEC 61000-4-4, IEC 61000-4-5, IEC 61000-4-12 and EN 55022, severity class A

### **VERSIONS**

- Version for dual network with port for RS485 network and RJ45 connector RJ45 for Ethernet

### **ACCESSORIES**

- Horizontal or vertical mounting bracket



**MIRION**  
TECHNOLOGIES

Copyright © 2024 Mirion Technologies, Inc. or its affiliates. All rights reserved. Mirion, the Mirion logo, and other trade names of Mirion products listed herein are registered trademarks or trademarks of Mirion Technologies, Inc. or its affiliates in the United States and other countries. Third party trademarks mentioned are the property of their respective owners.



RAMSYS™

# IM 201L™

## Iodine Monitor

Continuously measuring the gamma volumetric activity of radioactive iodine samples, in both molecular and organic forms contained in air drawn from stacks, ventilation ducts or working areas.

### DESCRIPTION

The IM 201L monitor forms part of the RAMSYS product line.

It has been developed to continuously measure the gamma volumetric activity of radioactive iodine samples, in both molecular and organic forms (methyl iodide), contained in air drawn from stacks, ventilation ducts or working areas.

An NaI scintillation detector faces the activated charcoal cartridge in which radioactive iodine is trapped. The proximity of the detector and the cartridge, enclosed within a  $4\pi/5$  cm (4 /2 in) lead shielding, serves to optimize detection efficiency. A  $^{241}\text{Am}$  radioactive source built into the NaI scintillator allows compensation of temperature and aging related drifts. The spectrometry capability, based on a 1024-channel spectrum analysis, allows radio iodine isotope localization.



### FEATURES

- ✓ Embedded  $^{241}\text{Am}$  source for energy spectrum stabilization against temperature changes and aging
- ✓ 1024-channel spectrum analysis
- ✓ Effluent trapping of both molecular and organic forms of iodine

## IM 201L™ IODINE MONITOR

### PHYSICAL CHARACTERISTICS

- Radiation detected: gamma
- Detector: 1¼"x1" NaI(Tl) scintillator + PMT
- Iodine cartridge: 57.7 mm (2.27 in)
- Energy range: 100 keV to 3 MeV
- Typical energy windows: 314 - 414 keV (<sup>131</sup>I, E<sub>γ</sub> 364.5 keV)
- 1024-channel spectrum
- Typical measurement range: 3.7 to 3.7 10<sup>+6</sup> Bq/m<sup>3</sup> (10<sup>-10</sup> to 10<sup>-4</sup> μCi/cc)

### ENVIRONMENTAL CHARACTERISTICS

- Normal temperature: +5 °C to +40 °C (+41 °F to +104 °F)
- Temperature limit: -5 °C to +55 °C (+23 °F to +131 °F)
- MTBF: > 20 000 hours, with preventive maintenance
- TID: 100 Gy (10<sup>+4</sup> rad)

### PNEUMATIC CHARACTERISTICS

- Standard flow rate: 35 l/min (1.24 scfm)
- Pressure drop: according to the filter dust loading

### MECHANICAL CHARACTERISTICS

- Dimensions: 864 mm x 725 mm x 440 mm (34 in x 28.5 in x 17.3 in)
- Weight: ~ 220 kg (~ 495 lb)
- Color: gray RAL 7030 (decontaminable paint)
- Inlet tube connection: Ø 12 mm OD (1/2 in)
- Outlet tube connection: Ø 12 mm OD (1/2 in)

### ELECTRICAL CHARACTERISTICS

- Power supply: 230 Vac – 50 Hz or 120 Vac – 60 Hz
- Data link outputs: one RS232 and two isolated RS485
- Alarm relays: three SPDT relays
- I/O: two isolated analog outputs and one isolated analog input (0/4-20 mA)

### SIGNALING (APPLICABLE TO LPDU ONLY)

- Alphanumeric display: measurement, status...
- Sound alarm: buzzer 90 dBA at 1 meter
- Visual alarm: three lights (red, yellow, green)

### REFERENCE STANDARDS

- Nuclear: IEC60761
- EMC: 2014/30/EU and 2014/35/EU, IEC61000-6-2 and IEC61000-6-4

### VERSIONS

- 230 Vac or 120 Vac
- Local processing and display unit (LPDU) or local processing unit (LPU)
- With or without dust filter holder
- Pumping unit
- Monitor wall or floor fixing plate

### ACCESSORIES

- Calibration tools
- Software: MASS2™, RAMVISION™, SIMS2™ applications...
- USB converters



**MIRION**  
TECHNOLOGIES

Copyright © 2023 Mirion Technologies, Inc. or its affiliates. All rights reserved. Mirion, the Mirion logo, and other trade names of Mirion products listed herein are registered trademarks or trademarks of Mirion Technologies, Inc. or its affiliates in the United States and other countries. Third party trademarks mentioned are the property of their respective owners.



RAMSYS™

# IM 201M™

## Mobile Iodine Monitor



Continuously measuring the gamma volumetric activity of radioactive iodine samples contained in air drawn from stacks, ventilation ducts or working areas.

### DESCRIPTION

The IM 201M monitor forms part of the RAMSYS product line.

It has been developed to continuously measure the gamma volumetric activity of radioactive iodine samples, in both molecular and organic forms (methyl iodide), contained in air drawn from stacks, ventilation ducts or working areas.

An NaI scintillation detector faces the activated charcoal cartridge in which radioactive iodine is trapped. The proximity of the detector and the cartridge, enclosed within a 4 / 5 cm (4 / 2 in) lead shielding, serves to optimize detection efficiency. A radioactive <sup>241</sup>Am source built into the NaI scintillator allows compensation of temperature and aging related drifts. The spectrometry capability, based on a 1024-channel spectrum analysis, allows radio iodine isotope localization.

### FEATURES

- ✓ Embedded <sup>241</sup>Am source for energy spectrum stabilization against temperature changes and aging
- ✓ 1024-channel spectrum analysis
- ✓ Effluent trapping of both molecular and organic forms of iodine
- ✓ Can be used as temporary bypass for IM 201S™ or IM 201L™ to maintain full monitoring capability during maintenance



## IM 201M™ MOBILE IODINE MONITOR

### PHYSICAL CHARACTERISTICS

- Radiation detected: gamma
- Detector: 1¼"x1" NaI(Tl) scintillator + PMT
- Iodine cartridge: 57.7 mm (2.27 in)
- Energy range: 100 keV to 3 MeV
- Typical energy windows: 314 - 414 keV (<sup>131</sup>I, E<sub>γ</sub> 364.5 keV)
- 1024-channel spectrum
- Typical measurement range: 3.7 to 3.7 10<sup>+6</sup> Bq/m<sup>3</sup> (10<sup>-10</sup> to 10<sup>-4</sup> μCi/cc)

### ENVIRONMENTAL CHARACTERISTICS

- Normal temperature: +5 °C to +40 °C (+41 °F to +104 °F)
- Temperature limit: -5 °C to +55 °C (+23 °F to +131 °F)
- MTBF: > 20 000 hours, with preventive maintenance
- TID: 100 Gy (10<sup>+4</sup> rad)

### PNEUMATIC CHARACTERISTICS

- Standard flow rate: 35 l/min (1.24 scfm)
- Pressure drop: according to the filter dust loading

### MECHANICAL CHARACTERISTICS

- Dimensions: 1406 mm x 520 mm x 700 mm (55.4 in x 20.5 in x 27.6 in)
- Weight: ~ 200 kg (~ 441 lb)
- Color: gray RAL 7030 (decontaminable paint)
- Inlet tube connection: Ø 12 mm OD (1/2 in)

### ELECTRICAL CHARACTERISTICS

- Power supply: 230 Vac – 50 Hz or 120 Vac – 60 Hz
- Data link outputs: one RS232 and two isolated RS485
- Alarm relays: three SPDT relays
- I/O: two isolated analog outputs and one isolated analog input (0/4-20 mA)

### SIGNALING

- Alphanumeric display: measurement, status...
- Sound alarm: buzzer 90 dBA at 1 meter
- Visual alarm: three lights (red, yellow, green)

### REFERENCE STANDARDS

- Nuclear: IEC 60761
- EMC: 2014/30/EU and 2014/35/EU, IEC 61000-6-2 and IEC 61000-6-4

### VERSIONS

- 230 Vac or 120 Vac
- With or without dust filter holder
- With or without output dust filter

### ACCESSORIES

- Calibration tools
- Software: MASS2™, RAMVISION™, SIMS2™ applications...
- USB converters



**MIRION**  
TECHNOLOGIES

Copyright © 2024 Mirion Technologies, Inc. or its affiliates. All rights reserved. Mirion, the Mirion logo, and other trade names of Mirion products listed herein are registered trademarks or trademarks of Mirion Technologies, Inc. or its affiliates in the United States and other countries. Third party trademarks mentioned are the property of their respective owners.



RAMSYS™

# IM 201S™

## Seismic Iodine Monitor

Continuously measuring the gamma volumetric activity of radioactive iodine samples, in both molecular and organic forms contained in air drawn from stacks, ventilation ducts or working areas. Can withstand seismic conditions.

### DESCRIPTION

The IM 201S monitor forms part of the RAMSYS product line.

It has been developed to continuously measure the gamma volumetric activity of radioactive iodine samples, in both molecular and organic forms (methyl iodide), contained in air drawn from stacks, ventilation ducts or working areas.

An NaI scintillation detector faces the activated charcoal cartridge in which radioactive iodine is trapped. The proximity of the detector and the cartridge, enclosed within a 4/5 cm (4/2 in) lead shielding, serves to optimize detection efficiency.

A radioactive <sup>241</sup>Am source built into the NaI scintillator allows compensation of temperature and aging related drifts. The spectrometry capability, based on a 1024-channel spectrum analysis, allows radio iodine isotope localization.

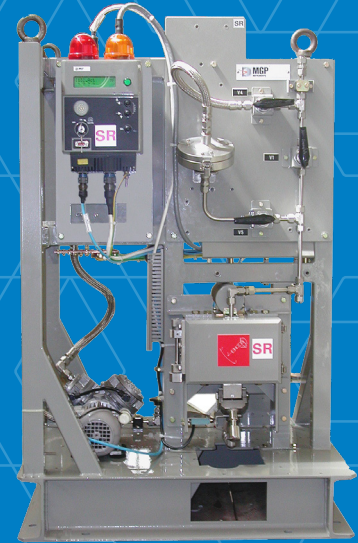

### FEATURES

- ✓ Embedded <sup>241</sup>Am source for energy spectrum stabilization against temperature changes and aging
- ✓ 1024-channel spectrum analysis
- ✓ 1E qualification and embedded safety related software
- ✓ Available under 10 CFR 50 App. B, IEC 61226 and ASME NQA-1 programs for safety related applications

# IM 201S™ SEISMIC IODINE MONITOR

## PHYSICAL CHARACTERISTICS

- Radiation detected: gamma
- Detector: 1¼"x1" NaI(Tl) scintillator + PMT
- Iodine cartridge: 57.7 mm (2.27 in)
- Energy range: 100 keV to 3 MeV
- Typical energy windows: 314 - 414 keV (<sup>131</sup>I, E<sub>γ</sub> 364.5 keV)
- 1024-channel spectrum
- Typical measurement range: 3.7 to 3.7 10<sup>+6</sup> Bq/m<sup>3</sup> (10<sup>-10</sup> to 10<sup>-4</sup> μCi/cc)

## ENVIRONMENTAL CHARACTERISTICS

- Normal temperature: +5 °C to +40 °C (+41 °F to +104 °F)
- Temperature limit: -5 °C to +55 °C (+23 °F to +131 °F)
- MTBF: > 20 000 hours, with preventive maintenance
- TID: 100 Gy (10<sup>+4</sup> rad)

## PNEUMATIC CHARACTERISTICS

- Standard flow rate: 35 l/min (1.24 scfm)
- Pressure drop: according to the filter dust loading

## MECHANICAL CHARACTERISTICS

- Dimensions: 1280 mm x 830 mm x 680 mm (50.4 in x 32.7 in x 26.8 in)
- Weight: ~ 300 kg (~ 661 lb)
- Color: gray RAL 7030 (decontaminable paint)
- Inlet tube connection: Ø 12 mm OD (1/2 in)
- Outlet tube connection: Ø 12 mm OD (1/2 in)

## ELECTRICAL CHARACTERISTICS

- Power supply: refer to possible versions
- Data link outputs: one RS232 and two isolated RS485
- Alarm relays: three SPDT relays
- I/O: two isolated analog outputs and one isolated analog input (0/4-20 mA)

## SIGNALING

- Alphanumeric display: measurement, status...
- Sound alarm: buzzer 90 dBA at 1 meter
- Visual alarm: three lights (red, yellow, green)

## REFERENCE STANDARDS

- Nuclear: IEC 60761
- Environmental: IEC/IEEE 60780-323
- Seismic: IEC 60980, IEEE 344
- EMC: 2014/30/EU and 2014/35/EU, EPRI 102323, RG 1.180, IEC 61000-6-2 and IEC 61000-6-4

## VERSIONS

- 230 Vac or 230 Vac + 400 Vac 3Ø or 120 Vac + 400 Vac 3Ø
- Solenoid check source
- With or without dust filter holder
- Gas grab sampler ports

## ACCESSORIES

- Calibration tools
- Software: MASS2™, RAMVISION™, SIMS2™ applications...
- USB converters
- Ethernet



**MIRION**  
TECHNOLOGIES

Copyright © 2024 Mirion Technologies, Inc. or its affiliates. All rights reserved. Mirion, the Mirion logo, and other trade names of Mirion products listed herein are registered trademarks or trademarks of Mirion Technologies, Inc. or its affiliates in the United States and other countries. Third party trademarks mentioned are the property of their respective owners.



RAMSYS™

# IM 203M™

## Mobile Iodine Monitor



**Compact, lightweight and movable to measure the gamma volumetric activity of a radioactive iodine sampler.**

### DESCRIPTION

The IM 203M monitor forms part of the RAMSYS product line.

It has been developed to continuously measure the gamma volumetric activity of radioactive iodine samples, in both molecular and organic forms (methyl iodide), contained in air drawn from stacks, ventilation ducts or working areas.

An NaI scintillation detector faces the activated charcoal cartridge in which radioactive iodine is trapped. The proximity of the detector and the cartridge, enclosed within a 4 1/2 cm (4 1/8 in) lead shielding, serves to optimize detection efficiency. A radioactive <sup>241</sup>Am source built into the NaI scintillator allows compensation of temperature and aging related drifts. The spectrometry capability, based on a 1024-channel spectrum analysis, allows radio iodine isotope localization.

### FEATURES

- ✓ Embedded <sup>241</sup>Am source for energy spectrum stabilization against temperature changes and aging
- ✓ 1024-channel spectrum analysis
- ✓ Effluent trapping of both molecular and organic forms of iodine
- ✓ Can be used as temporary bypass for IM 201S™ or IM 201L™ to maintain full monitoring capability during maintenance

## IM 203M™ MOBILE IODINE MONITOR

### PHYSICAL CHARACTERISTICS

- Radiation detected: gamma
- Detector: 1¼"x1" NaI(Tl) scintillator + PMT
- Iodine cartridge: 57.7 mm (2.27 in)
- Energy range: 100 keV to 3 MeV
- Typical energy windows: 314 - 414 keV (<sup>131</sup>I, E<sub>γ</sub> 364.5 keV)
- 1024-channel spectrum
- Typical measurement range: 3.7 to 3.7 10<sup>+6</sup> Bq/m<sup>3</sup> (10<sup>-10</sup> to 10<sup>-4</sup> μCi/cc)

### ENVIRONMENTAL CHARACTERISTICS

- Normal temperature: +5 °C to +40 °C (+41 °F to +104 °F)
- Temperature limit: -5 °C to +55 °C (+23 °F to +131 °F)
- MTBF: > 20 000 hours, with preventive maintenance
- TID: 100 Gy (10<sup>+4</sup> rad)

### PNEUMATIC CHARACTERISTICS

- Standard flow rate: 35 l/min (1.24 scfm)
- Pressure drop: according to the filter dust loading

### MECHANICAL CHARACTERISTICS

- Dimensions: 973 mm x 350 mm x 480 mm (38.3 in x 13.8 in x 18.9 in)
- Weight: 55 kg (121 lb)
- Color: gray RAL 7030 (decontaminable paint)
- Inlet tube connection: Ø 12 mm OD (1/2 in)

### ELECTRICAL CHARACTERISTICS

- Power supply: 230 Vac – 50 Hz or 120 Vac – 60 Hz
- Data link outputs: one RS232 and two isolated RS485
- Alarm relays: three SPDT relays
- I/O: two isolated analog outputs and one isolated analog input (0/4-20 mA)

### SIGNALING

- Alphanumeric display: measurement, status...
- Sound alarm: buzzer 90 dBA at 1 meter
- Visual alarm: three lights (red, yellow, green)

### REFERENCE STANDARDS

- Nuclear: IEC 60761, IEC 61171
- EMC: 2014/30/EU and 2014/35/EU, IEC 61000-6-2 and IEC 61000-6-4

### VERSIONS

- 230 Vac or 120 Vac
- With or without dust filter holder
- With or without output dust filter

### ACCESSORIES

- Calibration tools
- Software: MASS2™, RAMVISION™, SIMS2™ applications...
- USB converters



**MIRION**  
TECHNOLOGIES

Copyright © 2024 Mirion Technologies, Inc. or its affiliates. All rights reserved. Mirion, the Mirion logo, and other trade names of Mirion products listed herein are registered trademarks or trademarks of Mirion Technologies, Inc. or its affiliates in the United States and other countries. Third party trademarks mentioned are the property of their respective owners.



RAMSYS™

# NGM 202L™

## Low Range Noble Gas Monitor

Continuously monitoring the volumetric activity of noble gas in radioactive effluent gaseous samples.

### DESCRIPTION

The NGM 202L monitor forms part of the RAMSYS product line.

The monitor was developed to continuously sample the volumetric activity of noble gas in a radioactive effluent gaseous sample. This monitor can operate as a stand-alone device or in conjunction with a particulate monitor (ABPM 201), iodine monitor (IM 201) and with a high range noble gas monitor (NGM 203) to form a very wide range monitoring system.



### FEATURES

- ✓ Dynamic gamma radiation compensation
- ✓ Compact and reliable
- ✓ Minimum periodic maintenance

# NGM 202L™ LOW RANGE NOBLE GAS MONITOR

## PHYSICAL CHARACTERISTICS

- Radiation detected: alpha, beta, gamma
- Detector: dual large differential ionization chamber
- Sampling chamber: 10 l (10000 cc) each
- Energy range: 5 keV to 8 MeV
- Typical measurement range:  $10^{+4}$  to  $3.7 \cdot 10^{+9}$  Bq/m<sup>3</sup> ( $2.7 \cdot 10^{-7}$  to  $10^{-1}$   $\mu$ Ci/cc)

## ENVIRONMENTAL CHARACTERISTICS

- Normal temperature: +5 °C to +40 °C (+41 °F to +104 °F)
- Temperature limit: -5 °C to +55 °C (+23 °F to +131 °F)
- MTBF: > 20 000 hours, with preventive maintenance
- TID: 100 Gy ( $10^{+4}$  rad)

## PNEUMATIC CHARACTERISTICS

- Standard flow rate: 35 l/min (1.24 scfm)
- Pressure drop: according to the filter dust loading

## MECHANICAL CHARACTERISTICS

- Dimensions: 1354 mm x 825 mm x 440 mm (53.3 in x 32.5 in x 17.3 in)
- Weight: ~ 96 kg (~ 212 lb)
- Color: gray RAL 7030 (decontaminable paint)
- Inlet tube connection:  $\varnothing$  12 mm OD (1/2 in)
- Outlet tube connection:  $\varnothing$  12 mm OD (1/2 in)

## ELECTRICAL CHARACTERISTICS

- Power supply: 230 Vac – 50 Hz or 120 Vac – 60 Hz
- Data link outputs: one RS232 (LPDU only) and two isolated RS485
- Alarm relays: three SPDT relays
- I/O: two isolated analog outputs and one isolated analog input (0/4-20 mA)

## SIGNALING (APPLICABLE TO LPDU ONLY)

- Alphanumeric display: measurement, status...
- Sound alarm: buzzer 90 dBA at one meter
- Visual alarm: three lights (red, yellow, green)

## REFERENCE STANDARDS

- Nuclear: IEC 60761-1 and IEC 60761-3
- EMC: 2014/30/EU and 2014/35/EU, IEC 61000-6-2 and IEC 61000-6-4

## VERSIONS

- 230 Vac or 120 Vac
- Local processing and display unit (LPDU) or local processing unit (LPU)
- Pumping unit
- With or without RS485 junction box
- Monitor wall or floor mounting plate

## ACCESSORIES

- Calibration tools
- Software: MASS2™, RAMVISION™, SIMS2™ applications...
- USB converters
- Dust filter holder
- PIS sampler



**MIRION**  
TECHNOLOGIES

Copyright © 2024 Mirion Technologies, Inc. or its affiliates. All rights reserved. Mirion, the Mirion logo, and other trade names of Mirion products listed herein are registered trademarks or trademarks of Mirion Technologies, Inc. or its affiliates in the United States and other countries. Third party trademarks mentioned are the property of their respective owners.



RAMSYS™

# NGM 203S™

## Seismic High Range Noble Gas Monitor

Sampling air in discharge stacks, ventilation ducts or working areas. Can withstand seismic conditions.

### DESCRIPTION

The NGM 203S monitor forms part of the RAMSYS product line.

It has been developed to sample air in discharge stacks, ventilation ducts or working areas. A flow through ionization chamber is enclosed in a 4 π/5 cm lead shielding.

This monitor is designed to meet the noble gas monitoring requirements set forth by the USA Regulatory Guide 1.97 and it can be used before, during and after an accident. It can operate in conjunction with a shielded particulate and iodine sampler (PIS 203) and with a low range noble gas monitor (NGM 204) to form a wide range monitoring system.



### FEATURES

- ✓ Designed for accident and post-accident conditions
- ✓ Durable detector without any electronic or radiation degraded components
- ✓ 1E qualification and embedded safety related software
- ✓ RG 1.97 and IEC60951 compliance
- ✓ Available under 10 CFR 50 App. B, ASME NQA-1 and IEC61226 programs for safety related applications



# NGM 203S™ SEISMIC HIGH RANGE NOBLE GAS MONITOR

## PHYSICAL CHARACTERISTICS

- Radiation detected: alpha, beta and gamma
- Detector: flow-through ionization chamber (CHMC01)
- Sensitive volume: 100 ml (100 cc)
- Energy range: 5 keV to 3 MeV
- Typical measurement range (for RG 1.97 applications):
  - $^{85}\text{Kr}$ :  $4 \cdot 10^{+6}$  to  $10^{+16}$  Bq/m<sup>3</sup> ( $1.08 \cdot 10^{-4}$  to  $2.7 \cdot 10^{+5}$   $\mu\text{Ci/cc}$ )
  - $^{133}\text{Xe}$ :  $10^{+6}$  to  $3.7 \cdot 10^{+15}$  Bq/m<sup>3</sup> ( $2.7 \cdot 10^{-5}$  to  $10^{+5}$   $\mu\text{Ci/cc}$ )
- Typical measurement range (for IEC60951 applications):
  - $^{85}\text{Kr}$ :  $4 \cdot 10^{+6}$  to  $5.55 \cdot 10^{+15}$  Bq/m<sup>3</sup>  
( $1.08 \cdot 10^{-4}$  to  $1.5 \cdot 10^{+5}$   $\mu\text{Ci/cc}$ )
  - $^{133}\text{Xe}$ :  $10^{+6}$  to  $1.85 \cdot 10^{+15}$  Bq/m<sup>3</sup> ( $2.7 \cdot 10^{-5}$  to  $5 \cdot 10^{+4}$   $\mu\text{Ci/cc}$ )

## ENVIRONMENTAL CHARACTERISTICS

- Normal temperature: +10 °C to +40 °C (+50 °F to +104 °F)
- Temperature limit: -5 °C to +55 °C (+23 °F to +131 °F)
- MTBF: > 50 000 hours, with preventive maintenance
- TID (processing unit): 100 Gy ( $10^{+4}$  rad)

## PNEUMATIC CHARACTERISTICS

- Standard flow rate: 35 l/min (1.24 scfm)
- Pressure drop: according to the filter dust loading

## MECHANICAL CHARACTERISTICS

- Dimensions: 1305 mm x 830 mm x 680 mm  
(51.4 in x 32.7 in x 26.8 in)
- Weight: ~ 310 kg (~ 684 lb)
- Color: gray RAL 7030 (decontaminable paint)
- Inlet tube connection:  $\varnothing$  12 mm OD (1/2 in)
- Outlet tube connection:  $\varnothing$  12 mm OD (1/2 in)

## ELECTRICAL CHARACTERISTICS

- Power supply: refer to possible versions
- Data link outputs: one RS232 and two isolated RS485
- Alarm relays: three SPDT relays
- I/O: two isolated analog outputs (0/4-20 mA)

## SIGNALING

- Alphanumeric display: measurement, status...
- Sound alarm: buzzer 90 dBA at 1 meter
- Visual alarm: three lights (red, yellow, green)

## REFERENCE STANDARDS

- Nuclear: IEC60951, RG 1.97
- Environmental: IEC60780, IEEE323
- Seismic: IEC60980, IEEE344
- EMC: 2014/30/EU and 2014/35/EU, EPRI 102323, RG1.180, IEC61000-6-2 and IEC61000-6-4

## VERSIONS

- 230 Vac or 230 Vac + 400 Vac 3 $\varnothing$  or 120 Vac + 400 Vac 3 $\varnothing$
- PIS sampler
- Dust filter holder
- Gas grab sampler ports
- Heater

## ACCESSORIES

- Calibration tools
- Software: MASS2™, RAMVISION™, SIMS2™ applications...
- USB converters
- Local and remote display units



**MIRION**  
TECHNOLOGIES

Copyright © 2023 Mirion Technologies, Inc. or its affiliates. All rights reserved. Mirion, the Mirion logo, and other trade names of Mirion products listed herein are registered trademarks or trademarks of Mirion Technologies, Inc. or its affiliates in the United States and other countries. Third party trademarks mentioned are the property of their respective owners.



RAMSYS™

# NGM 204L™

## Low Range Noble Gas Monitor



Sampling air in discharge stacks,  
ventilation ducts or working areas.

### DESCRIPTION

The NGM 204L monitor from the RAMSYS product line has been developed to sample air in discharge stacks, ventilation ducts or working areas.

The dual silicon diode detector integrated in a 4/5 cm (4/2 in) lead shielded sample volume guarantees high reliability of the measurements.

The first silicon diode detects the beta/gamma radiation from sample volume and the gamma ambient radiation (background). The second one detects gamma radiation from sample volume and the gamma ambient radiation. This allows noble gas beta measurement with dynamic gamma compensation by the processing algorithms.

### FEATURES

- ✓ Dynamic gamma radiation compensation
- ✓ Calculation of the total released activity through a stack, when the flow rate signal is provided
- ✓ Compact and reliable
- ✓ Minimum periodic maintenance

# NGM 204L™ LOW RANGE NOBLE GAS MONITOR

## PHYSICAL CHARACTERISTICS

- Radiation detected: beta and gamma
- Detector: dual large area silicon
- Sampling chamber: 300 ml (300 cc)
- Typical energy windows:
  - Beta: 80 keV à 2.5 MeV
  - Gamma: 80 keV à 2.5 MeV
- Typical measurement range:
  - $^{85}\text{Kr}$ :  $3.7 \cdot 10^{+4}$  to  $3.7 \cdot 10^{+14}$  Bq/m<sup>3</sup> ( $10^{-6}$  to  $10^{+4}$   $\mu\text{Ci/cc}$ )
  - $^{133}\text{Xe}$ :  $3.7 \cdot 10^{+4}$  to  $1.8 \cdot 10^{+13}$  Bq/m<sup>3</sup> ( $10^{-6}$  to  $5 \cdot 10^{+2}$   $\mu\text{Ci/cc}$ )

## ENVIRONMENTAL CHARACTERISTICS

- Normal temperature: +5 °C to +40 °C (+41 °F to +104 °F)
- Temperature limit: -5 °C to +55 °C (+23 °F to +131 °F)
- MTBF: > 20 000 hours, with preventive maintenance
- TID: 100 Gy ( $10^{+4}$  rad)

## PNEUMATIC CHARACTERISTICS

- Standard flow rate: 35 l/min (1.24 scfm)
- Pressure drop: according to the filter dust loading

## MECHANICAL CHARACTERISTICS

- Dimensions: 864 mm x 725 mm x 440 mm (34 in x 28.5 in x 17.3 in)
- Weight: ~ 220 kg (~ 495 lb)
- Color: gray RAL 7030 (decontaminable paint)
- Inlet tube connection:  $\varnothing$  12 mm OD (1/2 in)
- Outlet tube connection:  $\varnothing$  12 mm OD (1/2 in)

## ELECTRICAL CHARACTERISTICS

- Power supply: 230 Vac – 50 Hz or 120 Vac – 60 Hz
- Data link outputs: one RS232 (LPDU only) and two isolated RS485
- Alarm relays: three SPDT relays
- I/O: two isolated analog outputs and one isolated analog input (0/4-20 mA)

## SIGNALING (APPLICABLE TO LPDU ONLY)

- Alphanumeric display: measurement, status...
- Sound alarm: buzzer 90 dBA at one meter
- Visual alarm: three lights (red, yellow, green)

## REFERENCE STANDARDS

- Nuclear: IEC60761-1 and IEC60761-3
- EMC: 2014/30/EU and 2014/35/EU, IEC61000-6-2 and IEC61000-6-4

## VERSIONS

- 230 Vac or 120 Vac
- Local processing and display unit (LPDU) or local processing unit (LPU)
- With or without dust filter holder
- Pumping unit
- Monitor wall or floor fixing plate

## ACCESSORIES

- Calibration tools
- Software: MASS2™, RAMVISION™, SIMS2™ applications...
- USB converters



**MIRION**  
TECHNOLOGIES

Copyright © 2024 Mirion Technologies, Inc. or its affiliates. All rights reserved. Mirion, the Mirion logo, and other trade names of Mirion products listed herein are registered trademarks or trademarks of Mirion Technologies, Inc. or its affiliates in the United States and other countries. Third party trademarks mentioned are the property of their respective owners.



RAMSYS™

# NGM 204S™

## Seismic Low Range Noble Gas Monitor

Sampling air in discharge stacks, ventilation ducts or working areas. Can withstand seismic conditions.

### DESCRIPTION

The NGM 204S monitor from the RAMSYS product line has been developed to sample air in discharge stacks or ventilation ducts.

The dual silicon diode detector integrated in a 4 π/5 cm lead shielded sample volume guarantees high reliability of the measurements.

The first silicon diode detects the beta/gamma radiation from sample volume and the gamma ambient radiation (background). The second one detects gamma radiation from the sample volume and the gamma ambient radiation. This allows noble gas beta measurement with dynamic gamma compensation by the processing algorithms.

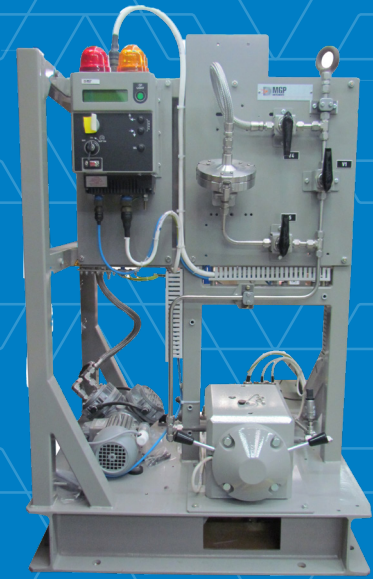

### FEATURES

- ✓ Dynamic gamma radiation compensation
- ✓ Calculation of the total released activity through a stack, when the flow rate signal is provided
- ✓ Compact and reliable
- ✓ 1E qualification and embedded safety related software
- ✓ RG 1.97 compliance
- ✓ Available under 10 CFR 50 App. B, IEC 61226 and ASME NQA-1 programs for safety related application

# NGM 204S™ SEISMIC LOW RANGE NOBLE GAS MONITOR

## PHYSICAL CHARACTERISTICS

- Radiation detected: beta and gamma
- Detector: dual large area silicon
- Sampling chamber: 300 ml (300 cc)
- Typical energy windows:
  - Beta: 80 keV to 2.5 MeV
  - Gamma: 80 keV to 2.5 MeV
- Typical measurement range:
  - $^{85}\text{Kr}$ :  $3.7 \cdot 10^4$  to  $3.7 \cdot 10^{14}$  Bq/m<sup>3</sup> ( $10^{-6}$  to  $10^{+4}$   $\mu\text{Ci/cc}$ )
  - $^{133}\text{Xe}$ :  $3.7 \cdot 10^4$  to  $1.8 \cdot 10^{+13}$  Bq/m<sup>3</sup> ( $10^{-6}$  to  $5 \cdot 10^{+2}$   $\mu\text{Ci/cc}$ )

## ENVIRONMENTAL CHARACTERISTICS

- Normal temperature: +5 °C to +40 °C (+41 °F to +104 °F)
- Temperature limit: -5 °C to +55 °C (+23 °F to +131 °F)
- MTBF: > 20 000 hours, with preventive maintenance
- TID: 100 Gy ( $10^{+4}$  rad)

## PNEUMATIC CHARACTERISTICS

- Standard flow rate: 35 l/min (1.24 scfm)
- Pressure drop: according to the filter dust loading

## MECHANICAL CHARACTERISTICS

- Dimensions: 1305 mm x 830 mm x 680 mm  
(51.4 in x 32.7 in x 26.8 in)
- Weight: ~ 310 kg (~ 684 lb)
- Color: gray RAL 7030 (decontaminable paint)
- Inlet tube connection:  $\varnothing$  12 mm OD (1/2 in)
- Outlet tube connection:  $\varnothing$  12 mm OD (1/2 in)

## ELECTRICAL CHARACTERISTICS

- Power supply: refer to possible versions
- Data link outputs: one RS232 and two isolated RS485
- Alarm relays: three SPDT relays
- I/O: two isolated analog outputs (0/4-20 mA)

## SIGNALING

- Alphanumeric display: measurement, status...
- Sound alarm: buzzer 90 dBA at 1 meter
- Visual alarm: three lights (red, yellow, green)

## REFERENCE STANDARDS

- Nuclear: IEC60761-1 and IEC60761-3
- Environmental: IEC60780, IEEE323, RG 1.97
- Seismic: IEC60980, IEEE344
- EMC: 2014/30/EU and 2014/35/EU, EPRI 102323, RG1.180, IEC61000-6-2 and IEC61000-6-4

## VERSIONS

- 230 Vac or 230 Vac + 400 Vac 3 $\varnothing$  or 120 Vac + 400 Vac 3 $\varnothing$
- Solenoid check sources
- PIS sampler
- Dust filter holder
- Gas grab sampler ports

## ACCESSORIES

- Calibration tools
- Software: MASS2™, RAMVISION™, SIMS2™ applications...
- USB converters
- Local and remote display units



**MIRION**  
TECHNOLOGIES

Copyright © 2023 Mirion Technologies, Inc. or its affiliates. All rights reserved. Mirion, the Mirion logo, and other trade names of Mirion products listed herein are registered trademarks or trademarks of Mirion Technologies, Inc. or its affiliates in the United States and other countries. Third party trademarks mentioned are the property of their respective owners.



RAMSYS™

# NGM 209M™

## Mobile Low Range Noble Gas Monitor



Monitoring air in working areas, discharge stacks or ventilation ducts.

### DESCRIPTION

The NGM 209M monitor from the RAMSYS product line has been developed to monitor air in working areas, discharge stacks or ventilation ducts.

The dual silicon diode detector integrated in a 4 π/3 cm (4 π/1.18 in) lead shielded sample volume guarantees high reliability of the measurements.

The first silicon diode detects the beta/gamma radiation from sample volume and the gamma ambient radiation (background). The second one detects gamma radiation from the sample volume and the gamma ambient radiation. This allows noble gas beta measurement with dynamic gamma compensation by the processing algorithms.

### FEATURES

- ✓ Dynamic gamma radiation compensation with shielded gas detection sensor
- ✓ Operate as a stand-alone monitor and/or can be integrated in a RAMSYS network using a wireless network (radio modem) or a RS485 serial link

# NGM 209M™ MOBILE LOW RANGE NOBLE GAS MONITOR

## PHYSICAL CHARACTERISTICS

- Radiation detected: beta and gamma
- Energy windows: 80 keV to 420 keV
- Detector: dual large area silicon
- Sampling chamber: 76 ml (76 cc)
- Energy range: 80 keV to 2.5 MeV
- Typical measurement range:
  - $^{85}\text{Kr}$ :  $10^{+3}$  to  $3.7 \cdot 10^{+9}$  Bq/m<sup>3</sup> ( $2.7 \cdot 10^{-8}$  to  $10^{-1}$   $\mu\text{Ci/cc}$ )
  - $^{133}\text{Xe}$ :  $10^{+3}$  to  $10^{+10}$  Bq/m<sup>3</sup> ( $2.7 \cdot 10^{-8}$  to  $2.7 \cdot 10^{-1}$   $\mu\text{Ci/cc}$ )

## ENVIRONMENTAL CHARACTERISTICS

- Normal temperature: +5 °C to +40 °C (+41 °F to +104 °F)
- MTBF: > 20 000 hours, with preventive maintenance
- TID: 100 Gy ( $10^{+4}$  rad)

## PNEUMATIC CHARACTERISTICS

- Standard flow rate: 27 l/min (0.95 scfm)
- Pressure drop: according to the filter dust loading

## MECHANICAL CHARACTERISTICS

- Dimensions: 1270 mm x 360 mm x 303 mm  
(50 in x 14.2 in x 12 in)
- Weight: ~ 30 kg (~ 66 lb)
- Color: gray RAL 7030 (decontaminable paint)

## ELECTRICAL CHARACTERISTICS

- Power supply: 230 Vac – 50 Hz or 120 Vac – 60 Hz
- Data link outputs: one RS232 and two isolated RS485
- Alarm relays: three SPDT relays
- I/O: two isolated analog outputs (0/4-20 mA)

## SIGNALING

- Alphanumeric display: measurement, status...
- Sound alarm: buzzer 90 dBA at 1 meter
- Visual alarm: three lights (red, yellow, green)

## REFERENCE STANDARDS

- Nuclear: IEC60761-1 and IEC60761-3
- EMC: 2014/30/EU and 2014/35/EU, IEC61000-6-2 and IEC61000-6-4

## VERSIONS

- 230 Vac or 120 Vac

## ACCESSORIES

- Calibration tools
- Software: MASS2™, RAMVISION™, SIMS2™ applications...
- USB converters
- Remote sampling line with outlet and inlet hoses
- Radio modem



**MIRION**  
TECHNOLOGIES

Copyright © 2023 Mirion Technologies, Inc. or its affiliates. All rights reserved. Mirion, the Mirion logo, and other trade names of Mirion products listed herein are registered trademarks or trademarks of Mirion Technologies, Inc. or its affiliates in the United States and other countries. Third party trademarks mentioned are the property of their respective owners.



RAMSYS™

# NGM 216S™

## Low Range Beta Noble Gas Monitor

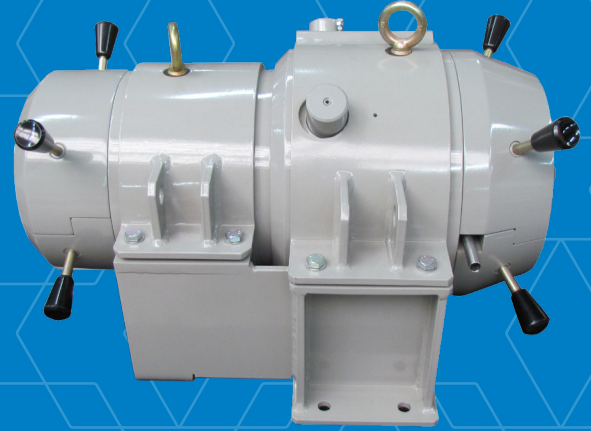

**Continuously measuring beta volumetric activity of radioactive gaseous sample.**

### DESCRIPTION

The NGM 216S monitor from the RAMSYS product line has been developed to continuously measure beta volumetric activity of radioactive gaseous sample.

The sample is drawn from discharge stacks, reactor building, ventilation ducts or working areas via a pumping system. This monitor can operate as a stand alone device or in conjunction with a particulate monitor (PM 205 or ABPM 201), an iodine monitor (IM 201) or a shielded particulate and iodine sampler (PIS 203) and with a high range noble gas monitor (NGM 203) to form a very wide range monitoring system.

### FEATURES

- ✓ Compact and reliable
- ✓ Calculation of the total released activity through a stack flow rate signal provided
- ✓ 1E qualification and embedded safety related software
- ✓ Available under 10 CFR 50 App. B, IEC 61226 and ASME NQA-1 programs for safety related application



# NGM 216S™ LOW RANGE BETA NOBLE GAS MONITOR

## PHYSICAL CHARACTERISTICS

- Radiation detected: beta
- Detector: 2" thin plastic beta scintillator + PMT + embedded LED (SB 70)
- Lead shield: 4 π/7.5 cm (4 π/3 in)
- Typical energy range: > 30 keV
- Typical measurement range: 3.7 10<sup>+3</sup> to 3.7 10<sup>+9</sup> Bq/m<sup>3</sup> (10<sup>-7</sup> to 10<sup>-1</sup> μCi/cc)

## ENVIRONMENTAL CHARACTERISTICS

- Normal temperature: +5 °C to +40 °C (+41 °F to +104 °F)
- Temperature limit:
  - Processing unit: -5 °C to +55 °C (+23 °F to +131 °F)
  - Detector: +0 °C to +60 °C (+32 °F to +140 °F)
- MTBF:
  - Processing unit: > 50 000 hours
  - Detector: > 20 000 hours, with preventive maintenance
- TID: 100 Gy (10<sup>+4</sup> rad)
- Protection index: IP65 and IK07

## PNEUMATIC CHARACTERISTICS

- Standard flow rate: 28.3 l/min (1 scfm)
- Pressure drop: 50 mbar (0.73 psi)

## MECHANICAL CHARACTERISTICS

- Dimensions:
  - Processing unit: 390 mm x 196 mm x 187 mm (15.3 in x 7.7 in x 7.3 in)
  - Detector: 250 mm (10 in) x Ø 72 mm (2.8 in)
- Weight:
  - Processing unit: 4.5 kg or 7 kg (10 lb or 15.5 lb)
  - Detector: ~ 300 kg (661 lb)
- Color: gray RAL 7030 (decontaminable paint)
- Inlet tube connection: Ø 12 mm OD (1/2 in)
- Outlet tube connection: Ø 12 mm OD (1/2 in)

## ELECTRICAL CHARACTERISTICS

- Power supply: 230 Vac – 50 Hz or 120 Vac – 60 Hz
- Data link outputs: one RS232 and two isolated RS485
- Alarm relays: three SPDT relays
- I/O: two isolated analog outputs (0/4-20 mA)
- Embedded LED tester

## SIGNALING (Applicable to LPDU only)

- Alphanumeric display: measurement, status...
- Sound alarm: buzzer 90 dBA at 1 meter
- Visual alarm: three lights (red, yellow, green)

## REFERENCE STANDARDS

- Nuclear: IEC 60761-1 and IEC 60761-3
- Environmental: IEC/IEEE 60780-323
- Seismic: IEC 60980, IEEE 344
- EMC: 2014/30/EU and 2014/35/EU, EPRI 102323,
- MIL STD 461, IEC 61000-6-2 and IEC 61000-6-4

## VERSIONS

- 230 Vac or 120 Vac
- Local processing and display unit (LPDU) or local processing unit (LPU)
- With or without check source
- With or without heater
- PIS sampler
- Dust filter holder

## ACCESSORIES

- Calibration tools
- Software: MASS2™, RAMVISION™, SIMS2™ applications...
- USB converters
- Ethernet (LPDU version only)





RAMSYS™

# PING 206S™

## Seismic Particulate, Iodine and Noble Gas Monitor

Continuously measuring the particulate, iodine and noble gas volumetric activities in stacks, ventilation ducts or working areas. Can withstand seismic conditions. Allows dynamic compensation of radon and thoron progenies.

### DESCRIPTION

The PING 206S monitor forms part of the RAMSYS product line.

It has been developed to continuously measure the particulate, iodine and noble gas volumetric activities in stacks, ventilation ducts or working areas.

The PING 206S monitor integrates all the functions and performances of the ABPM 201, IM 201 and NGM 204 monitors into a single system.

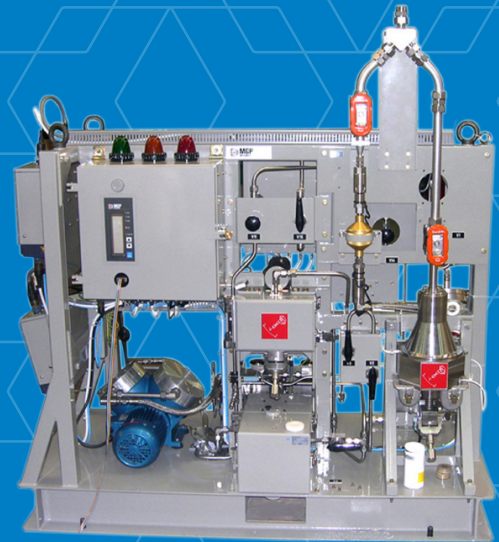

### FEATURES

- ✓ Particulate monitoring with static and dynamic compensation of the radon and thoron solid progenies
- ✓ Iodine monitoring for both molecular and organic forms
- ✓ Noble gas monitoring with dynamic gamma and pressure compensations
- ✓ Local Display Unit (LDU) to display the measurements and status of each channel
- ✓ Compact skid
- ✓ 1E qualification and embedded safety related software
- ✓ Available under 10 CFR 50 App.B, ASME NQA-1 and IEC 61226 programs for safety related applications

# PING 206S™ SEISMIC PARTICULATE, IODINE AND NOBLE GAS MONITOR

## PHYSICAL CHARACTERISTICS

### Particulate (ABPM 201):

- Radiation detected: alpha, beta and gamma
- Detector: dual large area silicon (PIPS® detector)
- Filter type: FSLW
- Typical energy windows:
  - Alpha: 2 MeV to 10 MeV
  - Beta: 80 keV to 2.5 MeV
  - Gamma: 80 keV to 2.5 MeV
- Typical measurement range:
  - Alpha:  $10^{-2}$  to  $3.7 \cdot 10^{+6}$  Bq/m<sup>3</sup> ( $2.7 \cdot 10^{-13}$  to  $10^{-4}$  µCi/cc)
  - Beta: 1 to  $3.7 \cdot 10^{+6}$  Bq/m<sup>3</sup> ( $2.7 \cdot 10^{-11}$  to  $10^{-4}$  µCi/cc)

### Iodine (IM 201):

- Radiation detected: gamma
- Detector: 1¼"x1" NaI(Tl) scintillator + PMT (SG/NAI 1¼"x1")
- Iodine cartridge: 57.7 mm (2.27 in)
- Energy range: 100 keV to 3 MeV
- Typical energy window: 314 - 414 keV (131I, E<sub>γ</sub> 364.5 keV)
- 1024-channel spectrum
- Typical measurement range: 3.7 to  $3.7 \cdot 10^{+6}$  Bq/m<sup>3</sup> ( $10^{-10}$  to  $10^{-4}$  µCi/cc)

### Noble gas (NGM 204):

- Radiation detected: beta and gamma
- Detector: dual large area silicon (PIPS detector)
- Sampling chamber: 300 ml (300 cc)
- Typical energy windows:
  - Beta: 80 keV to 2.5 MeV
  - Gamma: 80 keV to 2.5 MeV
- Typical measurement range:
  - <sup>85</sup>Kr:  $3.7 \cdot 10^{+4}$  to  $3.7 \cdot 10^{+14}$  Bq/m<sup>3</sup> ( $10^{-6}$  to  $10^{+4}$  µCi/cc)
  - <sup>133</sup>Xe:  $3.7 \cdot 10^{+4}$  to  $1.8 \cdot 10^{+13}$  Bq/m<sup>3</sup> ( $10^{-6}$  to  $5 \cdot 10^{+2}$  µCi/cc)

## ENVIRONMENTAL CHARACTERISTICS

- Normal temperature: +5 °C to +40 °C (+41 °F to +104 °F)
- Temperature limit: -5 °C to +55 °C (+23 °F to +131 °F)
- MTBF: > 20 000 hours, with preventive maintenance
- TID: 100 Gy ( $10^{+4}$  rad)

## PNEUMATIC CHARACTERISTICS

- Standard flow rate: 35 l/min (1.24 scfm)
- Pressure drop: 100 to 350 mbar (1.45 to 5.07 psi)

## MECHANICAL CHARACTERISTICS

- Dimensions (with PIS): 1614 mm x 1535 mm x 690 mm (63.5 in x 60.4 in x 27.1 in)
- Weight: between 690 kg (1521 lb) and 720 kg (1587 lb)
- Color: gray RAL 7030 (decontaminable paint)
- Inlet tube connection: Ø 25.4 mm OD (1 in)
- Outlet tube connection: Ø 12 mm OD (1/2 in)

## ELECTRICAL CHARACTERISTICS

- Power supply: refer to possible versions
- Data link outputs: one RS232 and five isolated RS485
- Alarm relays: nine SPDT relays and five DPDT relays
- I/O: eight isolated analog outputs and four isolated analog inputs (0/4-20 mA)

## SIGNALING (ON LDU)

- Graphic display: measurement, historical trend, status...
- Sound alarm: buzzer 90 dBA at 1 meter
- Visual alarm: three lights (red, yellow, green)

## REFERENCE STANDARDS

- Nuclear: IEC 60761-1-2-3-4
- Environmental: RG 1.97, IEC/IEEE 60780-323
- Seismic: IEC 60980, IEEE 344
- EMC: 2014/30/EU and 2014/35/EU, EPRI 102323, RG 1.180, IEC 61000-6-2 and IEC 61000-6-4

## VERSIONS

- 230 Vac or 230 Vac + 400 Vac 3Ø or 120 Vac + 400 Vac 3Ø
- Solenoid check sources for ABPM 201, IM 201, NGM 204 monitors
- PIS particulate and iodine samplers
- Gas grab sampler ports
- Second pump for redundancy

## ACCESSORIES

- Remote display units
- Calibration tools
- Software: MASS2™, RAMVISION™, SIMS2™ applications...
- USB converters

## OPTION: TRITIUM SAMPLER



The HT ionix is designed for monitoring levels of concentration of atmospheric tritium HTO (vapour) form and HT (gas), (available in two or four bottles)



Copyright © 2023 Mirion Technologies, Inc. or its affiliates. All rights reserved. Mirion, the Mirion logo, and other trade names of Mirion products listed herein are registered trademarks or trademarks of Mirion Technologies, Inc. or its affiliates in the United States and other countries. Third party trademarks mentioned are the property of their respective owners.



RAMSYS™

# PIM 206S™

## Seismic Particulate and Iodine Monitor

Continuously measuring particulate and iodine volumetric activities in stacks, ventilation ducts or working areas. Can withstand seismic conditions.

### DESCRIPTION

The PIM 206S monitor forms part of the RAMSYS product line.

It has been developed to continuously measure the particulate and iodine volumetric activities in stacks, ventilation ducts or working areas.

It integrates all the functions and performances of the ABPM 201 and IM 201 monitors into a single monitor.

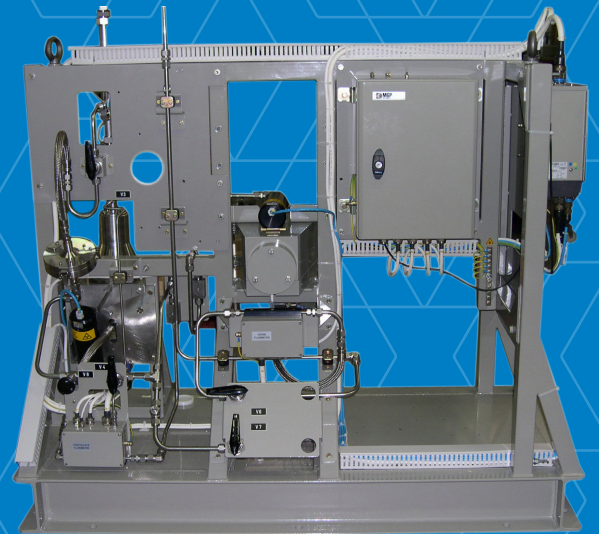

### FEATURES

- ✓ Particulate monitoring with static and dynamic compensation of the radon and thoron solid progenies
- ✓ Iodine monitoring for both molecular and organic forms
- ✓ 1E qualification and embedded safety related software
- ✓ Available under 10 CFR 50 App.B, ASME NQA-1 and IEC 61226 programs for safety related applications

# PIM 206S™ SEISMIC PARTICULATE AND IODINE MONITOR

## PHYSICAL CHARACTERISTICS

### Particulate (ABPM 201):

- Radiation detected: alpha, beta and gamma
- Detector: dual large area silicon (PIPS® detector)
- Filter type: FSLW
- Typical energy windows:
  - Alpha: 2 MeV to 10 MeV
  - Beta: 80 keV to 2.5 MeV
  - Gamma: 80 keV to 2.5 MeV
- Typical measurement range:
  - Alpha:  $10^{-2}$  to  $3.7 \cdot 10^{+6}$  Bq/m<sup>3</sup> ( $2.7 \cdot 10^{-13}$  to  $10^{-4}$  µCi/cc)
  - Beta: 1 to  $3.7 \cdot 10^{+6}$  Bq/m<sup>3</sup> ( $2.7 \cdot 10^{-11}$  to  $10^{-4}$  µCi/cc)

### Iodine (IM 201):

- Radiation detected: gamma
- Detector: 1¼"x1" NaI(Tl) scintillator + PMT (SG/NAI 1¼"x1")
- Iodine cartridge: 57.7 mm (2.27 in)
- Energy range: 100 keV to 3 MeV
- Typical energy window: 314 - 414 keV (131I, E<sub>γ</sub> 364.5 keV)
- 1024-channel spectrum
- Typical measurement range: 3.7 to  $3.7 \cdot 10^{+6}$  Bq/m<sup>3</sup> ( $10^{-10}$  to  $10^{-4}$  µCi/cc)

## ENVIRONMENTAL CHARACTERISTICS

- Normal temperature: +5 °C to +40 °C (+41 °F to +104 °F)
- Temperature limit: -5 °C to +55 °C (+23 °F to +131 °F)
- MTBF: > 20 000 hours, with preventive maintenance
- TID: 100 Gy ( $10^{+4}$  rad)

## PNEUMATIC CHARACTERISTICS

- Standard flow rate: 35 l/min (1.24 scfm)
- Pressure drop: 100 to 350 mbar (1.45 to 5.07 psi)

## MECHANICAL CHARACTERISTICS

- Dimensions: 1607 mm x 1370 mm x 1535 mm (63.2 in x 53.9 in x 60.4 in)
- Weight: 720 kg (1587 lb)
- Inlet tube connection: Ø 25.4 mm OD (1 in)
- Outlet tube connection: Ø 12 mm OD (1/2 in)

## ELECTRICAL CHARACTERISTICS

- Power supply: refer to possible versions
- Data link outputs: one RS232 and five isolated RS485
- Alarm relays: six SPDT relays and five DPDT relays
- I/O: six isolated analog outputs and one isolated analog input (0/4-20 mA)

## SIGNALING

- Graphic display: measurement, historical trend, status...
- Sound alarm: buzzer 90 dBA at 1 meter
- Visual alarm: three lights (red, yellow, green)

## REFERENCE STANDARDS

- Nuclear: IEC 60761, IEC 61171, IEC 61172, IEC 61578
- Environmental: RG 1.97, IEC/IEEE 60780-323
- Seismic: IEC 60980, IEEE 344
- EMC: 2014/30/EU and 2014/35/EU, EPRI 102323, RG 1.180, IEC 61000-6-2 and IEC 61000-6-4

## VERSIONS

- 230 Vac or 230 Vac + 400 Vac 3Ø or 120 Vac + 400 Vac 3Ø
- Solenoid check sources for ABPM 201 and IM 201 monitors
- PIS particulate and iodine samplers
- Gas grab sampler ports
- Second pump for redundancy

## ACCESSORIES

- Local and remote display units
- Calibration tools
- Software: MASS2™, RAMVISION™, SIMS2™ applications...
- USB converters



**MIRION**  
TECHNOLOGIES

Copyright © 2024 Mirion Technologies, Inc. or its affiliates. All rights reserved. Mirion, the Mirion logo, and other trade names of Mirion products listed herein are registered trademarks or trademarks of Mirion Technologies, Inc. or its affiliates in the United States and other countries. Third party trademarks mentioned are the property of their respective owners.



RAMSYS™

# PNG 206S™

## Seismic Particulate and Noble Gas Monitor

Continuously measuring the particulate and noble gas volumetric activities in stacks, ventilation ducts or working areas. Can withstand seismic conditions. Allows dynamic compensation of radon and thoron progenies.

### DESCRIPTION

The PNG 206S monitor forms part of the RAMSYS product line.

It has been developed to continuously measure the particulate and noble gas volumetric activities in stacks, ventilation ducts or working areas. It integrates all the functions and performances of the ABPM 201 and NGM 204 monitors into a single monitor.

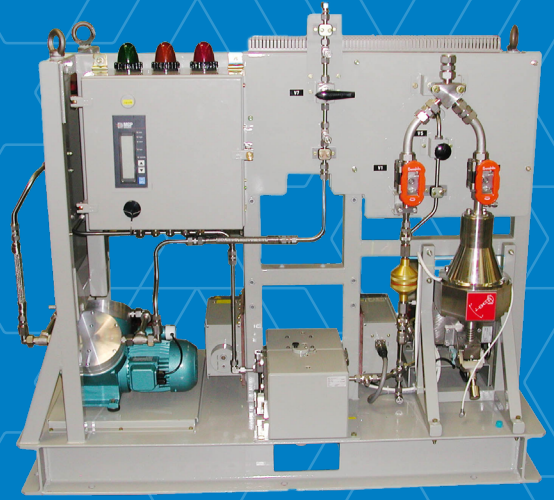

### FEATURES

- ✓ Particulate monitoring with static and dynamic compensation of the radon and thoron solid progenies
- ✓ Noble gas monitoring with dynamic gamma and pressure compensations
- ✓ 1E qualification and embedded safety related software
- ✓ Available under 10 CFR 50 App. B, ASME NQA-1 and IEC 61226 programs for safety related applications

# PNG 206S™ SEISMIC PARTICULATE AND NOBLE GAS MONITOR

## PHYSICAL CHARACTERISTICS

### Particulate (ABPM 201):

- Radiation detected: alpha, beta and gamma
- Detector: dual large area silicon (PIPS® detector)
- Filter type: FSLW
- Typical energy windows:
  - Alpha: 2 MeV to 10 MeV
  - Beta: 80 keV to 2.5 MeV
  - Gamma: 80 keV to 2.5 MeV
- Typical measurement range:
  - Alpha:  $10^{-2}$  to  $3.7 \cdot 10^{+6}$  Bq/m<sup>3</sup> ( $2.7 \cdot 10^{-13}$  to  $10^{-4}$  µCi/cc)
  - Beta: 1 to  $3.7 \cdot 10^{+6}$  Bq/m<sup>3</sup> ( $2.7 \cdot 10^{-11}$  to  $10^{-4}$  µCi/cc)

### Noble gas (NGM 204):

- Radiation detected: beta and gamma
- Detector: dual large area silicon (PIPS detector)
- Sampling chamber: 300 ml (300 cc)
- Typical energy windows:
  - Beta: 80 keV to 2.5 MeV
  - Gamma: 80 keV to 2.5 MeV
- Typical measurement range:
  - <sup>85</sup>Kr:  $3.7 \cdot 10^{+4}$  to  $3.7 \cdot 10^{+14}$  Bq/m<sup>3</sup> ( $10^{-6}$  to  $10^{+4}$  µCi/cc)
  - <sup>133</sup>Xe:  $3.7 \cdot 10^{+4}$  to  $1.8 \cdot 10^{+13}$  Bq/m<sup>3</sup> ( $10^{-6}$  to  $5 \cdot 10^{+2}$  µCi/cc)

## ENVIRONMENTAL CHARACTERISTICS

- Normal temperature: +5 °C to +40 °C (+41 °F to +104 °F)
- Temperature limit: -5 °C to +55 °C (+23 °F to +131 °F)
- MTBF: > 20 000 hours, with preventive maintenance
- TID: 100 Gy ( $10^{+4}$  rad)

## PNEUMATIC CHARACTERISTICS

- Standard flow rate: 35 l/min (1.24 scfm)
- Pressure drop: 100 to 350 mbar (1.45 to 5.07 psi)

## MECHANICAL CHARACTERISTICS

- Dimensions: 1614 mm x 1535 mm x 690 mm (63.5 in x 60.4 in x 27.1 in)
- Weight: between 690 kg (1521 lb) and 720 kg (1587 lb)
- Color: gray RAL 7030 (decontaminable paint)
- Inlet tube connection: Ø 25.4 mm OD (1 in)
- Outlet tube connection: Ø 12 mm OD (1/2 in)

## ELECTRICAL CHARACTERISTICS

- Power supply: refer to possible versions
- Data link outputs: one RS232 and four isolated RS485
- Alarm relays: six SPDT relays and five DPDT relays
- I/O: six isolated analog outputs and one isolated analog input (0/4-20 mA)

## SIGNALING

- Graphic display: measurement, historical trend, status...
- Sound alarm: buzzer 90 dBA at 1 meter
- Visual alarm: three lights (red, yellow, green)

## REFERENCE STANDARDS

- Nuclear: IEC 60761, IEC 611712, IEC 61578
- Environmental: RG 1.97, IEC/IEEE 60780-323
- Seismic: IEC 60980, IEEE 344
- EMC: 2014/30/EU and 2014/35/EU, EPRI 102323, RG 1.180, IEC 61000-6-2 and IEC 61000-6-4

## VERSIONS

- 230 Vac or 230 Vac + 400 Vac 3Ø or 120 Vac + 400 Vac 3Ø
- Solenoid check sources for ABPM 201, NGM 204 monitors
- PIS particulate and iodine samplers
- Gas grab sampler ports
- Second pump for redundancy

## ACCESSORIES

- Local and remote display units
- Calibration tools
- Software: MASS2™, RAMVISION™, SIMS2™ applications...
- USB converters



**MIRION**  
TECHNOLOGIES

Copyright © 2024 Mirion Technologies, Inc. or its affiliates. All rights reserved. Mirion, the Mirion logo, and other trade names of Mirion products listed herein are registered trademarks or trademarks of Mirion Technologies, Inc. or its affiliates in the United States and other countries. Third party trademarks mentioned are the property of their respective owners.



RAMSYS™

# PINGM 207S™

## Seismic Particulate, Iodine and Noble Gas Monitor

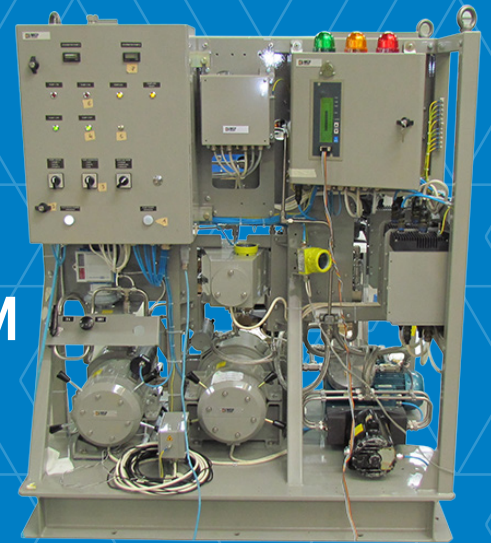

Continuously measuring particulate,  
iodine and noble gas volumetric  
activities.

### DESCRIPTION

The PINGM 207S monitor forms part of the RAMSYS product line. It has been developed to continuously measure the particulate, iodine and noble gas volumetric activities in stacks, ventilation ducts or working areas. It integrates all the functions and performances of the PM 205, IM 201 and NGM 216 monitors into a single monitor.

### FEATURES

- ✓ Compact skid
- ✓ 1E qualification and embedded safety related software
- ✓ Available under 10 CFR 50 App. B, ASME NQA-1 and IEC 61226 programs for safety related applications



# PINGM 207S™ SEISMIC PARTICULATE, IODINE AND NOBLE GAS MONITOR

## PHYSICAL CHARACTERISTICS

### Particulate (PM 205):

- Radiation detected: beta
- Detector: 2" thin plastic scintillator + PMT + embedded LED (SB 70)
- Filter type: fiberglass 49 mm (1.9 in)
- Lead shield: 7.5 cm/4 π (3 in/4 π)
- Typical energy range: > 30 keV
- Typical measurement range: 3.7 10<sup>-2</sup> to 3.7 10<sup>+3</sup> Bq/m<sup>3</sup> (10<sup>-12</sup> to 10<sup>-7</sup> μCi/cc)

### Iodine (IM 201):

- Radiation detected: gamma
- Detector: 1¼"x1" NaI(Tl) scintillator + PMT (SG/NAI 1¼"x1")
- Iodine cartridge: 57.7 mm (2.27 in)
- Energy range: 100 keV to 3 MeV
- Typical energy window: 314 - 414 keV (131I, E<sub>γ</sub> 364.5 keV)
- 1024-channel spectrum
- Typical measurement range: 3.7 to 3.7 10<sup>+6</sup> Bq/m<sup>3</sup> (10<sup>-10</sup> to 10<sup>-4</sup> μCi/cc)

### Noble gas (NGM 216):

- Radiation detected: beta
- Detector: 2" thin plastic beta scintillator + PMT + embedded LED (SB 70)
- Lead shield: 4 π/7.5 cm (4 π/3 in)
- Typical energy range: > 30 keV
- Typical measurement range: 3.7 10<sup>+3</sup> to 3.7 10<sup>+9</sup> Bq/m<sup>3</sup> (10<sup>-7</sup> to 10<sup>-1</sup> μCi/cc)

## ENVIRONMENTAL CHARACTERISTICS

- Normal temperature: +5 °C to +40 °C (+41 °F to +104 °F)
- Temperature limit: -5 °C to +55 °C (+23 °F to +131 °F)
- MTBF: > 20 000 hours, with preventive maintenance
- TID: 100 Gy (10<sup>+4</sup> rad)

## PNEUMATIC CHARACTERISTICS

- Standard flow rate: 28.3 l/min (1 scfm)
- Pressure drop: 50 mbar (0.73 psi)

## MECHANICAL CHARACTERISTICS

- Dimensions:
  - PM 205 detection: 472 x 394 x 385 mm (18.6 x 15.5 x 15 in)
  - IM 201 detection: 380 x 300 x 390 mm (14.9 x 11.8 x 15.3 in)
  - NGM 216 detection: 377 x 572 x 370 mm (14.8 x 22.5 x 14.5 in)
  - LPU processing unit: 346 x 196 x 106 mm (13.6 x 7.7 x 4.2 in)
  - LDU display unit: 507 x 407 x 223 mm (19.9 x 16 x 8.8 in)
- Weight:
  - PM 205 detection: 245 kg (540 lb)
  - IM 201 detection: 125 kg (275 lb)
  - NGM 216 detection: 318 kg (701 lb)
  - LPU processing unit: 6 kg (13 lb)
  - LDU display unit: 6 kg (13 lb)
- Color: gray RAL 7030 (decontaminable paint)
- Inlet tube connection: Ø 25.4 mm OD (1 in)
- Outlet tube connection: Ø 12 mm OD (1/2 in)

## ELECTRICAL CHARACTERISTICS

- Power supply: refer to possible versions
- Data link outputs: one RS232 and five isolated RS485
- Alarm relays: nine SPDT relays and five DPDT relays
- I/O: eight isolated analog outputs and four isolated analog inputs (0/4-20 mA)

## SIGNALING (ON LDU)

- Graphic display: measurement, historical trend, status...
- Sound alarm: buzzer 90 dBA at 1 meter
- Visual alarm: three lights (red, yellow, green)

## REFERENCE STANDARDS

- Nuclear: IEC 60761, IEC 61171, IEC 61172, IEC 61578
- Environmental: IEC/IEEE 60780-323
- Seismic: IEC 60980, IEEE 344
- EMC: 2014/30/EU and 2014/35/EU, EPRI 102323, RG 1.180, IEC 61000-6-2 and IEC 61000-6-4

## VERSIONS

- 230 Vac or 230 Vac + 400 Vac 3Ø or 120 Vac + 400 Vac 3Ø
- Solenoid check sources for PM 205, IM 201, NGM 216
- PIS particulate and iodine samplers
- Second pump for redundancy

## ACCESSORIES

- Remote display units
- Calibration tools
- Software: MASS2™™ RAMVISION™, SIMS2™ applications...
- USB converters





RAMSYS™

# LM 211S™

## Off-line Gamma Liquid Monitor

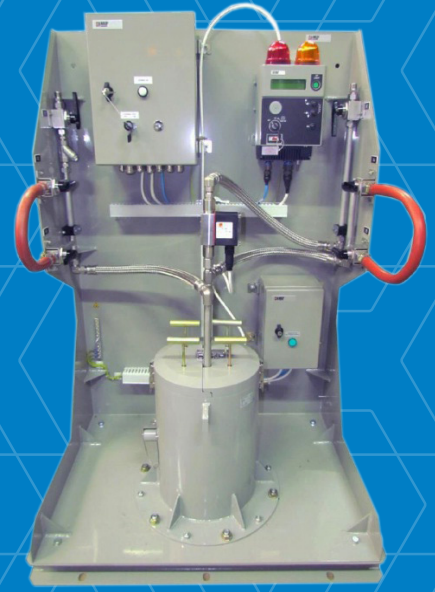

**Sampling liquid from a pipe, a tank or a pool. Can withstand seismic conditions. Version with a  $4\pi$  2" shielding.**

### DESCRIPTION

The LM 211S monitor from the RAMSYS product line has been developed to sample liquid from a pipe, a tank or a pool. A 1¼"x1" NaI scintillation detector faces a liquid sampler inside a  $4\pi$  lead shielding for the gamma emitting isotope monitoring.

A radioactive source  $^{241}\text{Am}$  built into the NaI scintillator allows compensation of potential drift whenever temperature changes occur.

The spectrometry capability, based on a 1024-channel spectrum analysis, allows immediate and easy radio isotope identification in case of alarm.

### FEATURES

- ✓ Energy spectrum and temperature change compensation
- ✓ Available with or without display or local signaling
- ✓ Seismically qualified
- ✓ Available under 10 CFR 50 App.B, ASME NQA-1 and IEC61226 programs for safety related applications

# LM 211S™ OFF-LINE GAMMA LIQUID MONITOR

## PHYSICAL CHARACTERISTICS

- Radiation detected: gamma
- Detector: 1¼" x1" NaI(Tl) scintillator + PMT with <sup>241</sup>Am source (SG/NAI 1¼"x1")
- Lead thickness: 4 π/5 cm (4 π/2 in)
- Energy range: 100 keV to 2.5 MeV
- Measurement range: 3.7 10<sup>+3</sup> to 3.7 10<sup>+9</sup> Bq/m<sup>3</sup> (10<sup>-7</sup> to 10<sup>-1</sup> μCi/cc)

## ENVIRONMENTAL CHARACTERISTICS

- Normal temperature: +5 °C to +40 °C (+41 °F to +104 °F)
- Temperature limit: -5 °C to +55 °C (+23 °F to +131 °F)
- MTBF: > 20 000 hours, with preventive maintenance
- TID:
  - Processing unit: 100 Gy (10<sup>+4</sup> rad)
  - Detector: 100 Gy (10<sup>+4</sup> rad)

## PNEUMATIC CHARACTERISTICS

- Standard flow rate: 10 l/min (0.57 scfm)
- Beaker volume: 4.3 l

## MECHANICAL CHARACTERISTICS

- Dimensions (detection subassembly): 1002 mm (39.4 in) x Ø 478 mm (18.8 in)
- Weight (detection subassembly): ~ 300 kg (~ 661 lb)
- Color: gray RAL 7030 (decontaminable paint)

## ELECTRICAL CHARACTERISTICS

- Power supply: refer to possible versions
- Data link outputs: one RS232 (LPDU only) and two isolated RS485
- Alarm relays: three SPDT relays
- I/O: two isolated analog outputs and one isolated analog input (0/4-20 mA)

## SIGNALING (APPLICABLE TO LPDU ONLY)

- Alphanumeric display: measurement, status...
- Sound alarm: buzzer 90 dBA at 1 meter
- Visual alarm: three lights (red, yellow, green)

## REFERENCE STANDARDS

- Nuclear: IEC60861
- Environmental: IEC/IEEE 60780-323
- Seismic: IEC60980, IEEE344
- EMC: 2014/30/EU and 2014/35/EU, EPRI 102323, RG 1.180, IEC61000-6-2 and IEC61000-6-4

## VERSIONS

- 230 Vac or 230 Vac + 400 Vac 3Ø or 120 Vac + 400 Vac 3Ø
- Local processing and display unit (LPDU) or local processing unit (LPU)
- Valve plate
- Pumping system

## ACCESSORIES

- Calibration tools
- Software: MASS2™, RAMVISION™, SIMS2™ applications...
- USB converters
- Seismic qualified wall mounting bracket for LP(D)U



**MIRION**  
TECHNOLOGIES

Copyright © 2024 Mirion Technologies, Inc. or its affiliates. All rights reserved. Mirion, the Mirion logo, and other trade names of Mirion products listed herein are registered trademarks or trademarks of Mirion Technologies, Inc. or its affiliates in the United States and other countries. Third party trademarks mentioned are the property of their respective owners.



RAMSYS™

# LM 212S™

## Off-line Gamma Liquid Monitor



**Sampling liquid from a pipe, a tank or a pool. Can withstand seismic conditions. Version with a 4 π 4" shielding.**

### DESCRIPTION

The LM 212S monitor from the RAMSYS product line has been developed to sample liquid from a pipe, a tank or a pool. A 1¼"x1" NaI scintillation detector faces a liquid sampler inside a 4 π lead shielding for the gamma emitting isotope monitoring.

A radioactive source <sup>241</sup>Am built into the NaI scintillator allows compensation of potential drift whenever temperature changes occur.

The spectrometry capability, based on a 1024-channel spectrum analysis, allows immediate and easy radio isotope identification in case of alarm.

### FEATURES

- ✓ Energy spectrum and temperature change compensation
- ✓ Available with or without display or local signaling
- ✓ Seismically qualified
- ✓ The hinge mounted cover of the lead shielding makes maintenance easier on the detector
- ✓ Available under 10 CFR 50 App.B, ASME NQA-1 and IEC 61226 programs for safety related applications

# LM 212S™ OFF-LINE GAMMA LIQUID MONITOR

## PHYSICAL CHARACTERISTICS

- Radiation detected: gamma
- Detector: 1¼" x1" NaI(Tl) scintillator + PMT with <sup>241</sup>Am source (SG/NAI 1¼"x1")
- Lead thickness: 4 π/10 cm (4 π/4 in)
- Energy range: 100 keV to 2.5 MeV
- Measurement range: 3.7 10<sup>+3</sup> to 3.7 10<sup>+9</sup> Bq/m<sup>3</sup> (10<sup>-7</sup> to 10<sup>-1</sup> μCi/cc)

## ENVIRONMENTAL CHARACTERISTICS

- Normal temperature: +5 °C to +40 °C (+41 °F to +104 °F)
- Temperature limit: -5 °C to +55 °C (+23 °F to +131 °F)
- MTBF: > 20 000 hours, with preventive maintenance
- TID:
  - Processing unit: 100 Gy (10<sup>+4</sup> rad)
  - Detector: 100 Gy (10<sup>+4</sup> rad)

## PNEUMATIC CHARACTERISTICS

- Standard flow rate: 10 l/min (0.57 scfm)
- Beaker volume: 4.3 l

## MECHANICAL CHARACTERISTICS

- Dimensions (detection subassembly): 1052 mm (41.4 in) x Ø 514 mm (20.2 in)
- Weight (detection subassembly): ~ 735 kg (~ 1617 lb)
- Color: gray RAL 7030 (decontaminable paint)

## ELECTRICAL CHARACTERISTICS

- Power supply: refer to possible versions
- Data link outputs: one RS232 (LPDU only) and two isolated RS485
- Alarm relays: three SPDT relays
- I/O: two isolated analog outputs and one isolated analog input (0/4-20 mA)

## SIGNALING (APPLICABLE TO LPDU ONLY)

- Alphanumeric display: measurement, status...
- Sound alarm: buzzer 90 dBA at 1 meter
- Visual alarm: three lights (red, yellow, green)

## REFERENCE STANDARDS

- Nuclear: IEC 60861
- Environmental: IEC/IEEE 60780-323
- Seismic: IEC 60980, IEEE 344
- EMC: 2014/30/EU and 2014/35/EU, EPRI 102323, RG 1.180, IEC 61000-6-2 and IEC 61000-6-4

## VERSIONS

- 230 Vac or 230 Vac + 400 Vac 3Ø or 120 Vac + 400 Vac 3Ø
- Local processing and display unit (LPDU) or local processing unit (LPU)
- Valve plate
- Pumping system

## ACCESSORIES

- Calibration tools
- Software: MASS2™, RAMVISION™, SIMS2™ applications...
- USB converters
- Seismic qualified wall mounting bracket for LP(D)U



**MIRION**  
TECHNOLOGIES

Copyright © 2023 Mirion Technologies, Inc. or its affiliates. All rights reserved. Mirion, the Mirion logo, and other trade names of Mirion products listed herein are registered trademarks or trademarks of Mirion Technologies, Inc. or its affiliates in the United States and other countries. Third party trademarks mentioned are the property of their respective owners.



RAMSYS™

# PIS 203S™

## Shielded Particulate and Iodine Sampler

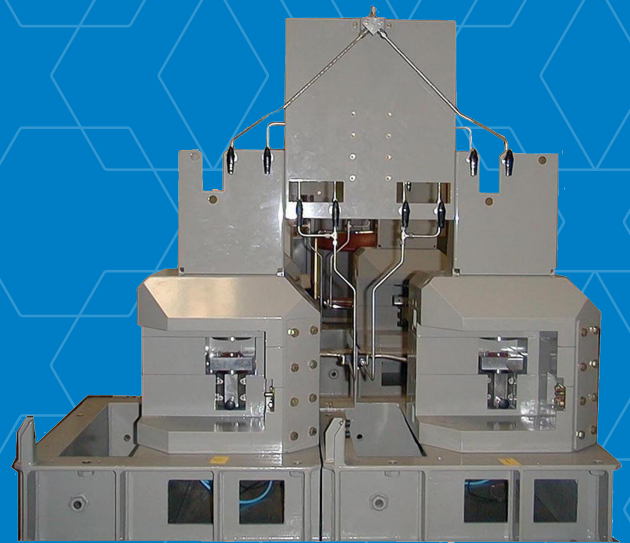

**Sampling air effluents under accident conditions. Shielded for ALARA purposes and for use under accident conditions and with dual unit capability.**

### DESCRIPTION

The PIS 203S sampler forms part of the RAMSYS product line. It has been developed to sample air effluents under accident conditions conforming to the requirements set forth by RG 1.97. One sampler for batch sampling or dual samplers for continuous sampling are available with or without heat tracing. The sample flow rate through the sampler is measured and totalized. The collected activities of particulates and iodine are periodically analyzed in a laboratory as needed.

The PIS 203S is typically used in conjunction with noble gas monitor (NGM 203 and NGM 204) and an aerualic skid that automatically control the operation from standby to active sampling as applicable.

### FEATURES

- ✓ Available for batch or continuous sampling acquisition version (single or dual PIS 203S units)
- ✓ Automatic start up in accident configuration
- ✓ Heat tracing available when required
- ✓ Provided with manipulation tools and lead shielded transport cart
- ✓ Heavily shielded for ALARA radiation considerations
- ✓ Available under 10 CFR 50 App. B, ASME NQA-1 programs for safety related application

# PIS 203S™ SHIELDED PARTICULATE AND IODINE SAMPLER

## PHYSICAL CHARACTERISTICS

- Particulate:
  - Filter type: fiberglass
  - Efficiency: > 99.95%
- Iodine:
  - Cartridge type: silver zeolite
  - Efficiency: > 99.99% (for methyl iodide)
- Lead shielding: 4 π/15 cm (4 π/5.9 in)
- Concentration on filter: 3.7 10<sup>+7</sup> to 3.7 10<sup>+12</sup> Bq/m<sup>3</sup> (10<sup>-3</sup> to 10<sup>+2</sup> μci/cc)

## ENVIRONMENTAL CHARACTERISTICS

- Normal temperature: +5 °C to +40 °C (+41 °F to +104 °F)
- Temperature limit: -5 °C to +55 °C (+23 °F to +131 °F)
- Pressure: 860 to 1060 hPa

## PNEUMATIC CHARACTERISTICS

- Standard flow rate: 1 l/min

## MECHANICAL CHARACTERISTICS

- Dimensions: 1214 mm x 650 mm x 740 mm (48 in x 25.6 in x 29.1 in)
- Weight: ~ 750 kg (~ 1650 lb)
- Color: gray RAL 7030 (decontaminable paint)
- Inlet tube connection: Ø 6.3 mm OD (1/4 in)
- Outlet tube connection: Ø 6.3 mm OD (1/4 in)

## ELECTRICAL CHARACTERISTICS

- Power supply: refer to possible versions

## REFERENCE STANDARDS

- Environmental: RG 1.97
- EMC: 2014/30/EU and 2014/35/EU

## VERSIONS

- 230 Vac or 230 Vac + 400 Vac 3Ø or 120 Vac + 400 Vac 3Ø
- Single module or dual unit
- Heat tracing with heat control unit, temperature sensors, thermal insulation and heating cartridge

## ACCESSORIES

- Shielded transport cart
- Sampling handling tool
- Filter paper
- Silver zeolite cartridge
- P/I holder



**MIRION**  
TECHNOLOGIES

Copyright © 2024 Mirion Technologies, Inc. or its affiliates. All rights reserved. Mirion, the Mirion logo, and other trade names of Mirion products listed herein are registered trademarks or trademarks of Mirion Technologies, Inc. or its affiliates in the United States and other countries. Third party trademarks mentioned are the property of their respective owners.



RAMSYS™

# PIS 204L™

## Particulate and/or Iodine Sampler

Sampling air from effluent stacks, ventilation ducts or working areas. Version with manual flow rate control.

### DESCRIPTION

The PIS 204L forms part of the RAMSYS product line.

It has been developed to continuously sample draw of particulate and iodine, in both molecular and organic forms (methyl iodide), in air from effluent stacks, ventilation ducts and/or working areas, in a mild environment.

The nominal flow rate for this sampler is adjusted via a manual valve without automatic control. The radioactive particulate trapped on designated paper filter can be submitted to laboratory analysis specific tests as: qualitative analysis (spectrographic or chemical) to identify the isotopes, quantitative analysis using reflectometer, measurement of particulate radioactivity.



### FEATURES

- ✓ Compact and integrated unit
- ✓ Manual flow rate control
- ✓ Network capability



# PIS 204L™ PARTICULATE AND/OR IODINE SAMPLER

## PHYSICAL CHARACTERISTICS

- Particulate:
  - Filter type: FSLW or equivalent Ø 47 to 57 mm (1.8 to 2.2 in)
- Iodine:
  - Cartridge type: silver zeolite or active charcoal
  - Efficiency: > 99% for methyl iodide (HR 60%)
- Filter/cartridge change frequency: one per week if continuous trapping

## ENVIRONMENTAL CHARACTERISTICS

- Normal temperature: 0 °C to +40 °C (+32 °F to +104 °F)
- Temperature limit: 0 °C to +45 °C (+32 °F to +113 °F)
- Storage temperature (during 96 hours): -25 °C to +85 °C (-13 °F to +185 °F)
- Pressure: 860 to 1060 hPa
- MTBF: > 20 000 hours, with preventive maintenance
- Protection index: IP32

## PNEUMATIC CHARACTERISTICS

- Nominal flow rate:
  - By default: 35 l/min (1.25 scfm)
  - Minimum: 10 l/min (0.36 scfm)
  - Maximum: 50 l/min (1.79 scfm)

## MECHANICAL CHARACTERISTICS

- Dimensions: 762 mm (with 1 cartridge) or 800 mm (with 2 cartridges) x 435 mm x 198 mm (30 in or 31.5 in x 17.1 in x 7.8 in)
- Weight: ~ 19 kg (~ 42 lb)
- Color: gray RAL 7030 (decontaminable paint)
- Outlet tube connection: Ø 6.3 mm OD (1/4 in)

## ELECTRICAL CHARACTERISTICS

- Power supply: 230 Vac - 50 Hz or 120 Vac - 60 Hz
- Data link outputs: 1 RS232 on DB9 connector on front panel and 2 isolated RS485 via cable glands
- Alarm relays: 3 DPDT relays

## SIGNALING

- Alphanumeric display: measurement, status...
- Sound alarm: buzzer 90 dBA at 1 meter
- Visual alarm: 1 light (red)

## REFERENCE STANDARDS

- EMC: 2014/30/EU and 2014/35/EU, IEC 61000-6-2 and IEC 61000-6-4

## VERSIONS

- 230 Vac or 120 Vac

## ACCESSORIES

- Maintenance and set-up software (MASS2)
- Wall installation
- FSLW filter or equivalent
- Zeolite or charcoal cartridge
- MODBUS/TCP
- Material to adapt to each sheath: isokinetic sampling



**MIRION**  
TECHNOLOGIES

Copyright © 2024 Mirion Technologies, Inc. or its affiliates. All rights reserved. Mirion, the Mirion logo, and other trade names of Mirion products listed herein are registered trademarks or trademarks of Mirion Technologies, Inc. or its affiliates in the United States and other countries. Third party trademarks mentioned are the property of their respective owners.



RAMSYS™

# PIS 205L™

## Particulate and/or Iodine Sampler



Sampling air from effluent stacks, ventilation ducts or working areas. Specially adapted for stack or duct when an isokinetic sampling is required.

### DESCRIPTION

The PIS 205L sampler forms part of the RAMSYS product line.

It has been developed to continuously sample draw of particulate and iodine, in both molecular and organic forms (methyl iodide), in air from effluent stacks, ventilation ducts and/or working areas, in a mild environment.

This version is specially adapted for stack or duct when an isokinetic sampling is required. The radioactive particulate trapped on designated paper filter can be submitted to laboratory analysis specific tests as: qualitative analysis (spectrographic or chemical) to identify the isotopes, quantitative analysis using reflectometer, measurement of particulate radioactivity.

### FEATURES

- ✓ Compact and integrated unit
- ✓ Dynamic flow rate control
- ✓ Isokinetic sampling flow rate control
- ✓ Network capability

# PIS 205L™ PARTICULATE AND/OR IODINE SAMPLER

## PHYSICAL CHARACTERISTICS

- Particulate:
  - Filter type: FSLW or equivalent Ø 47 to 57 mm (1.8 to 2.2 in)
- Iodine:
  - Cartridge type: silver zeolite or active charcoal
  - Efficiency: > 99% for methyl iodide (HR 60%)
- Filter/cartridge change frequency: one per week if continuous trapping

## ENVIRONMENTAL CHARACTERISTICS

- Normal temperature: 0 °C to +40 °C (+32 °F to +104 °F)
- Temperature limit: 0 °C to +45 °C (+32 °F to +113 °F)
- Pressure: 860 to 1060 hPa
- MTBF: > 20 000 hours, with preventive maintenance
- Protection index: IP32

## PNEUMATIC CHARACTERISTICS

- Nominal flow rate:
  - By default: 35 l/min (1.25 scfm)
  - Minimum: 10 l/min (0.36 scfm)
  - Maximum: 50 l/min (1.79 scfm)

## MECHANICAL CHARACTERISTICS

- Dimensions: 880 mm (with 1 cartridge) or 932 mm (with 2 cartridges) x 435 mm x 370 mm (34.6 in or 36.6 in x 17.1 in x 14.6 in)
- Weight: ~ 27 kg (~ 59 lb)
- Color: gray RAL 7030 (decontaminable paint)

## ELECTRICAL CHARACTERISTICS

- Power supply: 230 Vac - 50 Hz
- Data link outputs: one RS232 on DB9 connector on front panel and two isolated RS485 via cable glands
- Alarm relays: three DPDT relays
- I/O: one isolated analog output and one isolated analog input (0/4-20 mA)

## SIGNALING

- Alphanumeric display: measurement, status...
- Sound alarm: buzzer 90 dBA at 1 meter
- Visual alarm: one light (red)

## REFERENCE STANDARDS

- EMC: 2014/30/EU and 2014/35/EU, IEC 61000-6-2 and IEC 61000-6-4

## VERSIONS

- 230 Vac or 120 Vac

## ACCESSORIES

- Maintenance and set-up software (MASS2™)
- Wall installation
- FSLW filter or equivalent
- Zeolite cartridge or charcoal cartridge
- Material to adapt to each sheath:
  - Flow rate control
  - Isokinetic sampling



Copyright © 2023 Mirion Technologies, Inc. or its affiliates. All rights reserved. Mirion, the Mirion logo, and other trade names of Mirion products listed herein are registered trademarks or trademarks of Mirion Technologies, Inc. or its affiliates in the United States and other countries. Third party trademarks mentioned are the property of their respective owners.



RAMSYS™

# LP(D)U™

## Local Processing (and Display) Unit



Processing and display of the measurements, alarms and status of the monitors

### DESCRIPTION

The LPU (Local Processing Unit) and the LPDU (Local Processing and Display Unit) form part of the RAMSYS product line.

Compact and reliable, they have been developed to receive, amplify and process the pulses transmitted by the detector, generate the measurement and the alarms, manage the communication with the display units, manages the analog inputs/outputs and fault/alarm relay contacts.

The LP(D)U are available in several versions adapted to different detection principles. It is perfectly compatible with the RAMSYS system (communication with LDU™, RDU™, ADU™ and central PC through an RS485 type link).

### FEATURES

- ✓ Generation of the measurement
- ✓ Storage of the change of this measurement with time
- ✓ Can be connected to the network with an RS485 link
- ✓ Configurable according to needs
- ✓ Simplified maintenance
- ✓ Compact and reliable

## LP(D)U™ LOCAL PROCESSING (AND DISPLAY) UNIT

### ENVIRONMENTAL CHARACTERISTICS

- Operating temperature: +10 °C to +40 °C (+50 °F to +104 °F)
- MTBF: > 50 000 hours
- TID: 100 Gy (10<sup>+4</sup> rad)
- Protection index: IP65 and IK07

### MECHANICAL CHARACTERISTICS

- Dimensions:
  - LPU: 346 mm x 196 mm x 106 mm  
(13.6 in x 7.7 in x 4.2 in)
  - LPDU: 367 mm x 196 mm x 209 mm  
(14.4 in x 7.7 in x 8.2 in)
- Weight:
  - LPU: 6 kg (13 lb)
  - LPDU: 8 kg (17.7 lb)
- Color: gray RAL 7030 (decontaminable paint)

### ELECTRICAL CHARACTERISTICS

- Power supply: 230 Vac – 50 Hz or 120 Vac – 60 Hz
- Data link outputs: one RS232 and two isolated RS485
- Alarm relays: five TOR relays (five optional DPDT relays)
- I/O: two isolated analog outputs and one isolated analog input (0/4-20 mA)

### SIGNALING (APPLICABLE TO LPDU ONLY)

- Alphanumeric display: measurement, status...
- Sound alarm: buzzer 90 dBA at 1 meter, adjustable frequencies
- Visual alarm: 3 lights (red, yellow, green)

### REFERENCE STANDARDS

- EMC: IEC 61000-6-4, IEC 61000-6-2, EN55022

### VERSIONS

- 230 Vac, 120 Vac or 24 Vac
- With or without display
- With or without 800 mAh or 8 Ah battery

### ACCESSORIES

- Software: MASS2™, RAMVISION™ applications...
- Ethernet
- Wall mounting bracket



**MIRION**  
TECHNOLOGIES

Copyright © 2024 Mirion Technologies, Inc. or its affiliates. All rights reserved. Mirion, the Mirion logo, and other trade names of Mirion products listed herein are registered trademarks or trademarks of Mirion Technologies, Inc. or its affiliates in the United States and other countries. Third party trademarks mentioned are the property of their respective owners.



RAMSYS™

# ADU™

## Alarm Display Unit



Display of the measurements, alarms and status of the monitors

### DESCRIPTION

The ADU (Alarm Display Unit) forms part of the RAMSYS product line.

Compact and reliable, it has been developed to display the measurements, alarms and status of the monitors connected (Up to 18 with the same RS485 interface).

Through TOR data, it can also manage visual and sound alarms of the processing units (LPDU) connected with the ADU. Its configuration system allows to adapt the processing unit working with the TOR data types of the monitor.

### FEATURES

- ✓ Can be connected anywhere to the network with the RS485 links
- ✓ Configurable according to needs
- ✓ Simplified maintenance
- ✓ Possible configuration with LP(D)U
- ✓ Ethernet connection
- ✓ Compact and light

## ADU™ ALARM DISPLAY UNIT

### ENVIRONMENTAL CHARACTERISTICS

- Operating temperature: +10 °C to +40 °C (+50 °F to +104 °F)
- MTBF: > 50 000 hours
- TID: 100 Gy (10<sup>+4</sup> rad)
- Protection index: IP65 and IK07

### MECHANICAL CHARACTERISTICS

- Dimensions: 665 mm x 334 mm x 188 mm  
(26.2 in x 13.1 in x 7.4 in)
- Weight: 7.3 kg (16 lb)
- Color: gray RAL 7030 (decontaminable paint)

### ELECTRICAL CHARACTERISTICS

- Power supply: 230 Vac – 50 Hz or 120 Vac – 60 Hz
- Data link outputs: one RS232 and two isolated RS485
- Alarm relays: five TOR relays (five optional DPDT relays)
- I/O: two isolated analog outputs and one isolated analog input (0/4-20 mA)

### SIGNALING

- Alphanumeric display: measurement, status... on a 240 x 64 graphic screen
- Sound alarm: buzzer 90 dBA at one meter, adjustable frequencies
- Visual alarm: three lights (red, yellow, green)
- Optional fourth light (white) for test

### REFERENCE STANDARDS

- EMC: IEC 61000-6-4, IEC 61000-6-2, EN55022

### ACCESSORIES

- Software: MASS2™, RAMVISION™ applications...
- Ethernet
- Wall mounting bracket



**MIRION**  
TECHNOLOGIES

Copyright © 2024 Mirion Technologies, Inc. or its affiliates. All rights reserved. Mirion, the Mirion logo, and other trade names of Mirion products listed herein are registered trademarks or trademarks of Mirion Technologies, Inc. or its affiliates in the United States and other countries. Third party trademarks mentioned are the property of their respective owners.



RAMSYS™

# RDU™

## Remote Display Unit

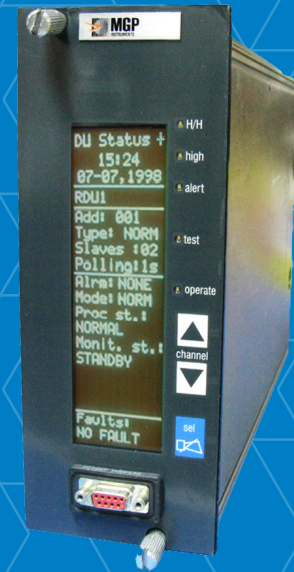

Remote display of the measurements, alarms and status of the RAMSYS monitors.

### DESCRIPTION

The RDU unit forms part of the RAMSYS product line.

The RDU unit provides remote display and remote alarm signaling functions. This rack mounted version reports measurements provided by the LP(D)U processing units into the RAMSYS network.

The RDU unit can generate sound and visual alarms, activate alarm relays according to the operational status of the LP(D)U units. It can transmit operational status to a supervisor or other display units integrated into the RAMSYS network.

### FEATURES

- ✓ Remote display for RAMSYS monitors
- ✓ Alarm reporting for RAMSYS monitors
- ✓ Rugged and reliable
- ✓ Seismic qualification
- ✓ 1E qualification and embedded safety related software
- ✓ Available under 10 CFR 50 App. B, ASME NQA-1 and IEC 61226 programs for safety related application



## RDU™ REMOTE DISPLAY UNIT

### ENVIRONMENTAL CHARACTERISTICS

- Normal temperature: +10 °C to +40 °C (+50 °F to +104 °F)
- Temperature limit: -5 °C to +55 °C (+23 °F to +131 °F)
- MTBF: > 50 000 hours

### MECHANICAL CHARACTERISTICS

- The RDU unit is a rackable unit
- Up to 5 RDU units can be installed in a 5U - 19" chassis
- Dimensions: 220 mm x 320 mm x 85 mm  
(8.6 in x 12.6 in x 3.3 in)
- Weight: 2 kg (4.4 lb)

### ELECTRICAL CHARACTERISTICS

- Power supply: 230 Vac – 50 Hz or 120 Vac – 60 Hz
- Data link outputs: one RS232 and three isolated RS485 (two upstream links, one downstream link)
- Alarm relays: five 2DPT relays (OP, TEST, AL1, AL2, AL3)
- I/O:
  - Two isolated analog outputs and one isolated analog input (0/4-20 mA)
  - Eight digital inputs
  - Eight digital outputs

### SIGNALING

- LCD display: measurements, status...
- Sound alarm: buzzer 64 dBA at 1 meter
- Visual alarm: five signaling LEDs (OP, TEST, AL1, AL2, AL3)

### REFERENCE STANDARDS

- Environmental: IEC/IEEE 60780-323
- Seismic: IEEE 344 and IEC 60980
- EMC: 2014/30/EU and 2014/35/EU, EPRI 102323, RG 1.180, IEC 61000-6-4, IEC 61000-6-2

### VERSIONS

- 230 Vac or 120 Vac

### ACCESSORIES

- Software: MASS2™, RAMVISION™, SIMS2™ applications...
- USB converters



**MIRION**  
TECHNOLOGIES

Copyright © 2024 Mirion Technologies, Inc. or its affiliates. All rights reserved. Mirion, the Mirion logo, and other trade names of Mirion products listed herein are registered trademarks or trademarks of Mirion Technologies, Inc. or its affiliates in the United States and other countries. Third party trademarks mentioned are the property of their respective owners.



RAMSYS™

# MASS2™

## Maintenance and Set-up Software

User friendly interface for setup, configuration, surveillance, maintenance and network display of RAMSYS™ monitors.

### DESCRIPTION

The MASS2 software is a powerful tool to set-up, configure and verify monitors belonging to the RAMSYS product line. It capitalizes each feature of the system and offers many functionalities to aid exploitation of the full capabilities of each monitor.

The MASS2 functionalities were developed based on ten years experience with the RAMSYS system. Moreover it extends the RAMSYS family spectroscopy features by adding powerful spectrum acquisition and manipulation functions of the SAMS™ software. It allows acquisition and analysis of the monitor (with LPU/SAS/NaI, LPU/SAS/NaI/Beta or LPU/SPIPS) in true or live time, total counting, region of interest counting or statistical evolutions.

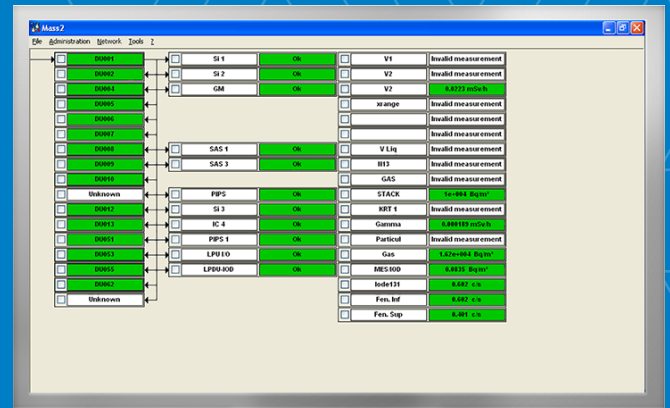

### FEATURES

- ✓ User friendly and ergonomic Microsoft Windows® based interface
- ✓ Display network of connected RAMSYS monitors
- ✓ Right-click instant access to the monitor configuration screens
- ✓ Communication through standard RS232 or RS485 serial link
- ✓ Integration on the site Ethernet network
- ✓ Password protection (multi level)
- ✓ Display of up to 4 spectra curves with associated data simultaneously (for liquid, iodine, N-13, N-16, particulate and gas monitors)
- ✓ Detector adjustment and spectrum energy calibration
- ✓ Treatment functions as smoothing and subtraction

## MASS2™ MAINTENANCE AND SET-UP SOFTWARE

### MAINTENANCE AND SETUP FUNCTIONS

- **Display graphically the network of monitors using one of the selectable modes:**
  - Topology
  - Associations between display and processing monitors
  - List
- Display measurements and statuses with dedicated colors for each state
- Display event summary of the monitor
- Display measurement historical trends
- Set network management (local host or site network)
- Log file management
- **Through pull-down menus and a variety of pre-designed dedicated screens:**
  - Set operational parameters (alarm thresholds, analog outputs, analog input...)
  - Set system parameters (network address, algorithm configuration...)
  - Easy upgrade of the monitor firmware and set of parameters
- **For each configuration screen:**
  - Verify parameter validities automatically before writing on the monitor
  - Secure access and reload the parameters
  - Compare visually saved parameters with the monitor current ones

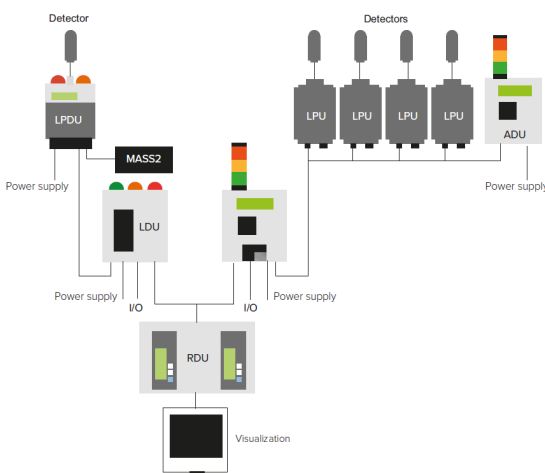

### SECURITY

MASS2 manages four user access levels and allows to create user accounts. High level users may define the visibility access level of each functionality. High level users may also personalize configuration screens by defining read and write access levels for each set of parameters.

### SPECTRUM ACQUISITION AND MANIPULATION FUNCTIONS

For each monitor with spectroscopy features, MASS2 allows to launch the SAMS dedicated software to acquire, visualize and manipulate spectra. The spectrum display window gathers on the same screen all the information the user needs to drive the acquisition. Frequently used functions can be accessed directly through buttons like:

- Select a spectrum's curve to handle and/or to display
- Enter preset value of acquisition time
- Start/stop acquisition
- Clear spectrum
- Zoom in, zoom out, zoom between cursors or display entire spectrum
- Manual/automatic vertical scale
- Lock/free cursor interval (region's width)
- Select, define or clear a region of interest

This software can be used as an operational tool for spectrum acquisition and for detector calibration. It gives extended spectrum diagnosis information as well as rough isotopic discrimination. It is directly connected to the LPU/SAS/NaI, LPU/SAS/NaI/Beta or LPU/SPIPS. SAMS can be used simultaneously with MASS2.

### COMPLEMENTARY FUNCTIONS

MASS2 is multilingual and facilitates addition of new languages by managing easily translatable ASCII text files.



**MIRION**  
TECHNOLOGIES

Copyright © 2024 Mirion Technologies, Inc. or its affiliates. All rights reserved. Mirion, the Mirion logo, and other trade names of Mirion products listed herein are registered trademarks or trademarks of Mirion Technologies, Inc. or its affiliates in the United States and other countries. Third party trademarks mentioned are the property of their respective owners.



RAMSYS™

# RAMVISION™

## Supervisory Control and Data Acquisition Software

User friendly software to acquire, store and provide measurements and status with archiving capabilities.

### DESCRIPTION

The RAMVISION software has been developed to manage acquisition, storage and visualization of the RAMSYS product line monitor measurements.

This software allows monitoring of a medium size RAMSYS compatible network. Its modular architecture makes it opened and able to supervise other data sources (weather stations, other monitor types).

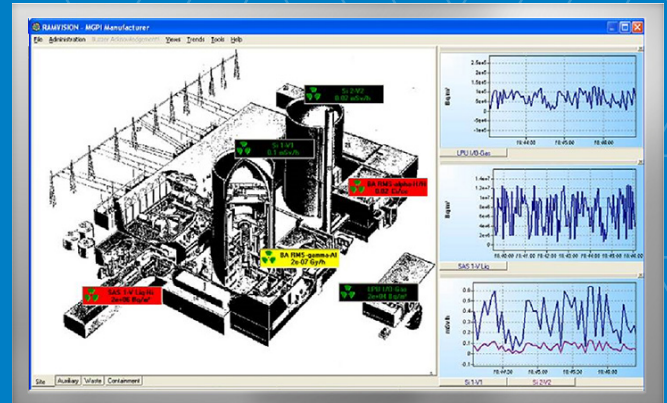

### FEATURES

- ✓ User friendly and ergonomic Microsoft Windows® based interface
- ✓ Graphical display of measurements (trends, grids of cells, cartography)
- ✓ Remote visualization stations
- ✓ Alarm management
- ✓ Histories and daily archives
- ✓ Data export (Excel, database...)
- ✓ Modular, evolutive and opened
- ✓ Based on TCP/IP and a client/server distributed architecture
- ✓ Launch MASS2™

# RAMVISION™ SUPERVISORY CONTROL AND DATA ACQUISITION SOFTWARE

## STANDARD FUNCTIONS

- Security access management (2 levels)
- Periodical acquisition of monitor measurements and status (redundancy possibility)
- Processing historics of instantaneous or averaged data
- Daily archiving of historics
- Fault and alarm thresholds management:
  - Visual alarms (with dedicated colors)
  - Auditory alarms (buzzer)
- Set alarm threshold
- Data real time visualization:
  - Numerical display – cells in view of grid or cartographic style
  - Graphical display – trends
- Set graphically view parameters (cells positioning by drag and drop)
- Historics and archives visualization in batch mode
- Batch mode exportation of historics and archives with picture (WMF, EMF, BMP) or text (CSV for Excel) formats
- Multilingual management with easy translatable text files as inputs
- Log file management

## COMPLEMENTARY FUNCTIONS OPTIONS

- Status report on digital output boards (requires specific hardware)
- Measurement report on analog boards (requires specific hardware)
- Real time exportation of measurements in regular text files, continuously or at change, instantaneous or averaged.
- Real time exportation of measurements to a database (SQL Server, Oracle) using a universal Microsoft ODBC connection
- Interface with a weather station (VAISALA WXT510)
- Interface with non RAMSYS monitors on the market
- Calculation of virtual measurements from real ones

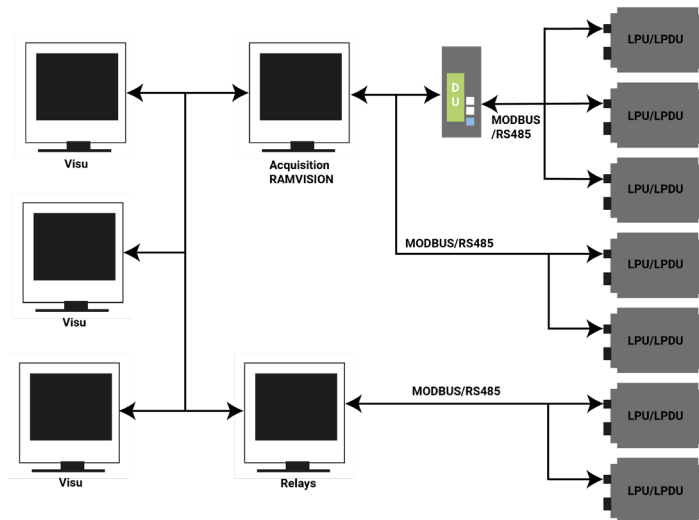

**MIRION**  
TECHNOLOGIES

Copyright © 2024 Mirion Technologies, Inc. or its affiliates. All rights reserved. Mirion, the Mirion logo, and other trade names of Mirion products listed herein are registered trademarks or trademarks of Mirion Technologies, Inc. or its affiliates in the United States and other countries. Third party trademarks mentioned are the property of their respective owners.



RAMSYS™

# SIMS2™

## SIMulation Software

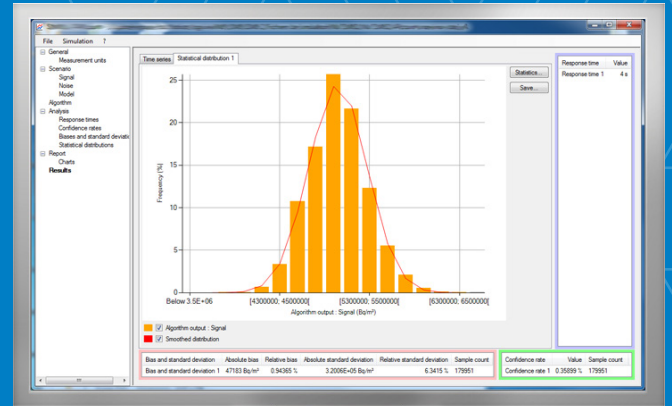

The SIMS2 has been developed for algorithm response simulation for RAMSYS measurement channels.

### DESCRIPTION

This software is a powerful tool designed to provide a measurement channel/algorithm combination:

- The evolution of measurement conditions over time (activity concentrations, dose rate, flow rate...)
- The measurement channel detection assembly (detection efficiencies, sensitivities to electronic noise and nuclear backgrounds...)
- The evolution over time of the measurements for a channel/algorithm combination under a set of conditions

### FEATURES

- ✓ Response time evaluation
- ✓ Statistical and distribution evaluation
- ✓ Confidence rate evaluation
- ✓ User friendly training tools
- ✓ Ergonomic, user friendly, Windows® based interface

## SIMS2™ SIMULATION SOFTWARE

### STANDARD FUNCTIONS

A simulation contains six functional groups of parameters. Parameters saved can be entered manually or read in a file. These groups of parameters are as follows:

- **General:** name of the simulation, units used throughout the simulation, origin of the measurements, etc.
- **Scenario:** description of the evolution of the measurement conditions over time, including:
  - Simulation duration
  - Evolution over time of the physical quantities which influence the measurements
  - Events which influence the measurements
- **Model:** description of the detection assembly characteristics including:
  - Detection efficiencies of the radioisotopes
  - Sensitivity to the different nuclear backgrounds
  - Intrinsic and electronic noise
- **Algorithm:** description of the algorithm parameters (accessed from the MASS2 software)
- **Analysis:** description of the statistical analyses to be performed:
  - Definition of the confidence rates to be evaluated
  - Definition of bias and standard deviation
- **Reports:** description of the automatic reports to be made during or at the end of the simulation:
  - Numerical and/or graphical printing
  - Data storage

### SIMULATION BASED ON REAL MEASUREMENTS

It is possible to perform simulations in which the input values provided to the algorithm are not simulated values but are real measurements stored in ASCII files.

### REPETITION OF IDENTICAL SIMULATIONS

The same event can be performed several times with this SIMS2 functionality. This is especially advantageous when evaluating response times. Indeed, if several identical simulations using different pseudo-random number sequences are performed, reliable statistical information can be obtained about the response times.

### RUNNING A SEQUENCE OF SIMULATIONS

The SIMS2 software allows independent simulations to be run sequentially and automatically using a “batch” method.

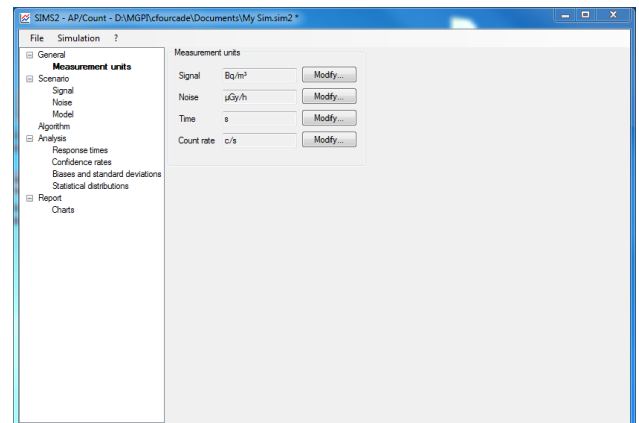

Example of general tab of parameters



**MIRION**  
TECHNOLOGIES

Copyright © 2024 Mirion Technologies, Inc. or its affiliates. All rights reserved. Mirion, the Mirion logo, and other trade names of Mirion products listed herein are registered trademarks or trademarks of Mirion Technologies, Inc. or its affiliates in the United States and other countries. Third party trademarks mentioned are the property of their respective owners.



RAMSYS™ & CAMSYS™

# Paper Filter

## FSLW Paper Filter Roll 52121

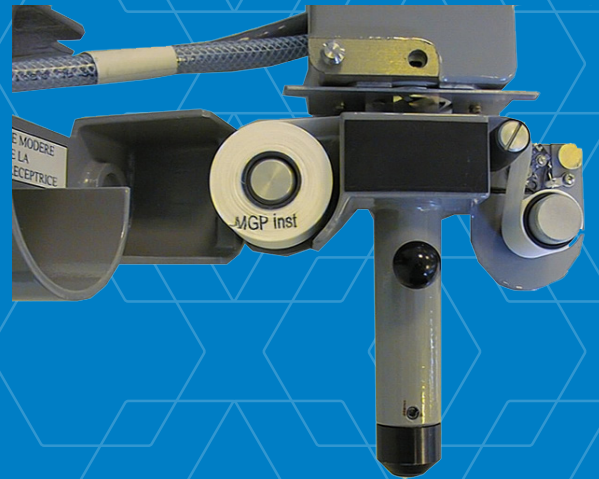

For RAMSYS and CAMSYS particulate monitors

### DESCRIPTION

This paper filter roll is used for RAMSYS and CAMSYS particulate monitors with sequential filter.

The sampled air is discharged downstream the pump. Radioactive particulates in the air are trapped on a filter facing the particulate sensors. Their activity are estimated by the processing unit.

The filter is stationary but advances through the sampling area automatically by a stepper motor which turns the take-up spool. The motor is controlled by the measurement board. The "filter advance" control can be periodic, on a fixed sample volume or automatic when the system detects a "clogged filter" and/or high count rate or high background, low flow rate.

### FEATURES

- ✓ Trapping of airborne particulates
- ✓ Thermal stability
- ✓ Filter roll sufficient to support 2 to 6 months of continuous operation (depending on the conditions of use and background) for RAMSYS monitor; up to 1 year in CAMSYS based on one filter change per day



## PAPER FILTER

### FILTER CHARACTERISTICS

- Type: FSLW (MERCK)
- Material: PTFE, 50% polyethylene and 50% polypropylene reinforcement
- Efficiency: 99.7% for particulates > Ø 0.15 µm
- Average pore diameter: 3 µm
- Average thickness: 125 µm
- Thermal stability: up to 130°C
- Air flow: 52.7 l/min/cm<sup>2</sup>

### ROLL CHARACTERISTICS

- External smooth surface
- Paper width: 34 mm
- Paper minimum length: 12 m
- Mandrel material: PVC
- Standard nominal flow rate: 35 to 45 l/min, depending on the monitor
- ΔP value: 130 +20/-50 hPA





CAMSYS™

# iCAM™ Filters

## Fixed Filter Card Options



Mirion Technologies offers several filter options for the iCAM™ alpha/beta air monitor.

### DESCRIPTION

- ICAM/FCF: FSLW membrane filter card, for improved alpha spectrum resolution with consequent reductions in MDA and false alarm rate
- ICAM/FCC: charcoal-loaded filter, for simultaneous beta particulate and molecular iodine monitoring
- ICAM/FCI: GFA filter card and charcoal-loaded filter, for simultaneous alpha particulate, beta particulate and molecular iodine monitoring
- ICAM/FCM: FMLB membrane filter card, for improved alpha spectrum resolution and lower MDA with increased flow rate compared to FSLW
- ICAM/FC: GFA glass fibre filter for high flow rate and long filter life

All filter cards include a tear off tab so that they can be counted in an iMatic after sampling.

### FEATURES

- ✓ ICAM/FCF:
  - > x 2 reduction in MDA, so 4–10 x reduction in false alarm rate
  - No changes in setup of iCAM required
- ✓ ICAM/FCC:
  - A low cost method for beta particulate and molecular <sup>131</sup>I monitoring (non-discriminating)
- ✓ ICAM/FCI:
  - A low cost method for alpha and beta particulate and molecular <sup>131</sup>I monitoring (non-discriminating)
- ✓ ICAM/FCM:
  - Improved alpha peaks resolution and MDA
  - Allows higher flow rate compared to ICAM/FCF
- ✓ ICAM/FC:
  - Extended filter lifetime
  - Lower operating costs

## iCAM™ FILTERS

### ICAM/FCF

- Type: FSLW
- Material: PTFE and support made of HD polyethylene
- Average pore diameter: 3 µm
- Useful diameter: 25 mm
- Thermal stability: up to 135 °C

This filter card can dramatically improve the iCAMs performance at a low cost. In particular, false alarm rates (already low in iCAM due to the adaptive radon compensation) can be reduced by a factor of up to ten for the same alarm levels and background conditions. This improvement is achieved by replacing the standard GFA filter card with the ICAM/FCF filter, which uses a Millipore Fluoropore FSLW 3 micron membrane filter (as used in the iCAM/MF). This gives far superior alpha spectrum resolution compared to the GFA filter, and so reduces the size of the tails of the radon and thoron daughter peaks, thus reducing the background in the U/Pu region and reducing the MDA and false alarm rate. In good operating conditions the standard deviation of the compensated alpha reading (and thus the MDA) is reduced by a factor of > 2, and in poor/high background conditions, the improvements are even more dramatic.

### ICAM/FCC

- Type: charcoal-loaded filter (Whatman type 72)
- Useful diameter: 25 mm
- This filter absorbs molecular iodine with very high efficiency, in addition to collecting particulate. <sup>131</sup>I, the most common iodine isotope of interest, has several high intensity betas and so will be detected with very high efficiency (~24%) by the iCAM's beta channel.
- **Detectable high-intensity beta energies:**
  - Isotope: <sup>131</sup>I
  - Half life: 8.0207 days
  - Mean beta energy: 181.92 keV
  - Intensity: 100.50 %

Iodine occurs in two distinct forms: molecular iodine, i.e. I<sub>2</sub>, is normally encountered as fission product from fuel or reprocessing. This form is readily collected by a charcoal-loaded filter paper such as ICAM/FCI. The second form is organic iodine, e.g. methyl iodide, more frequently encountered in nuclear medicine. This form is not readily absorbed by a thin filter, so a bulk iodine absorption cartridge must be used (as in the IM 201 monitors).

Iodine in the environment is also likely to have exchanged with organic molecules so a cartridge-type system such as the IM 201 monitors should be used for wide area environmental monitoring systems. The ICAM/FCC is not suitable for alpha particulate measurement due to the poor spectrum shape produced, but it is suitable for beta particulate in air monitoring. If simultaneous alpha, beta and iodine monitoring is required then use the ICAM/FCI filter.

### ICAM/FCI

- Type: glass fibre filter in GFA (for alpha and beta particulate) combined with a type 72 charcoal-loaded filter
- Useful diameter: 25 mm

Using the ICAM/FCI allows an iCAM to monitor for alpha and beta particulates and for molecular iodine simultaneously, with the comments above for the ICAM/FCC filter applying to the iodine monitoring. The only disadvantage of using this filter is the greater pressure drop caused by the two layers, with consequent reduction in the filter life (typically 1–2 days) compared to the lifetime of a standard GFA filter of 5–7 days. Note, <sup>129</sup>I and <sup>125</sup>I do not have a detectable beta emission and so will not be detected by an iCAM fitted with the ICAM/FCI or ICAM/FCC filters.

### ICAM/FCM

- Type: FMLW 5 µ filter (MERCK)
- Useful diameter: 25 mm

The FMLW filter used in the ICAM/FCM filter card is of identical material and construction to the FSLW filter material used in the ICAM/FCF, but with a larger mean pore size (5 µm as opposed to 3 µm). The improvement in spectrum resolution, and therefore performance, is therefore similar to that achieved with the FSLW filter, but with the added advantage that the filter does not clog up so quickly, allowing a high flow rate to be maintained for longer, especially in high dust loading applications. This can lead to lower MDAs, and therefore lower false alarm rates, than with the ICAM/FCF filter cards.

### ICAM/FC

- Type: GE/Whatman GFA random oriented glass fibre filter
- Diameter: 25 mm
- The ICAM/FC card replaces the ICAM/FCA one

The ICAM/FC filter gives a good compromise between resolution, flow rate and cost, with a single filter typically able to run for > 5 days in typical applications.



**MIRION**  
TECHNOLOGIES



PROTK™

**TKA™**

## Check Sources for Detectors



**Functional checks, periodical testing  
and recalibration of detectors.**

### DESCRIPTION

The check sources series TKA are designed for functional checks and for periodical testing and recalibration of detectors and monitoring systems for dose rate monitoring and activity monitoring.

Both, mobile versions for manual use and fixed installed versions for remote operation are available.

### FEATURES

- ✓ Easy handling
- ✓ Defined geometry
- ✓ Optimized activity of the check source
- ✓ Reproducible results

# TKA™ CHECK SOURCES FOR DETECTORS

## OVERVIEW

Type	Application	Dimensions/Mass	Check Source	Remarks
<b>Test equipment for ionization chambers, portable versions for manual testing, 5 positions for the check source</b>				
<b>TKA 15</b>	For KG 151	20 kg approx. (44 lb)	Cs-137; 37 MBq ... 1.11 GBq	} Lead housing with arrester for the detector  With detector support
<b>TKA 16</b>	For KG 220	16 kg approx. (35 lb)	Cs-137; 37 MBq ... 370 MBq	
<b>TKA 17</b>	For KG 122	16 kg approx. (35 lb)	Cs-137; 37 MBq ... 370 MBq	
<b>TKA 19</b>	For KG 80	20 kg approx. (44 lb)	Cs-137; 37 MBq ... 1.11 GBq	
<b>TKA 21</b>	For KG 80 SAx	15 kg approx. (33 lb)	Cs-137; 37 MBq ... 1.11 GBq	
<b>Remote check sources for ionization chambers</b>				
<b>TKA 65</b>	Div. ion-chambers	70 kg (154 lb)	Cs-137; 37 MBq ... 1.11 GBq	With rotary magnet
<b>TKA66.11</b>	For KG 122/151 or KG 220	25 kg approx. (55 lb)	Cs-137; 37 MBq ... 1.11 GBq	2 source positions (0/1)
<b>TKA 66.12</b>	For KG 122/151 or KG 220	25 kg approx. (55 lb)	Cs-137; 37 MBq ... 1.11 GBq	4 source positions
<b>TKA 66.22</b>	For KG 80	30 kg approx. (66 lb) (including detector)	Cs-137; 0.37 ... 1.11 GBq	4 source positions
<b>Check sources for scintillation detectors and GM-detectors, for manual testing</b>				
<b>TKA 04</b>	For SG 62/65/66	Ø 70 × 35 mm (2.7 x 1.3 in)	Cs-137; 185 kBq	Hood
<b>TKA 40</b>	For SB 40	~ Ø 70 × 30 mm (2.7 x 1.1 in)	C-14, Co-60, Cs-137, Sr 90	Hood
<b>TKA 42</b>	For SB 40/150	Ø 225 × 40 mm (8.8 x 1.5 in)	C-14, Sr 90; e.g. 3.7 kBq	Hood
<b>TKA 52</b>	For ZG 50	Ø 129 × 298 mm (5 x 11.7 in) (with transport container)	Cs-137; 3.7 MBq	
<b>Rod-shaped check sources for activity monitors, for manual testing</b>				
<b>TKA 10</b>	For noble gas vessels	Ø 10 (15) × 254 mm (0.4 (0.6) x 10 in)	Cs-137; 37 kBq ... 3.7 MBq	With transport container
<b>TKA 13</b>	Diverse measuring vessels	Ø 11 (28) × 600 mm (0.4 (1.1) x 23.6 in)	Cs-137; 7.4 kBq ... 111 MBq	With transport container
<b>Check source for particulate and iodine monitors</b>				
<b>TKA 47</b>	For AD/AG 24	Ø 40 × 4 mm (1.5 x 0.1 in)	Cs-137, Sr-90; 0.25 ... 3 kBq	Disc to replace filter
<b>TKA 48</b>	For JD 24	Ø 58 × 57 mm (2.3 x 2.2 in)	Ba-133, I-131; 4 ... 40 kBq	Insert for air inlet
<b>Remote operated check sources for activity monitors</b>				
<b>TKA 54</b>	For liquid monitors	464 or 553 mm travel (18.2 or 21.7 in)	Cs-137; 7.4 ... 37 kBq	With linear drive
<b>TKA 61</b>	For noble gas monitors	Ø 114 × 78 mm (4.5 x 3 in) 5.6 kg approx. (12.3 lb)	Sr-90; 0.37 ... 37 MBq	With rotary magnet
<b>TKA 63</b>	For sampling filter equipment	88 × 85 × 60 mm (3.4 x 3.3 x 2.3 in) 2 kg approx. (4.4 lb)	Cs-137; e.g. 10 MBq	With rotary magnet





**MIRION**  
TECHNOLOGIES

Copyright © 2024 Mirion Technologies, Inc. or its affiliates. All rights reserved. Mirion, the Mirion logo, and other trade names of Mirion products listed herein are registered trademarks or trademarks of Mirion Technologies, Inc. or its affiliates in the United States and other countries. Third party trademarks mentioned are the property of their respective owners.



# Monitors Range

Monitor ref.	Version	Vol.	1 kBq/m <sup>3</sup>	1 MBq/m <sup>3</sup>	1 GBq/m <sup>3</sup>	1 TBq/m <sup>3</sup>	1 PBq/m <sup>3</sup>
<b>B IONIX 3</b>							
	<b>CMP</b>	300 cc				6 kBq/m <sup>3</sup> to 6 TBq/m <sup>3</sup> 162 nCi/m <sup>3</sup> to 162 Ci/m <sup>3</sup>	
							<b>LD (2σ): 40 kBq/m<sup>3</sup> 1 μCi/m<sup>3</sup></b>
	<b>MES</b>	660 cc				3 kBq/m <sup>3</sup> to 3 TBq/m <sup>3</sup> 82 nCi/m <sup>3</sup> to 82 Ci/m <sup>3</sup>	
							<b>LD (2σ): 20 kBq/m<sup>3</sup> 0.5 μCi/m<sup>3</sup></b>
<b>M IONIX 3</b>							
	<b>XO</b>	4 200 cc				2.1 kBq/m <sup>3</sup> to 2.1 GBq/m <sup>3</sup> 54 nCi/m <sup>3</sup> to 54 Ci/m <sup>3</sup>	
							<b>LD (2σ): 12.5 kBq/m<sup>3</sup> 0.33 μCi/m<sup>3</sup></b>
	<b>XC</b>	4 200 cc				2.1 kBq/m <sup>3</sup> to 2.1 GBq/m <sup>3</sup> 54 nCi/m <sup>3</sup> to 54 Ci/m <sup>3</sup>	
							<b>LD (2σ): 20 kBq/m<sup>3</sup> 0.54 μCi/m<sup>3</sup></b>
<b>C IONIX 3</b>							
	<b>BLX</b>	195 cc				10 kBq/m <sup>3</sup> to 10 TBq/m <sup>3</sup> 0.27 μCi/m <sup>3</sup> to 270 Ci/m <sup>3</sup>	
	<b>BMX</b>	660 cc				3.2 kBq/m <sup>3</sup> to 3.2 TBq/m <sup>3</sup> 86 nCi/m <sup>3</sup> to 86 Ci/m <sup>3</sup>	
	<b>EXX</b>	4 200 cc				2 kBq/m <sup>3</sup> to 2 GBq/m <sup>3</sup> 54 nCi/m <sup>3</sup> to 54 Ci/m <sup>3</sup>	
							<b>LD (2σ): from 10 kBq/m<sup>3</sup> from 0.27 μCi/m<sup>3</sup></b>

# Samplers Range



HT IONIX 22



HC IONIX 20

The HT IONIX tritium and HC IONIX carbon samplers:

- Are available in 2 and 4 bottles versions
- Offer a touch-sensitive and user friendly interface
- Only need a quick and easy preventive maintenance
- Prevent the formation of condensation outside of the bottles
- Have a limited footprint and a weight reduced to its minimum (<15kg)
- Can communicate with the infrastructures as well as supervision software and be operated from a distance
- Offer very limited liquid loss thanks to an internally-developed advanced system: Relative Humidity Compensation System (RHCS)



# Detectors Range

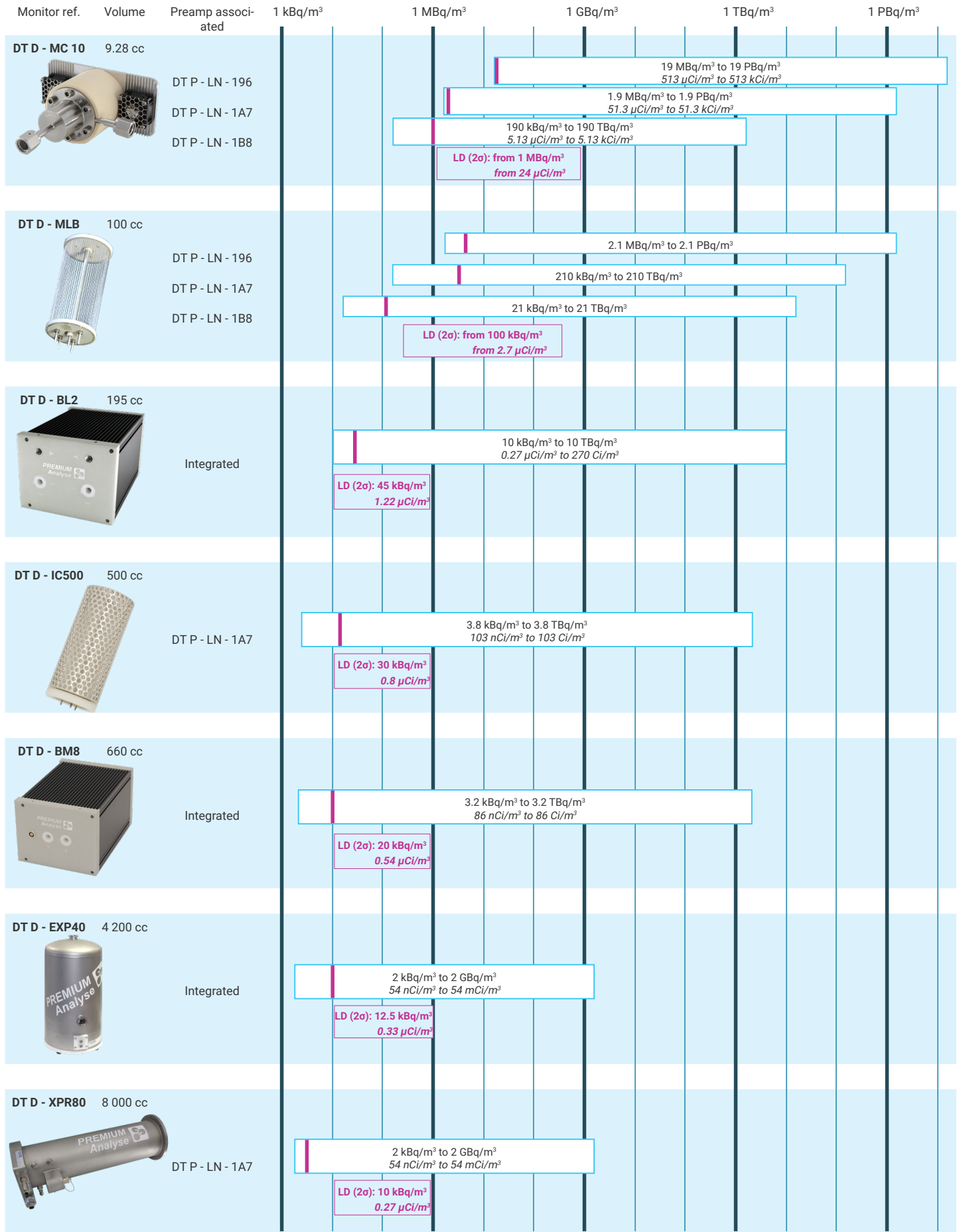



PREMIUM ANALYSE™

# HT ionix™

## Tritium Bubblers



The HT IONIX tritium bubblers are designed for trapping tritium oxide (HTO) as well as gas (HT). This method has a proven efficiency for radioprotection purposes, environmental surveillance as well as stack release monitoring.

### DESCRIPTION

The HT IONIX bubblers product range gathers several samplers designed for monitoring levels of atmospheric tritium both HTO (vapor) form and HT (gas).

The HT IONIX bubblers are suitable for all applications in stack and ventilation systems monitoring, surveillance of premises or even environmental monitoring.

These devices have been designed according to the requirements of the NF ISO 20045 and NF ISO 20041-1 standards.

Easy to use, light and rugged, these bubblers offer some of the most advanced features, such as:

- Reduced liquid volume
- Remote monitoring and control via Modbus
- Record of defects and measurement conditions

The HT IONIX bubblers can be easily and quickly converted into HC IONIX bubblers for sampling and trapping Carbon-14, thanks to a conversion kit available as an option.

### FEATURES

#### ✓ High trapping efficiency

- HTO & HT > 95%
- Trapping efficiency validated in laboratory

#### ✓ Convenient

- Intuitive to use
- Limited liquid loss
- Quick and easy set up
- No outside condensation

#### ✓ Easy maintenance

- Small footprint
- Stainless steel sampling circuit
- Light (weight < 15 kg) and rugged
- Only one annual maintenance required

#### ✓ User-friendly

- Color touch screen
- Color identification of bottles



# HT IONIX™ TRITIUM BUBBLERS

## MAIN CHARACTERISTICS

- The HT IONIX bubblers are available in two versions:
  - The HT IONIX 20 bubbler allows sampling of tritium oxide (HTO).
  - The HT IONIX 22 bubbler allows sampling of tritium oxide (HTO) as well as gas (HT) after catalytic oxidation in a furnace.

	HT IONIX 20	HT IONIX 22
<b>Main characteristics</b>		
<b>Overall dimensions</b>	L 410 x H 315 x D 350 mm	L 510 x H 315 x D 350 mm
<b>Weight (empty)</b>	< 12 kg	< 15 kg
<b>Power supply</b>	100-240 Vac 50-60 Hz	
<b>Max power</b>	240 W	530 W
<b>Electrical protection</b>	Fuses 2 A (220 V) & 10 A (24 V)	
<b>Dry-contact outputs</b>	6 outputs (flow, pump, cooling, electronic, proper functioning, status error)	7 outputs (flow, pump, cooling, electronic, proper functioning, status error, furnace)
<b>Volume of bottles</b>	125 mL	
<b>Recommended liquid volume</b>	100 mL demineralized water	
<b>Sampling circuit</b>	100% stainless steel	
<b>Inlet filter</b>	1 µm fiberglass	
<b>Gas I/O</b>	6 mm Swagelok double ring connectors	
<b>Flow rate</b>	Customizable from 50 cc/min to 850 cc/min (3 L/h to 51 L/h)	
<b>Furnace temperature settings</b>	N.A	Recommended 450 °C, max 500 °C

## OPERATING CONDITIONS

- Use temperature: +2 °C to +48 °C (+35 °F to +118 °F)
- Storage temperature: -5 °C to +70 °C (+23 °F to +158 °F)
- Use pressure: 850 - 1 150 mbar abs
- Humidity: < 95% (without condensation)
- Protection level: IP40



HT IONIX 20  
Two bottles HTO tritium sampler

# HT IONIX™ TRITIUM BUBBLERS

## FEATURES

### Gas sample circuit:

- Sampling circuit 100% made in stainless steel
- Color identification of bottles to limit the risk of switching
- Installation and removal of bottles made easy thanks to a standard thread (GL 45)
- Filtration of particles up to 1 micron through a front mounted easily interchangeable filter
- Mass flowmeter, calibrated with a certified standard COFRAC flowmeter over the range of 50 to 850 cc/min (3 to 51 L/h)
- Relative Humidity Compensation system
  - No condensation outside of the bubbler
  - Reduced liquid losses in all bottles even on long measurement period (up to 1 month)
- Self-regulating catalytic oxidation furnace with durable catalyzer
- Reduced water sampling volume (from 60 mL) to limit the dilution of the sample

### Electronic control:

- Color touch screen
  - Display of the sampling history, real-time errors, sampling status history,...
  - Display of operating and sampling data (standardized flowrate, sampling duration, volume sampled,...)
  - Ability to reset the duration and volume sampled before each new measurement campaign on the main screen.
- Light and sound alarm
- 4-20 mA input for external flowmeter
- Autotest at startup and permanent self-control
- Remote beacon connector (additional beacon required)
- Modbus Ethernet connection allowing remote visualization of faults and the status of operation as well as unit remote control
- Dry-contact outputs for the transmission of faults (flow, pump, furnace, cooling, electronic, general failure)

Delivered with power supply cable, glass bottles, conformity certificate, user and maintenance manual and Modbus registers.

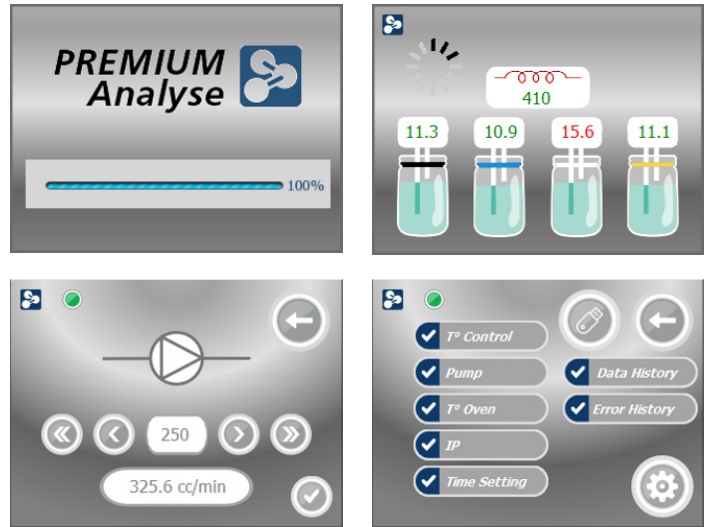

Software interface



Back of the device

## QUALIFICATIONS

- Tested in Mirion Technologies (Premium Analyse) tritium gas laboratory
- CE conformity
- Test reports available on request.



## HT IONIX™ TRITIUM BUBBLERS

REFERENCES	
HTO tritium bubbler	HT IONIX 20
HTO + HT tritium bubbler	HT IONIX 22

ACCESSORIES	
250 mL conversion kit (4 bottles)	HTI ACC 4F 250
Rolling table for 1 bubbler	HTI ACC TR1
Carrying basket for 8 bottles 250 mL	HTI ACC PT250
Clamp alarm beacon	ACC BAL P
Fixed alarm beacon	ACC BAL F
Transport case with foam block	HTI ACC PEL
Rinsing or decontamination system	HTI ACC SRD

CONSUMABLES	
Inlet sampling filter (pack of 100)	HTI SP FPR
RHCS fan	HTI SP VHR
RHCS fan filter (pack of 12)	HTI SP FHR
Case fan	HTI SP VBT 3
Case fan filter (pack of 6)	HTI SP FBT 3
Pump	HTI SP PPE

SPARE PARTS	
Pack of 4 125 mL bottles	HTI SP 4FL 125
Pack of 4 250 mL bottles	HTI SP 4FL 250
RHCS head	HTI SP SCHR 4
Oxidation furnace	HTI SP FOX
Diving tube for 125 mL bottle	HTI SP TP125 v3
PTH probe	HTI SP PTH
Flowmeter	HTI SP DEB 2
Gaskets kit (pack of 2)	HTI SP JNT
Power fuses (pack of 2)	HTI SP FUS 2A
Main board fuse	HTI SP FUS 10A
Touch screen assembly	HTI SP ECR
RHCS management card	SSP HTI GHR A1
System control card	SSP HTI EPE A3
NTC probe	HTI SP NTC 3

MAINTENANCE	
Annual maintenance kit without pump (FPR + FHR + FBT 3)	HTI MNT KIT 3
Annual maintenance kit with pump (FPR + FHR + FBT 3 + PPE)	HTI MNT KIT PPE 3
Annual maintenance fee	HTI MNT ANN

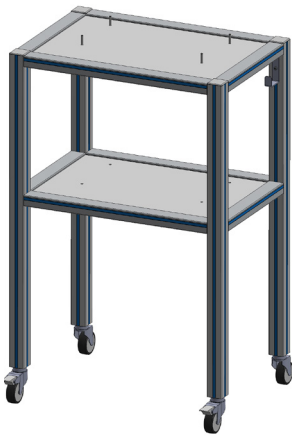

Rolling table  
HTI ACC TR1

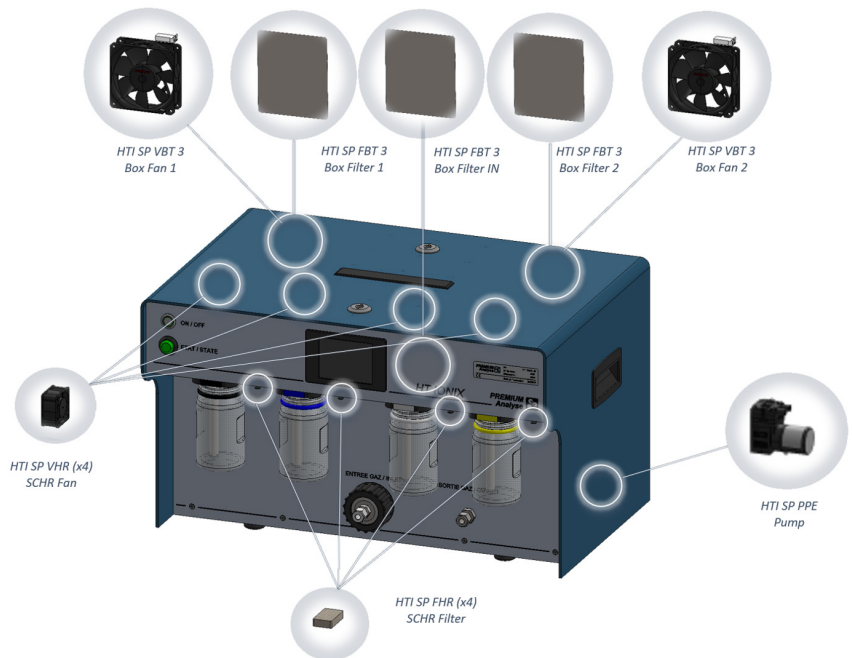

Copyright © 2025 Mirion Technologies, Inc. or its affiliates. All rights reserved. Mirion, the Mirion logo, and other trade names of Mirion products listed here in are registered trademarks or trademarks of Mirion Technologies, Inc. or its affiliates in the United States and other countries. Third party trademarks mentioned are the property of their respective owners.



PREMIUM ANALYSE™

# HC ionix™

## Carbon-14 Bubblers



The HC IONIX bubblers are designed for trapping carbon-14 in both gas and organic form. This method has a proven efficiency for radioprotection purposes, environmental surveillance as well as stack release monitoring.

### DESCRIPTION

The HC IONIX bubblers product range gathers several samplers designed for monitoring levels of atmospheric carbon-14, both gas and organic.

The HC IONIX bubblers are suitable for all applications in stack and ventilation systems monitoring, surveillance of premises or even environmental monitoring.

These devices have been designed according to the requirements of the NF ISO 20041-1 standards.

Easy to use, light and rugged, these bubblers offer some of the most advanced features, such as:

- Reduced liquid volume
- Remote control via Modbus Ethernet
- Record of defects and measurement conditions.

The HC IONIX bubblers can be easily and quickly converted into HT IONIX bubblers for sampling and trapping tritium, thanks to a conversion kit available as an option.

### FEATURES

- ✓ **High trapping efficiency**
  - CO<sub>2</sub> > 95%
  - Trapping efficiency validated in laboratory
- ✓ **Convenient**
  - Intuitive to use
  - Limited liquid loss
  - Quick and easy set up
  - No outside condensation
- ✓ **Easy maintenance**
  - Small footprint
  - Stainless steel sampling circuit
  - Light (weight < 15 kg) and rugged
  - Only one annual maintenance required
- ✓ **User-friendly**
  - Color touch screen
  - Color identification of bottles

## HC IONIX™ CARBON-14 BUBBLERS

### MAIN CHARACTERISTICS

- The HC IONIX bubblers are available in two versions:
  - The HC IONIX 20 bubbler allows sampling of carbon-14 in the CO<sub>2</sub> form,
  - The HC IONIX 22 bubbler allows sampling of carbon-14 in the CO<sub>2</sub> form as well as organic form after catalytic oxidation in a furnace.

	HC IONIX 20	HC IONIX 22
Main characteristics		
Overall dimensions	L 410 x H 315 x D 350 mm	L 510 x H 315 x D 350 mm
Weight (empty)	< 12 kg	< 15 kg
Power supply	100-240 Vac 50-60 Hz	
Max power	240 W	530 W
Electrical protection	Fuses 2 A (220 V) & 10 A (24 V)	
Dry-contact outputs	6 outputs (flow, pump, cooling, electronic, proper functioning, status error)	7 outputs (flow, pump, cooling, electronic, proper functioning, status error, furnace)
Volume of bottles	250 mL	
Recommended liquid volume	175 mL of liquid	
Sampling circuit	100% stainless steel	
Inlet filter	1 µm fiberglass	
Gas I/O	6 mm Swagelok double ring connectors	
Flow rate	Customizable from 50 cc/min to 850 cc/min (3 L/h to 51 L/h)	
Furnace temperature settings	N.A	Recommended 450 °C, max 500 °C

### OPERATING CONDITIONS

- Use temperature: +2 °C to +48 °C (+35 °F to +118 °F)
- Storage temperature: -5 °C to +70 °C (+23 °F to +158 °F)
- Use pressure: P<sub>atmospheric</sub>
- Humidity: < 95% (without condensation)
- Protection level: IP40



HC IONIX 20

Two bottles CO<sub>2</sub> sampler

## HC IONIX™ CARBON-14 BUBBLERS

### FEATURES

#### Gas sample circuit:

- Sampling circuit 100% made in stainless steel
- Color identification of bottles to limit the risk of switching
- Installation and removal of bottles made easy thanks to a standard thread (GL 45)
- Filtration of particles up to 1 micron through a front mounted easily interchangeable filter
- Mass flowmeter, calibrated with a certified standard COFRAC flowmeter over the range of 50 to 850 cc/min (3 to 51 L/h)
- Relative Humidity Compensation system
  - No condensation outside of the bubbler
  - Reduced liquid losses in all bottles even on long measurement period (up to 1 month)
- Self-regulating catalytic oxidation furnace with durable catalyzer
- Connectors for the rinsing system easy to reach on the back panel

#### Electronic control:

- Color touch screen
  - Display of the sampling history, real-time errors, sampling status history,...
  - Display of operating and sampling data (standardized flowrate, sampling duration, volume sampled,...)
- Ability to reset the duration and volume sampled before each new measurement campaign on the main screen.
- Light and sound alarm
- 4-20 mA input for external flowmeter
- Autotest at startup and permanent self-control
- Remote beacon connector (additional beacon required)
- Modbus Ethernet connection allowing remote visualization of faults and the status of operation as well as unit remote control
- Dry-contact outputs for the transmission of faults (flow, pump, furnace, cooling, electronic, general failure)

Delivered with power supply cable, glass bottles, conformity certificate, user and maintenance manual and Modbus registers.

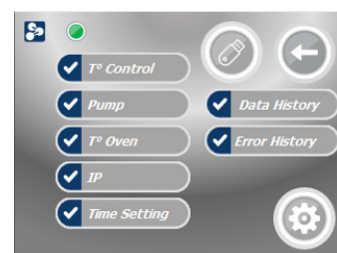
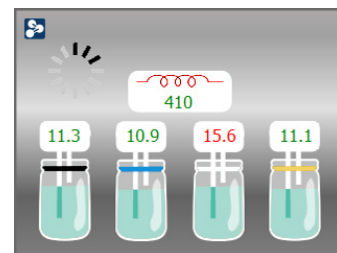
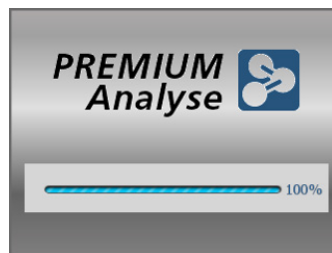

Software interface



Back of the device

### QUALIFICATIONS

- Tested in Mirion Technologies (Premium Analyse) gas laboratory
- CE conformity
- Test reports available on request.



## HC IONIX™ CARBON-14 BUBBLERS

REFERENCES	
CO <sub>2</sub> carbon-14 bubbler	HC IONIX 20
CO <sub>2</sub> + CO carbon-14 bubbler	HC IONIX 22

ACCESSORIES	
125 mL conversion kit (4 bottles)	HTI ACC 4F 125
Rolling table for 1 bubbler	HTI ACC TR1
Carrying basket for 8 bottles 250 mL	HTI ACC PT250
Clamp alarm beacon	ACC BAL P
Fixed alarm beacon	ACC BAL F
Transport case with foam block	HTI ACC PEL
Rinsing or decontamination system	HTI ACC SRD

CONSUMMABLES	
Sampling filters (pack of 100)	HTI SP FPR
RHCS fan	HTI SP VHR
RHCS fan filter (pack of 12)	HTI SP FHR
Case fan	HTI SP VBT 3
Case fan filter (pack of 6)	HTI SP FBT 3
Pump	HTI SP PPE

SPARE PARTS	
Pack of 4 125 mL bottles	HTI SP 4FL 125
Pack of 4 250 mL bottles	HTI SP 4FL 250
RHCS head	HTI SP SCHR 4
Oxidation furnace	HTI SP FOX
Diving tube for 125 mL bottle	HTI SP TP125 v3
PTH probe	HTI SP PTH
Flowmeter	HTI SP DEB 2
Gaskets kit (pack of 2)	HTI SP JNT
Power fuses (pack of 2)	HTI SP FUS 2A
Main board fuse	HTI SP FUS 10A
Touch screen assembly	HTI SP ECR
RHCS management card	SSP HTI GHR A1
System control card	SSP HTI EPE A3
NTC probe	HTI SP NTC 3

MAINTENANCE	
Annual maintenance kit without pump (FPR + FHR + FBT 3)	HTI MNT KIT 3
Annual maintenance kit with pump (FPR + FHR + FBT 3 + PPE)	HTI MNT KIT PPE 3
Annual maintenance fee	HTI MNT ANN

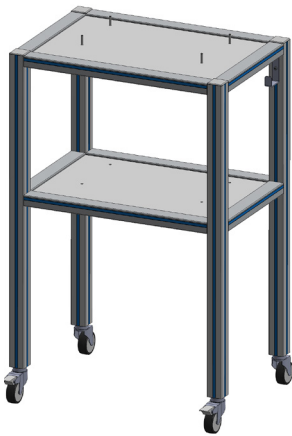

Rolling table  
HTI ACC TR1

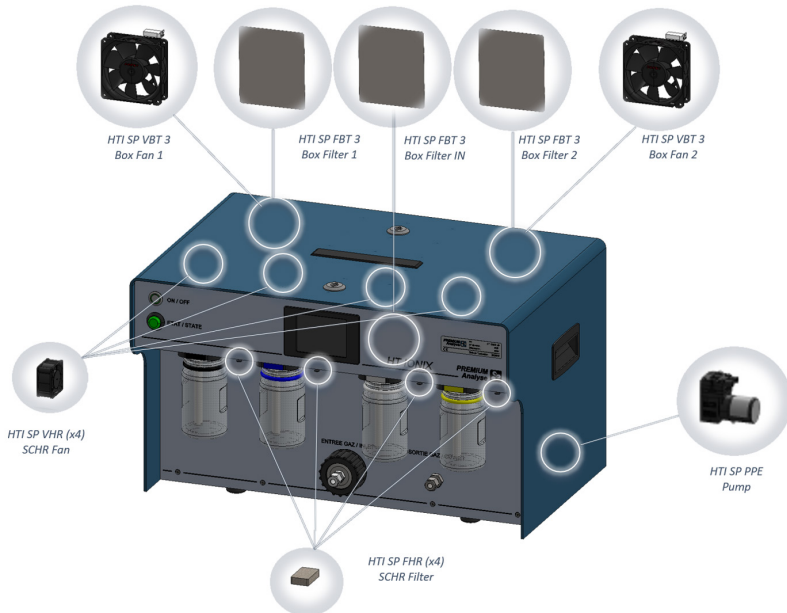

Copyright © 2025 Mirion Technologies, Inc. or its affiliates. All rights reserved. Mirion, the Mirion logo, and other trade names of Mirion products listed herein are registered trademarks or trademarks of Mirion Technologies, Inc. or its affiliates in the United States and other countries. Third party trademarks mentioned are the property of their respective owners.



PREMIUM ANALYSE™

# $\beta$ ionix™

## Portable Tritium Monitor



Portable tritium monitor for radioprotection purposes, environmental monitoring, laboratory surveillance, decommissioning jobs...

### DESCRIPTION

The portable monitor, B ionix has been designed for the real time monitoring of tritium and other  $\beta$  emitters activity in gases.

Thanks to its high sensitivity, its user-friendliness and its reliability, the B ionix portable monitor allows a continuous on-site measurement, ensuring the radiological protection of the teams, on dismantling and construction jobs for example, as well as process area monitoring, surveillance of premises,...

Ready to use, this portable monitor offers some of the most advanced features, such as: graphical plotting of measurements, archiving of data, remote display of the alarm statuses, data extraction via USB,...

The B ionix portable monitor is available in 2 versions:

- A simple measurement one with a single 660 cc ionization chamber
- A real time gamma background compensated one with 2 x 300 cc ionization chambers (one being sealed)

### FEATURES

- ✓ **High performance**
  - Continuous measurement
  - Response time from 60 seconds
  - Tritium detection from 20 kBq/m<sup>3</sup> (0.5  $\mu$ Ci/m<sup>3</sup>)
- ✓ **Simple**
  - Easy maintenance
  - User-friendly interface
  - Easy and fast commissioning
- ✓ **Reliable**
  - Precise and stable
  - Performance validated by the CTHIR laboratory
- ✓ **Easy to use**
  - Light and rugged
  - Color touch screen, graphical display



# B IONIX™ PORTABLE TRITIUM MONITOR

## FUNCTIONALITIES

- 2 customizable alarm thresholds
- Digital display of volumetric activity
- Ethernet Modbus TCP-IP connectivity
- Archiving of last 32 days of measurements
- Data extraction and system update via USB stick
- Monitoring of the flow rate with low flow detection
- Graphical plotting of measurements and alarm values on a scale from 8 minutes to 8 days
- Choice of volumetric activity among 15 units, with 4 customizable ones (Bq/m<sup>3</sup>, RCA, DAC, Ci/m<sup>3</sup>...)
- Light and sound signals when pre-alarm (orange) and alarm (red) thresholds are exceeded, as well as good operation default
- Weight: 6 kgs
- 6 hours autonomy, recharged in 2 hours
- Delivered with an external PSU 24V DC - 100W.
- In option: transport case, external remote beacon,...

## PERFORMANCE (For tritium)

Measurement characteristics in laboratory conditions (for tritium)	B IONIX 3 - MES Portable tritium monitor with manual gamma compensation	B IONIX - CMP Portable tritium monitor with automatic gamma compensation
Measurement range of the electronics	3 kBq/m <sup>3</sup> to 3 TBq/m <sup>3</sup> 82 nCi/m <sup>3</sup> to 82 mCi/m <sup>3</sup>	6 kBq/m <sup>3</sup> to 6 TBq/m <sup>3</sup> 162 nCi/m <sup>3</sup> to 162 Ci/m <sup>3</sup>
Limit of detection of the device (2σ)	20 kBq/m <sup>3</sup> (0.5 μCi/m <sup>3</sup> )	40 kBq/m <sup>3</sup> (1 μCi/m <sup>3</sup> )
Precision	5% of the reading ± 20 kBq/m <sup>3</sup> ± 0.5 μCi/m <sup>3</sup>	5% of the reading ± 40 kBq/m <sup>3</sup> ± 1 μCi/m <sup>3</sup>
Maximum deviation	20 kBq/m <sup>3</sup> /year ± 0.5 μCi/m <sup>3</sup> /year	40 kBq/m <sup>3</sup> /year ± 1 μCi/m <sup>3</sup> /year
Noise (2σ)	± 20 kBq/m <sup>3</sup> ± 0.5 μCi/m <sup>3</sup>	± 40 kBq/m <sup>3</sup> ± 1 μCi/m <sup>3</sup>
Response time	< 60 sec at 90% of step	< 90 sec at 90% of step
<b>Ionization chamber(s)</b>		
Volume	660 cc	2 x 300 cc
Nominal flow rate	4 L/m	2 L/m

## OPERATING CONDITIONS

- Use temperature: +0 °C to +40 °C (+32 °F to +104 °F)
- Humidity: < 95% relative, no condensation
- Influence of humidity: ± 1 % of the reading from 10 to 90% relative humidity
- Influence of temperature: 0.3%/°C for an ambient temperature variation < 3°C / hour
- Atmospheric pressure influence: 0.1 %/mbar, hence ± 5 % of the reading from 930 to 1030 mbar.

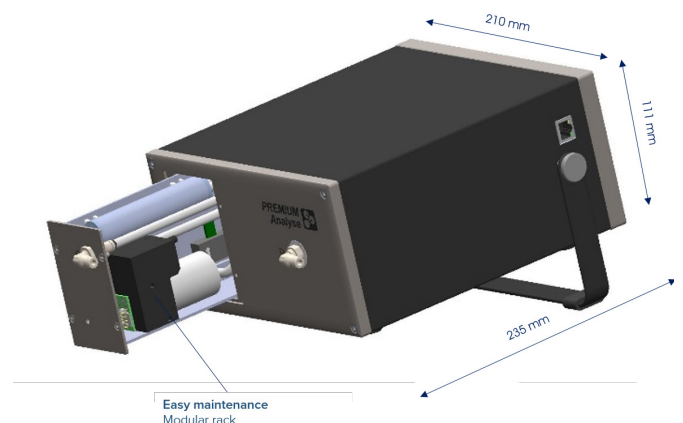

# B IONIX™ PORTABLE TRITIUM MONITOR

## CALIBRATION AND RESPONSE TO TRITIUM

The tests performed in our calibration laboratory are performed according to the NF EN 60761-1 and -5 standards, under 1-6856\* COFRAC ISO:17025 certification. The following tests can be performed upon request:

- The estimation of the limit of detection of the measurement chamber which is determined from the signal dispersion in a known environment (over a period of 8 hours)
- The determination of the conversion coefficient (calibration factor) for tritium (Bq/m<sup>3</sup>)/fA using a standardized tritium gas source
- The verification of the response with a source of standardized tritium gas
- The 3 points linearity verification with a source of standardized tritium gas
- The extended 7 points linearity verification with a source of standardized tritium gas
- The verification of the limit of detection at 8 points with a source of standardized tritium gas
- The estimation of the measurement response time with a source of standardized tritium gas
- The measurement of the response to a <sup>133</sup>Ba source used as a reference for the conformity tests performed at the end of manufacturing



Example of the response at 100 kBq/m<sup>3</sup>  
**B IONIX 3 – MES**  
 Volumetric activity measured

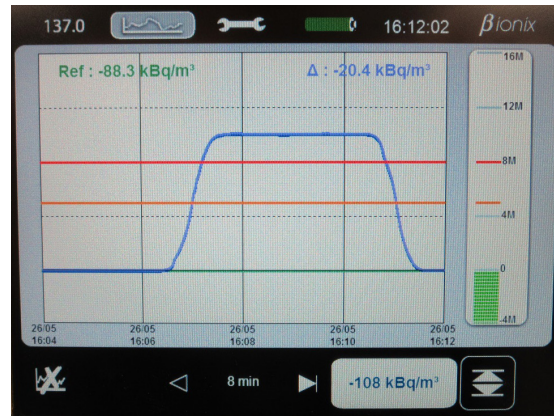

Example of the response at 10 MBq/m<sup>3</sup>  
**B IONIX 3 – CMP**  
 Volumetric activity measured

**PREMIUM Analyse**

*always one idea ahead*

**β** activity measurement  
<sup>3</sup>H, <sup>85</sup>Kr, <sup>133</sup>Xe  
<sup>222</sup>Rn, <sup>14</sup>C  
 Tritium

Test report  
**β ionix 3 – CMP** # 191

Laboratoire d'essais LAB IONIX  
 2 AC Euro-moselle Sud  
 9, rue de la Fontaine Chaudron  
 57140 - NORROY LE VENEUR  
 tél. + 33 (0)3 87 51 31 75  
 fax + 33 (0)3 87 51 31 74  
 www.premium-analyse.fr

Mirion Technologies (Premium-Analyse) SAS - SAS au capital de 100 000€ - RCS METZ 3 414 679 334 - SIRET 414 679 334 0004 - APE 2611B - TVA INTRA 414 679 334



Mirion Technologies (PREMIUM Analyse) gas laboratory based on the standard NF EN 60761-1 and -5

\* Accreditation details available on: [www.cofrac.fr/en](http://www.cofrac.fr/en)



Calibration reports available, gas calibration made upon request

## B IONIX™ PORTABLE TRITIUM MONITOR

### SERVICES

Our team is also capable of proposing accessories, making the handling and/or the use of the B ionix portable tritium monitor easier and more convenient. In addition to the gas test services, we can also provide extra deliveries, such as:

- The maintenance of monitors
- The training on the use of the monitors
- The training on the maintenance of the monitors
- The qualification of the devices to specific conditions (seismic,...)
- Engineering and design of custom made solutions for specific projects.

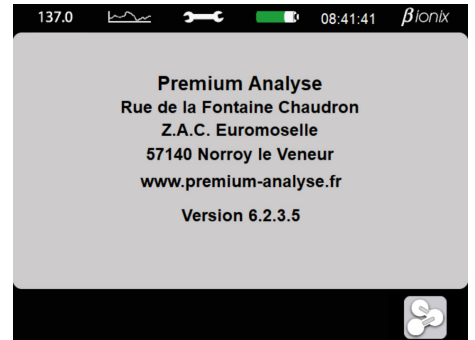

### ACCESSORIES AND PART NUMBERS

DEVICE REFERENCES	
Portable tritium monitor with manual gamma compensation	<b>B IONIX 3 - MES</b>
Portable tritium monitor with automatic gamma compensation	<b>B IONIX 3 - CMP</b>

SPARE PARTS	
12V pump for B IONIX 3 - MES	<b>BT3 SP PPE MES</b>
12V pump for B IONIX 3 - CMP	<b>BT3 SP PPE CMP</b>
Spare battery 10.8V - 8.7 Ah	<b>BT3 ACC BAT</b>

CONSUMABLES	
Epoxy filter - 0.9μ (Pack of 5)	<b>ACC FLT 5</b>
Epoxy filter - 0.9μ (Pack of 100)	<b>ACC FLT 100</b>

ACCESSORIES	
Fixed remote alarm beacon	<b>ACC BAL F</b>
Portable remote alarm beacon	<b>ACC BAL P</b>
Transport case	<b>BT3 ACC CASE</b>
Shoulder strap	<b>BT3 ACC STRAP</b>
Rolling table for B IONIX	<b>BTI ACC TAB</b>

SERVICES	
Training for users	<b>BT3 FMT USE</b>
Annual maintenance flat fee	<b>BT3 MNT ANN</b>



Copyright © 2025 Mirion Technologies, Inc. or its affiliates. All rights reserved. Mirion, the Mirion logo, and other trade names of Mirion products listed herein are registered trademarks or trademarks of Mirion Technologies, Inc. or its affiliates in the United States and other countries. Third party trademarks mentioned are the property of their respective owners.



PREMIUM ANALYSE™

# C ionix™ - BXX

## Installed Tritium Monitor



Installed tritium monitor for workplace monitoring, decommissioning, stack release or other applications.

### DESCRIPTION

The C ionix monitors have been designed for the real-time monitoring of tritium and other  $\beta$  emitters in gases.

Thanks to their high sensitivity and their reliability, the C ionix installed monitors provide a continuous monitoring for the surveillance of the premises as well as for stack discharge.

Wall mounted and within a minimal footprint the C ionix monitors contain a complete and compact tritium monitoring channel that can include a  $\gamma$  compensation channel.

The C ionix complete the range of monitors from the portable  $\beta$  ionix™ through the mobile M ionix™ by offering an installed solution ready to be connected.

Depending on the chosen configuration, the monitor can be used to separately and continuously measure the HTO activity of a gas mix containing other  $\beta$  emitters such as noble gases (see dedicated C ionix - HTO spec sheet).

### FEATURES

#### ✓ Performance

- Self-checking
- Continuous measurement
- Response time below 90 seconds
- Possibility for automatic  $\gamma$  compensation
- Detection of tritium from  $10 \text{ kBq/m}^3$  ( $0.27 \mu\text{Ci/m}^3$ )

#### ✓ Simple

- Ready to install
- User-friendly interface
- Dry contacts, Ethernet Modbus connectivity

#### ✓ Easy maintenance

- Minimal intervention
- Quick change components
- Simple  $\gamma$  source verification of system

## C IONIX™ - BXX INSTALLED TRITIUM MONITOR

### TECHNICAL CHARACTERISTICS

The C ionix monitors are available in several versions:

The versions below have been developed for real-time and continuous measurement of tritium activity and other  $\beta$  emitters in gases.

Measurement characteristics in laboratory conditions (for tritium)	C IONIX 3 - BLC	C IONIX 3 - BMM	C IONIX 3 - BMC
	Measurement with automatic gamma compensation	Measurement without automatic gamma compensation	Measurement with automatic gamma compensation
Measurement range of the electronics	10 kBq/m <sup>3</sup> to 10 TBq/m <sup>3</sup> 0.27 $\mu$ Ci/m <sup>3</sup> to 270 Ci/m <sup>3</sup>	3.2 kBq/m <sup>3</sup> to 3.2 TBq/m <sup>3</sup> 86 nCi/m <sup>3</sup> to 86 Ci/m <sup>3</sup>	3.2 kBq/m <sup>3</sup> to 3.2 TBq/m <sup>3</sup> 86 nCi/m <sup>3</sup> to 86 Ci/m <sup>3</sup>
Limit of detection (2 $\sigma$ ) of the device	45 kBq/m <sup>3</sup> (1.22 $\mu$ Ci/m <sup>3</sup> )	10 kBq/m <sup>3</sup> (0.27 $\mu$ Ci/m <sup>3</sup> )	20 kBq/m <sup>3</sup> (0.50 $\mu$ Ci/m <sup>3</sup> )
Precision	5% of the measurement $\pm$ 45 kBq/m <sup>3</sup> $\pm$ 1.22 $\mu$ Ci/m <sup>3</sup>	5% of the measurement $\pm$ 10 kBq/m <sup>3</sup> $\pm$ 0.27 $\mu$ Ci/m <sup>3</sup>	5% of the measurement $\pm$ 20 kBq/m <sup>3</sup> $\pm$ 0.50 $\mu$ Ci/m <sup>3</sup>
Maximum deviation	45 kBq/m <sup>3</sup> /year (1.22 $\mu$ Ci/m <sup>3</sup> /year)	10 kBq/m <sup>3</sup> /year (0.27 $\mu$ Ci/m <sup>3</sup> /year)	20 kBq/m <sup>3</sup> /year (0.50 $\mu$ Ci/m <sup>3</sup> /year)
Noise (2 $\sigma$ )	$\pm$ 10 kBq/m <sup>3</sup> (0.27 $\mu$ Ci/m <sup>3</sup> )	$\pm$ 10 kBq/m <sup>3</sup> (0.27 $\mu$ Ci/m <sup>3</sup> )	$\pm$ 20 kBq/m <sup>3</sup> (0.50 $\mu$ Ci/m <sup>3</sup> )
Response time	< 90 sec at 90% of step		
Ionization chamber(s)			
Volume	2 x 195 cc	1 x 660 cc	2 x 660 cc
Nominal flow rate	1 L/min	4 L/min	

The versions below can be used to separately and continuously measure the HTO activity of gases containing other  $\beta$  emitters such as noble gases:

Measurement characteristics in laboratory conditions (for tritium)	C IONIX 3 - BLH	C IONIX 3 - BMH
	HTO measurement with automatic gamma compensation	HTO measurement with automatic gamma compensation
Measurement range of the electronics	10 kBq/m <sup>3</sup> to 10 TBq/m <sup>3</sup> 0.27 $\mu$ Ci/m <sup>3</sup> to 270 Ci/m <sup>3</sup>	3.2 kBq/m <sup>3</sup> to 3.2 TBq/m <sup>3</sup> 86 nCi/m <sup>3</sup> to 86 Ci/m <sup>3</sup>
Limit of detection (2 $\sigma$ ) of the device	60 kBq/m <sup>3</sup> (1.62 $\mu$ Ci/m <sup>3</sup> )	20 kBq/m <sup>3</sup> (0.54 $\mu$ Ci/m <sup>3</sup> )
Precision	5% of the measurement $\pm$ 60 kBq/m <sup>3</sup> $\pm$ 1.62 $\mu$ Ci/m <sup>3</sup>	5% of the measurement $\pm$ 20 kBq/m <sup>3</sup> $\pm$ 0.54 $\mu$ Ci/m <sup>3</sup>
Maximum deviation	60 kBq/m <sup>3</sup> /year (1.62 $\mu$ Ci/m <sup>3</sup> /year)	20 kBq/m <sup>3</sup> /year (0.54 $\mu$ Ci/m <sup>3</sup> /year)
Noise (2 $\sigma$ )	$\pm$ 60 kBq/m <sup>3</sup> (1.62 $\mu$ Ci/m <sup>3</sup> )	$\pm$ 20 kBq/m <sup>3</sup> (0.54 $\mu$ Ci/m <sup>3</sup> )
Response time	< 90 sec at 90% of step	
Ionization chamber(s)		
Volume	2 x 195 cc	2 x 660 cc
Nominal flow rate	2 x 1 L/min	2 x 4 L/min

### OPERATING CONDITIONS

- Humidity: < 95% relative, no condensation
- Operating temperature: +0 °C to +40 °C (+32 °F to 104 °F)
- Influence of humidity:  $\pm$  1 % of the measurement from 10 to 90% of relative humidity
- Influence of temperature: 0.3%/°C for a variation of the ambient temperature < 3°C/hour
- Influence of atmospheric pressure: 0.1%/mbar, hence  $\pm$  5% of the measurement from 930 to 1030 mbar
- Protection index: IP 54

## C IONIX™ - BXX INSTALLED TRITIUM MONITOR

### POSSIBLE CONFIGURATIONS

Each unit integrates a DT ionix 3 digital touch interface allowing local viewing of data through an intuitive menu:

- 4 customizable alarm thresholds
- Digital display of volumetric activity
- Archiving of last 32 days of measurements
- Data extraction and system update via USB stick
- Adjustment and monitoring of the flow rate with low flow detection
- Graphical plotting of measurements and alarm values on a scale from 8 minutes to 8 days
- Choice of volumetric activity among 15 units, with 4 customizable ones (Bq/m<sup>3</sup>, RCA, DAC, Ci/m<sup>3</sup>...)
- Light and sound signals when pre-alarm (orange) and alarm (red) thresholds are exceeded, as well as good operation default
- Overall dimensions (with lights): W 475 x h 780 x d 330 mm (18.7 x 30.7 x 13")
- Weight (max.): 36 kg (79 lb)
- Power supply, max. power and electrical protection:
  - Option "2": 24 VDC, 60W, 6A fuse
  - Option "V": 85–264 VAC, 50/60 Hz, 80W differential circuit breaker 6A curve C
- Possible options:
  - Remote beacon connection
  - Wall mounting on quick mounting plate
  - Ethernet Modbus TCP-IP Connectivity (x2)
  - Gas I.O via self-sealing Stäubli or Swagelok fittings
  - Process output with dry contact outputs, 4/20mA outputs...
  - High leak-tightness configuration (leak rate < 10<sup>-9</sup> mbar.L.s<sup>-1</sup>)
  - Light and sound signals for alarms and good operation default

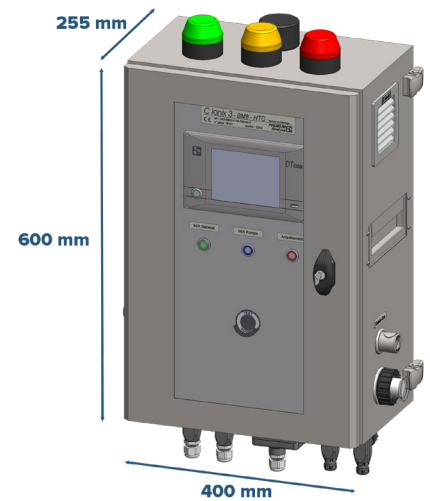

### TRITIUM RESPONSE EXAMPLES - VIEW FROM DT IONIX HMI

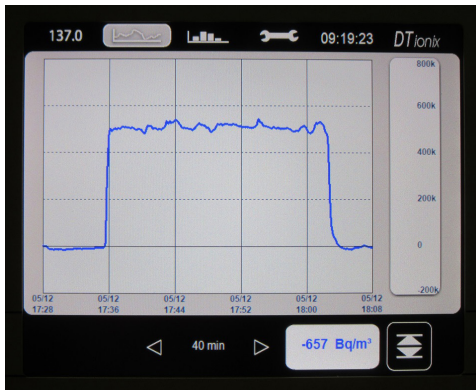

Injection of 500 kBq/m<sup>3</sup> (13.5 μCi/m<sup>3</sup>) in a C IONIX 3 - BMM

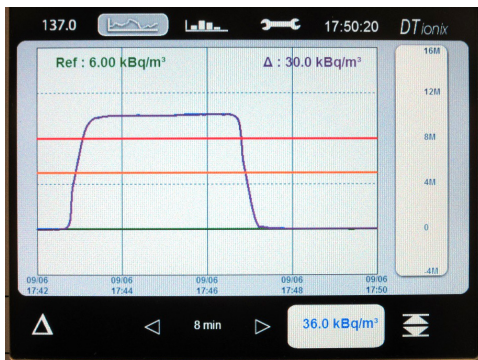

Injection of 10 MBq/m<sup>3</sup> (270 μCi/m<sup>3</sup>) in a C IONIX 3 - BLC

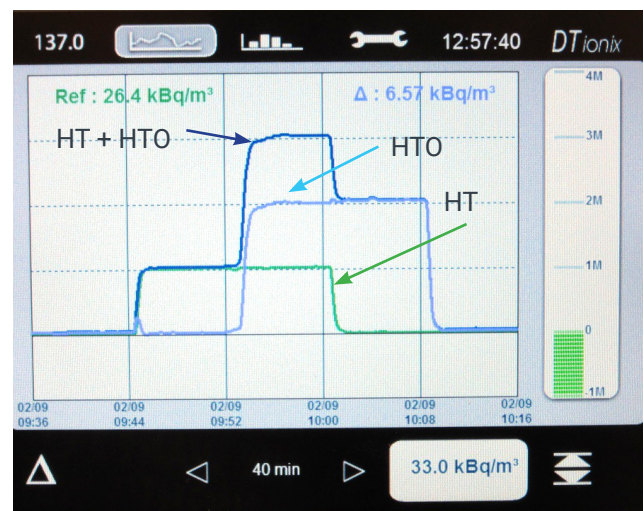

Injection of 1 MBq/m<sup>3</sup> (27 μCi/m<sup>3</sup>) of tritium HT then 2 MBq/m<sup>3</sup> (54 μCi/m<sup>3</sup>) of tritium HTO. The injection of HT is then stopped, and the injection of HTO is ceased thereafter.

# C IONIX™ - BXX INSTALLED TRITIUM MONITOR

## UNIT CONFIGURATION AND PART NUMBERS

MONITOR CONFIGURATION AND OPTIONS CHOICE		
Measurement		<b>C IONIX 3 - BLC - 0 - 00 - 00 - FA - F</b> <b>C IONIX 3 - BLH - 0 - 00 - 00 - FA - F</b> <b>C IONIX 3 - BMM - 0 - 00 - 00 - FA - F</b> <b>C IONIX 3 - BMC - 0 - 00 - 00 - FA - F</b> <b>C IONIX 3 - BMH - 0 - 00 - 00 - FA - F</b> <b>C IONIX 3 - BME - 0 - 00 - 00 - FA - F</b>
Power distribution	24V power supply AC power supply	<b>C IONIX 3 - BXX - 2 - XX - XX - FA - F</b> <b>C IONIX 3 - BXX - V - XX - XX - FA - F</b>
Alarms	Without light and sound Local alarms (G / R / O + sound) Remote beacon connector	<b>C IONIX 3 - BXX - X - 0X - XX - FA - F</b> <b>C IONIX 3 - BXX - X - YX - XX - FA - F</b> <b>C IONIX 3 - BXX - X - XB - XX - FA - F</b>
Connections	Process outputs (dry-contacts, 4-20mA, flow input) Modbus TCP-IP	<b>C IONIX 3 - BXX - X - XX - PX - FA - F</b> <b>C IONIX 3 - BXX - X - XX - XM - FA - F</b>
Wall fixing	Fixed system with Stäubli connectors Fixed system with Swagelok connectors Removable without wall plate (with handles & clip fixing) Lock	<b>C IONIX 3 - BXX - X - XX - XX - FA - F</b> <b>C IONIX 3 - BXX - X - XX - XX - IA - F</b> <b>C IONIX 3 - BXX - X - XX - XX - AA - F</b> <b>C IONIX 3 - BXX - X - XX - XX - FA - F</b>
Label	English French	<b>C IONIX 3 - EXX - X - XX - XX - FA - E</b> <b>C IONIX 3 - EXX - X - XX - XX - FA - F</b>
Reference example	C ionix monitor full option with automatic gamma compensation	<b>C IONIX 3 - BMC - V - YB - PM - FA - F</b>

ACCESSORIES	
Wall plate	<b>ACC PLM</b>
Fixed alarm beacon	<b>CX3 ACC BAL F</b>
Gas exhaust with silencer	<b>ACC ARG SIL</b>
RAC SWA 1/4RT gas exhaust + filter	<b>ACC ARG S4F</b>
Gas exhaust for 8 mm hose	<b>ACC ARG S08</b>
Gas exhaust for 6 mm hose	<b>ACC ARG S06</b>
Mobile frame for 1 C ionix - BXX	<b>CX3 ACC CHM 01</b>
Mobile frame for 2 C ionix - BXX	<b>CX3 ACC CHM 02</b>
Table frame for 1 C ionix - BXX	<b>CX3 ACC CHM TAB</b>

SPARE PARTS	
High leak-tight pump assembly	<b>CX3 SP BTR P6000</b>

CONSUMABLES	
24V pumps 5.5 Lpm (x1*)	<b>CX3 SP PPE</b>
IP 54 foam filter (x2*)	<b>SP 60715 182</b>
Cabinet fan (x1*)	<b>SP 8414N</b>
DT ionix axial fan (x1*)	<b>SP 412F</b>
DT ionix axial fan mounted on support (x1*)	<b>SP 412F P</b>
2µm PTFE filter (x1*)	<b>CX3 SP FE 4</b>

\* quantity needed for annual maintenance of monitor



Copyright © 2025 Mirion Technologies, Inc. or its affiliates. All rights reserved. Mirion, the Mirion logo, and other trade names of Mirion products listed herein are registered trademarks or trademarks of Mirion Technologies, Inc. or its affiliates in the United States and other countries. Third party trademarks mentioned are the property of their respective owners.



PREMIUM ANALYSE™

# C ionix™ - HTO

## Installed Tritium Monitor



Installed HTO activity monitor for workplace monitoring, decommissioning job monitoring, stack release and other applications.

### DESCRIPTION

The C ionix monitors have been designed for the real-time monitoring of tritium and other  $\beta$  emitters in gases.

Thanks to their high sensitivity and their reliability, the C ionix installed monitors provide a continuous monitoring for the surveillance of the premises as well as for stack discharge.

The HTO version allows for a real-time and continuous monitoring of HTO activity of gases containing other  $\beta$  emitters such tritium HT and/or noble gases.

Typically made for use in research facilities and heavy water reactors, they provide a precise, reliable and continuous measurement.

Thanks to the SAM™ (Membrane Separator) no additional waste is created. Moreover, there is no need for periodical consumable replacement as the SAM is made to last.

### FEATURES

#### ✓ Performance

- Self-checking
- Continuous measurement
- Automatic  $\gamma$  compensation
- Integrated light and sound alarms
- Response time below 90 seconds
- Detection of tritium from  $20 \text{ kBq/m}^3$  ( $0.54 \mu\text{Ci/m}^3$ )

#### ✓ Simple

- Ready to install
- User-friendly interface
- Dry contacts, Ethernet Modbus connectivity

#### ✓ Easy maintenance

- Minimal intervention
- Quick change components
- Simple  $\gamma$  source verification of system



# C IONIX™ - HTO INSTALLED TRITIUM MONITOR

## TECHNICAL CHARACTERISTICS

The C ionix - HTO monitors are available in several versions:

Measurement characteristics in laboratory conditions (given for tritium)	C IONIX 3 - BLH HTO measurement with automatic gamma compensation	C IONIX 3 - BMH HTO measurement with automatic gamma compensation
Measurement range of the electronics	10 kBq/m <sup>3</sup> to 10 TBq/m <sup>3</sup> 0.27 μCi/m <sup>3</sup> to 270 Ci/m <sup>3</sup>	3.2 kBq/m <sup>3</sup> to 3.2 TBq/m <sup>3</sup> 86 nCi/m <sup>3</sup> to 86 Ci/m <sup>3</sup>
Limit of detection (2σ) of the device	60 kBq/m <sup>3</sup> (1.62 μCi/m <sup>3</sup> )	20 kBq/m <sup>3</sup> (0.41 μCi/m <sup>3</sup> )
Precision	5% of the measurement ± 60 kBq/m <sup>3</sup> ± 1.62 μCi/m <sup>3</sup>	5% of the measurement ± 20 kBq/m <sup>3</sup> ± 0.54 μCi/m <sup>3</sup>
Maximum deviation	60 kBq/m <sup>3</sup> /year (1.62 μCi/m <sup>3</sup> /year)	20 kBq/m <sup>3</sup> /year (0.54 μCi/m <sup>3</sup> /year)
Noise (2σ)	± 60 kBq/m <sup>3</sup> (1.62 μCi/m <sup>3</sup> )	± 20 kBq/m <sup>3</sup> (0.54 μCi/m <sup>3</sup> )
Response time	< 90 sec at 90% of step	
Ionization chamber(s)		
Volume	2 x 195 cc	2 x 660 cc
Nominal flow rate	2 x 1 L/min	2 x 4 L/min

## OPERATING CONDITIONS

- Humidity: < 95% relative, no condensation
- Operating temperature: +0 °C to +40 °C (+32 °F to 104 °F)
- Influence of humidity: ± 1 % of the measurement from 10 to 90% of relative humidity
- Influence of temperature: 0.3%/°C for a variation of the ambient temperature < 3°C/hour
- Influence of atmospheric pressure: 0.1%/mbar, hence ± 5% of the measurement from 930 to 1030 mbar
- Protection index: IP 54

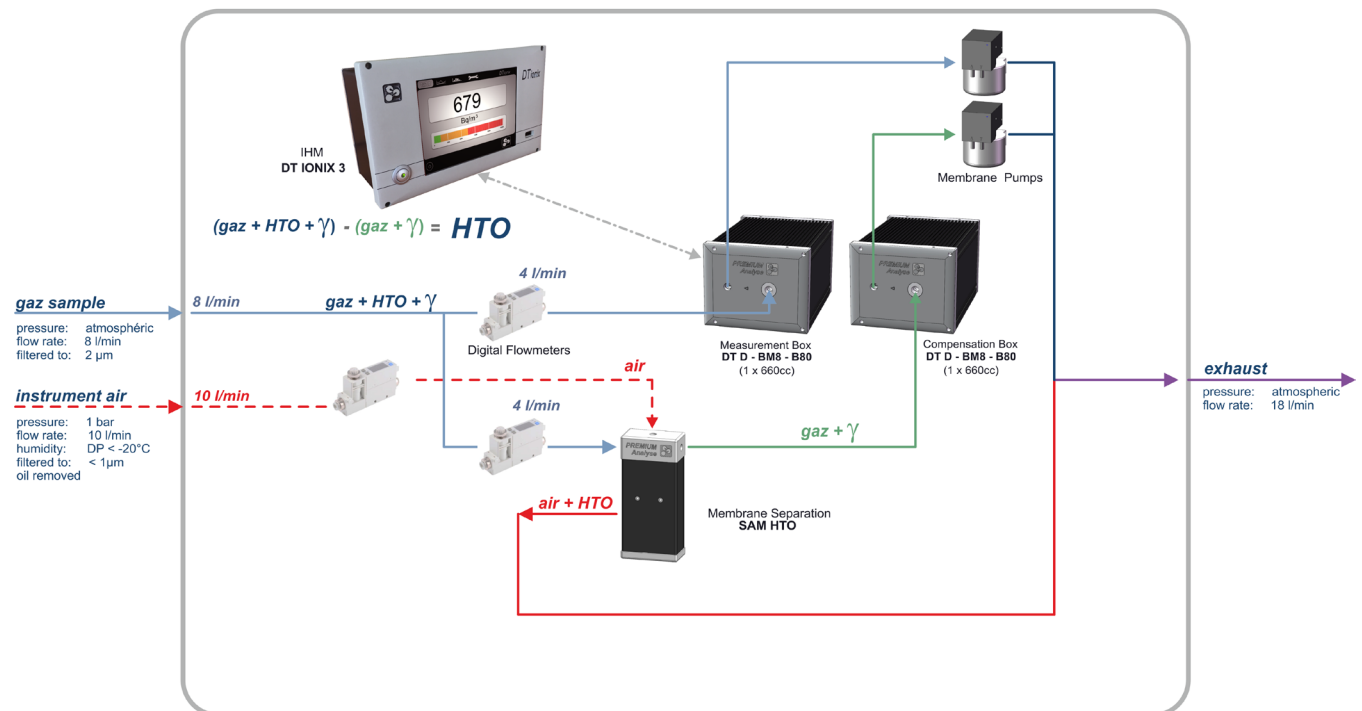

## C IONIX™ - HTO INSTALLED TRITIUM MONITOR

### POSSIBLE CONFIGURATIONS

Each unit integrates a DT ionix 3 digital touch interface allowing local viewing of data through an intuitive menu:

- 4 customizable alarm thresholds
- Digital display of volumetric activity
- Archiving of last 32 days of measurements
- Data extraction and system update via USB stick
- Adjustment and monitoring of the flow rate with low flow detection
- Graphical plotting of measurements and alarm values on a scale from 8 minutes to 8 days
- Choice of volumetric activity among 15 units, with 4 customizable ones (Bq/m<sup>3</sup>, RCA, DAC, Ci/m<sup>3</sup>...)
- Light and sound signals when pre-alarm (orange) and alarm (red) thresholds are exceeded, as well as good operation default
- Overall dimensions (with lights): W 475 x h 780 x d 330 mm (18.7 x 30.7 x 13")
- Weight (max.): 36 kg (79 lb)
- Power supply, max. power and electrical protection:
  - Option "2": 24 VDC, 60W, 6A fuse
  - Option "V": 85–264 VAC, 50/60 Hz, 80W differential circuit breaker 6A curve C
- Possible options:
  - Remote beacon connection
  - Wall mounting on quick mounting plate
  - Ethernet Modbus TCP-IP Connectivity (x2)
  - Gas I.O via self-sealing Stäubli or Swagelok fittings
  - Process output with dry contact outputs, 4/20mA outputs...
  - High leak-tightness configuration (leak rate < 10<sup>-9</sup> mbar.L.s<sup>-1</sup>)
  - Light and sound signals for alarms and good operation default

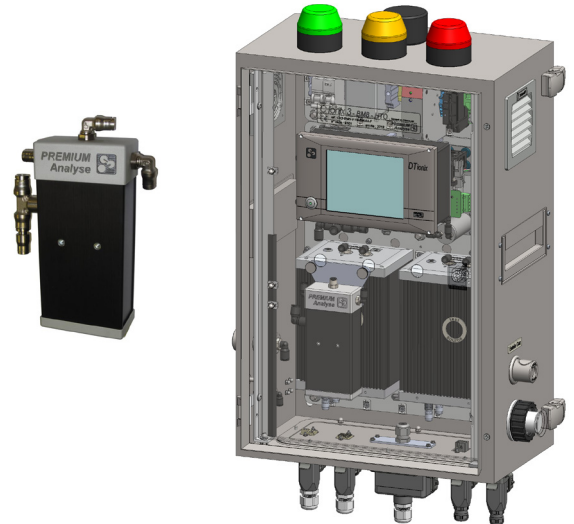

### SAM - MEMBRANE SEPARATION DEVICE

The SAM (Membrane Separator) provides the physical separation of tritium HTO from other gases.

It allows the activity measurement of tritium oxide HTO in a gas mix of HT + HTO, as well as the activity measurement of tritium oxide HTO in a gas mix of noble gases.

Unlike existing products on the market, it does not require replacement nor any maintenance hence does not create any contaminated waste.

Designed for continuous operation, it only requires dry instrument air to provide a precise and reliable measurement to research facilities as well as heavy water reactor facilities.

Integrated in the cabinet, the presence of this advanced device is transparent for the user. See the SAM HTO spec sheet for more information.

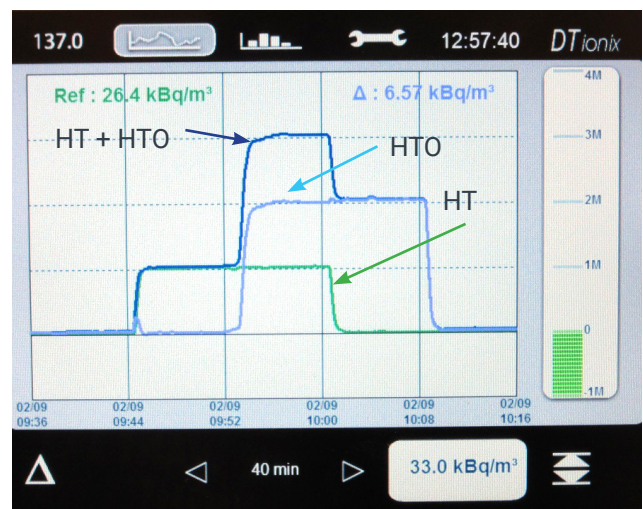

Injection of 1 MBq/m<sup>3</sup> (27 μCi/m<sup>3</sup>) of tritium HT then 2 MBq/m<sup>3</sup> (54 μCi/m<sup>3</sup>) of tritium HTO. The injection of HT is then stopped, and the injection of HTO is ceased thereafter.

# C IONIX™ - HTO INSTALLED TRITIUM MONITOR

## UNIT CONFIGURATION AND PART NUMBERS

MONITOR CONFIGURATION AND OPTIONS CHOICE		
Measurement		C IONIX 3 - BLH - 0 - 00 - 00 - FA - F C IONIX 3 - BMH - 0 - 00 - 00 - FA - F
Power distribution	24V power supply AC power supply	C IONIX 3 - BXX - 2 - XX - XX - FA - F C IONIX 3 - BXX - V - XX - XX - FA - F
Alarms	Without light and sound Local alarms (G / R / O + sound) Remote beacon connector	C IONIX 3 - BXX - X - 0X - XX - FA - F C IONIX 3 - BXX - X - YX - XX - FA - F C IONIX 3 - BXX - X - XB - XX - FA - F
Connections	Process outputs (dry-contacts, 4-20mA, flow input) Modbus TCP-IP	C IONIX 3 - BXX - X - XX - PX - FA - F C IONIX 3 - BXX - X - XX - XM - FA - F
Wall fixing	Installed system with Stäubli connectors Installed system with Swagelok connectors Removable without wall plate (with handles & clip fixing) Lock	C IONIX 3 - BXX - X - XX - XX - FA - F C IONIX 3 - BXX - X - XX - XX - IA - F C IONIX 3 - BXX - X - XX - XX - AA - F C IONIX 3 - BXX - X - XX - XX - FA - F
Version	English French	C IONIX 3 - BXX - X - XX - XX - FA - E C IONIX 3 - BXX - X - XX - XX - FA - F
Reference example	C ionix monitor full option with automatic gamma compensation	C IONIX 3 - BMH - V - YB - PM - FA - F

ACCESSORIES	
Wall plate	ACC PLM
Fixed alarm beacon	CX3 ACC BAL F
Gas exhaust with silencer	ACC ARG SIL
RAC SWA 1/4RT gas exhaust + filter	ACC ARG S4F
Gas exhaust for 8 mm hose	ACC ARG S08
Gas exhaust for 6 mm hose	ACC ARG S06
Mobile frame for 1 C ionix - BXX	CX3 ACC CHM 01
Mobile frame for 2 C ionix - BXX	CX3 ACC CHM 02
Table frame for 1 C ionix - BXX	CX3 ACC CHM TAB

SPARE PARTS	
High leak-tight pump assembly	CX3 SP BTR P6000

CONSUMABLES	
24V pumps 5.5 Lpm (x1*)	CX3 SP PPE
IP 54 foam filter (x2*)	SP 60715 182
Cabinet fan (x1*)	SP 8414N
DT ionix axial fan (x1*)	SP 412F
DT ionix axial fan mounted on support (x1*)	SP 412F P
2µm PTFE filter (x1*)	CX3 SP FE 4

\* quantity needed for annual maintenance of monitor



**MIRION**  
TECHNOLOGIES

Copyright © 2025 Mirion Technologies, Inc. or its affiliates. All rights reserved. Mirion, the Mirion logo, and other trade names of Mirion products listed herein are registered trademarks or trademarks of Mirion Technologies, Inc. or its affiliates in the United States and other countries. Third party trademarks mentioned are the property of their respective owners.



PREMIUM ANALYSE™

# SAM HTO™

## Membrane Separator



Membrane separator for physical separation of tritium HTO in all premises surveillance applications, stack monitoring or any other application.

### DESCRIPTION

The SAM HTO membrane separator enables the physical separation of tritium HTO from other gases.

It allows the measurement of tritium activity in the form of HTO in a mix HT + HTO, or the measurement of noble gases activity from which HTO can be removed.

It is adapted for applications in stack surveillance as well as process monitoring.

With no need for replacement or maintenance, it does not create any waste, thus presenting a valuable alternative to currently existing solutions.

### FEATURES

- ✓ **Simple**
  - Integrated monitors
  - No user-handling required
- ✓ **Reliable**
  - Maintenance-free
  - Continuous measurement

# SAM HTO™ MEMBRANE SEPARATOR

## SCHEMATIC DRAWING

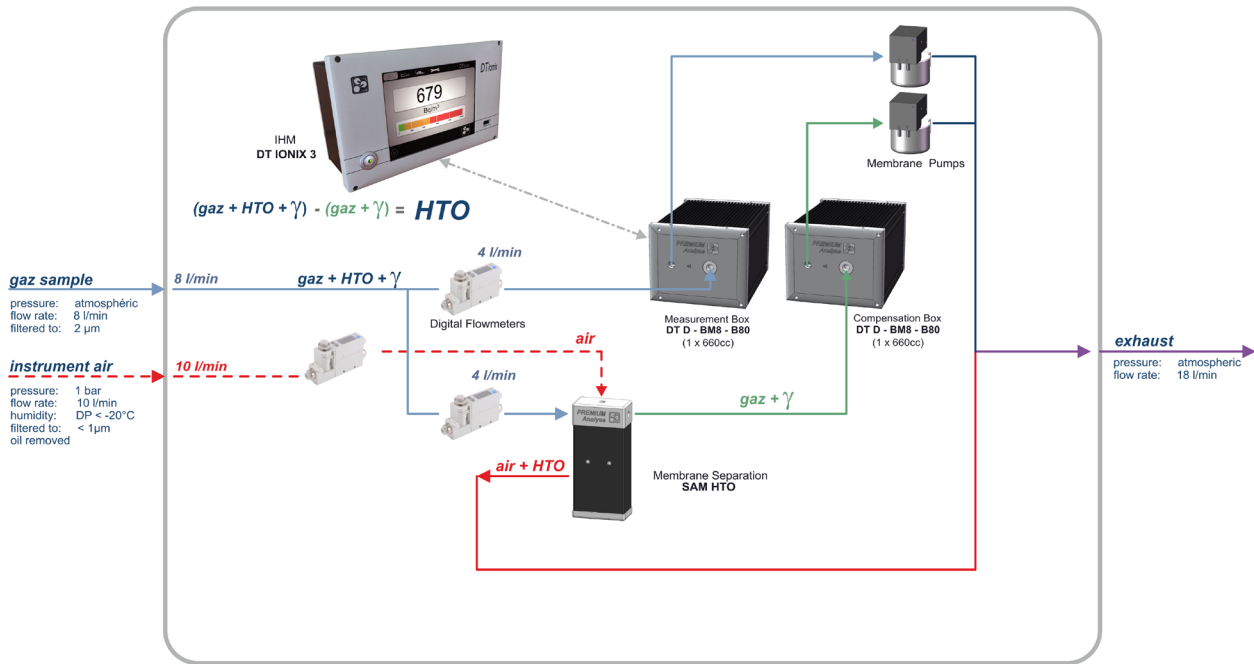

Schematic drawing of a C ionix 3 - BMH for the measurement of tritium HTO

Injection of 1 MBq/m<sup>3</sup> (27 µCi/m<sup>3</sup>) tritium in the form of HT, then of 2 MBq/m<sup>3</sup> (54 µCi/m<sup>3</sup>) of tritium in the form of HTO. The injection of HT is then stopped and finally the injection of HTO is stopped.

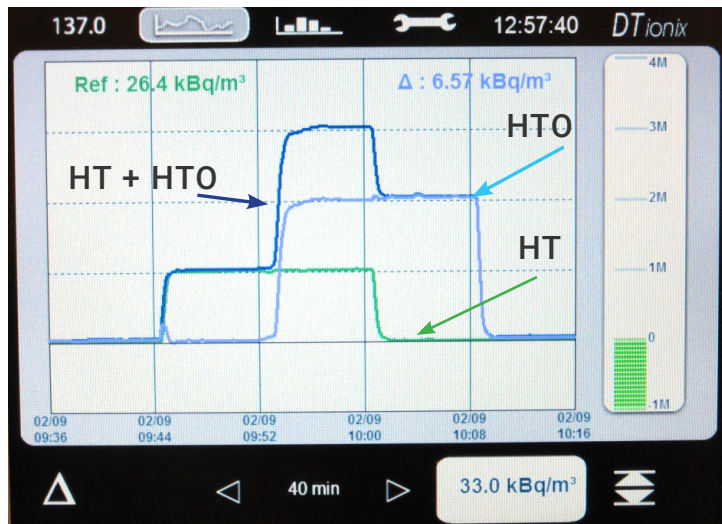

Copyright © 2025 Mirion Technologies, Inc. or its affiliates. All rights reserved. Mirion, the Mirion logo, and other trade names of Mirion products listed herein are registered trademarks or trademarks of Mirion Technologies, Inc. or its affiliates in the United States and other countries. Third party trademarks mentioned are the property of their respective owners.



PREMIUM ANALYSE™

# C ionix™ - GN

## Installed Noble Gas Monitor



Installed noble gas activity monitor for workplace monitoring, decommissioning job monitoring, stack release and other applications.

### DESCRIPTION

The C ionix monitors have been designed for the real-time monitoring of tritium and other  $\beta$  emitters in gases.

Due to their high sensitivity and their reliability, the C ionix installed monitors provide a continuous monitoring for the surveillance of the premises as well as for stack discharge.

The GN version has been designed to measure continuously the noble gas  $\beta$  emitters activity in a gas mix of noble gas + HTO.

Typically made for use in research facilities and heavy water reactors, they provide a precise and reliable measurement.

Thanks to the SAM (Membrane Separator) no additional waste is created. Moreover, there is no need for periodical consumable replacement as the SAM is made to be last. The measurement performances are linked to the element chosen ( $^{85}\text{Kr}$ ,  $^{133}\text{Xe}$ ,  $^{222}\text{Rn}$ ,...). For more information regarding the measurement performances, please contact us.

### FEATURES

#### ✓ Performance

- Self-checking
- Continuous measurement
- Automatic  $\gamma$  compensation
- Response time from 90 seconds
- Integrated light and sound alarms

#### ✓ Simple

- Ready to install
- User-friendly interface
- Dry contacts, Ethernet Modbus connectivity

#### ✓ Easy maintenance

- Minimal intervention
- Quick change components
- Simple  $\gamma$  source verification of system

# C IONIX™ - GN INSTALLED NOBLE GAS MONITOR

## UNIT CONFIGURATION AND PART NUMBERS

MONITOR CONFIGURATION AND OPTIONS CHOICE		
Measurement monitor		C IONIX 3 - BLG - 0 - 00 - 00 - FA - F C IONIX 3 - BMG - 0 - 00 - 00 - FA - F
Power distribution	24V power supply AC power supply	C IONIX 3 - BXX - 2 - XX - XX - FA - F C IONIX 3 - BXX - V - XX - XX - FA - F
Alarms	Without light and sound Local alarms (G / R / O + sound) Remote beacon connector	C IONIX 3 - BXX - X - 0X - XX - FA - F C IONIX 3 - BXX - X - YX - XX - FA - F C IONIX 3 - BXX - X - XB - XX - FA - F
Connections	Process outputs (dry-contacts, 4-20mA, flow input) Modbus TCP-IP	C IONIX 3 - BXX - X - XX - PX - FA - F C IONIX 3 - BXX - X - XX - XM - FA - F
Wall fixing	Installed system with STAUBLI connectors Installed system with SWAGELOK INCH connectors Mobile system without wall plate (with handles & clip fixing) Lock	C IONIX 3 - BXX - X - XX - XX - FA - F C IONIX 3 - BXX - X - XX - XX - IA - F C IONIX 3 - BXX - X - XX - XX - AA - F C IONIX 3 - BXX - X - XX - XX - FA - F
Version	English French	C IONIX 3 - BXX - X - XX - XX - FA - E C IONIX 3 - BXX - X - XX - XX - FA - F
Reference example	C ionix monitor full option with automatic gamma compensation	C IONIX 3 - BMG - V - YB - PM - FA - F

ACCESSORIES	
Wall plate	ACC PLM
Fixed alarm beacon	CX3 ACC BAL F
Gas exhaust with silencer	ACC ARG SIL
RAC SWA 1/4RT gas exhaust + filter	ACC ARG S4F
Gas exhaust for 8 mm hose	ACC ARG S08
Gas exhaust for 6 mm hose	ACC ARG S06
Mobile frame for 1 C ionix - BXX	CX3 ACC CHM 01
Mobile frame for 2 C ionix - BXX	CX3 ACC CHM 02
Table frame for 1 C ionix - BXX	CX3 ACC CHM TAB

SPARE PARTS	
High leak-tight pump assembly	CX3 SP BTR P6000

CONSUMABLES	
24V pumps 5,5 Lpm (x1*)	CX3 SP PPE
IP 54 foam filter (x2*)	SP 60715 182
Cabinet fan (x1*)	SP 8414N
DT ionix axial fan (x1*)	SP 412F
DT ionix axial fan mounted on support (x1*)	SP 412F P
2µm PTFE filter (x1*)	CX3 SP FE 4

\* quantity needed for annual maintenance of monitor

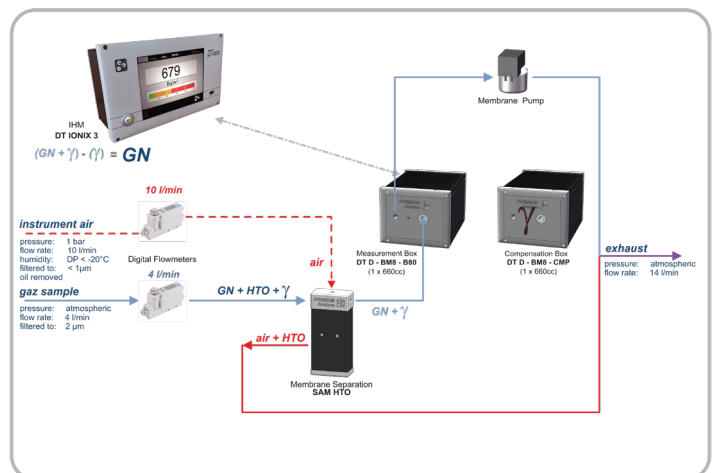

Copyright © 2025 Mirion Technologies, Inc. or its affiliates. All rights reserved. Mirion, the Mirion logo, and other trade names of Mirion products listed herein are registered trademarks or trademarks of Mirion Technologies, Inc. or its affiliates in the United States and other countries. Third party trademarks mentioned are the property of their respective owners.



PREMIUM ANALYSE™

# C ionix™ - EXX

## Installed Tritium Monitor



Installed tritium monitor for workplace monitoring, decommissioning, stack release or other applications.

### DESCRIPTION

The C ionix monitors have been designed for the real-time monitoring of tritium and other  $\beta$  emitters in gases.

Thanks to their high sensitivity and their reliability, the C ionix installed monitors provide a continuous monitoring for the surveillance of the premises as well as for stack discharge.

Wall mounted and within a minimal footprint the C ionix monitors contain a complete and compact tritium monitoring channel that can include a  $\gamma$  compensation channel.

The C ionix complete the range of monitors from the portable  $\beta$  ionix™ through the mobile M ionix™ by offering an installed solution ready to be connected.

As an option, the monitors can automatically compensate the  $\gamma$  environment due to a compensation detector that can be installed.

### FEATURES

#### ✓ High-performance

- Self-checking
- Continuous measurement
- Response time below 3 minutes
- Integrated light and sound alarms
- Possibility for automatic  $\gamma$  compensation
- Detection of tritium from  $10 \text{ kBq/m}^3$  ( $0.27 \mu\text{Ci/m}^3$ )

#### ✓ Simple

- Ready to install
- User-friendly interface
- Dry contacts, Ethernet Modbus connectivity

#### ✓ Easy maintenance

- Minimal intervention
- Quick change components
- Simple  $\gamma$  source verification of system



## C IONIX™ - EXX INSTALLED TRITIUM MONITOR

### TECHNICAL CHARACTERISTICS

The C ionix - EXX monitors are available in several versions:

The versions below have been developed for real-time and continuous measurement of tritium activity and other  $\beta$  emitters in gases:

Measurement characteristics in laboratory conditions (given for tritium)	C IONIX - EXM	C IONIX - EXC
	Tritium measurement with manual gamma compensation	Tritium measurement with automatic gamma compensation
Measurement range of the electronics	2 kBq/m <sup>3</sup> to 2 GBq/m <sup>3</sup> 54 nCi/m <sup>3</sup> to 54 mCi/m <sup>3</sup>	2 kBq/m <sup>3</sup> to 2 GBq/m <sup>3</sup> 54 nCi/m <sup>3</sup> to 54 mCi/m <sup>3</sup>
Limit of detection (2 $\sigma$ ) of the device	10 kBq/m <sup>3</sup> (0.27 $\mu$ Ci/m <sup>3</sup> )	15 kBq/m <sup>3</sup> (0.41 $\mu$ Ci/m <sup>3</sup> )
Precision	5% of the measurement $\pm$ 10 kBq/m <sup>3</sup> $\pm$ 0.27 $\mu$ Ci/m <sup>3</sup>	5% of the measurement $\pm$ 15 kBq/m <sup>3</sup> $\pm$ 0.41 $\mu$ Ci/m <sup>3</sup>
Maximum deviation	10 kBq/m <sup>3</sup> /year (0.27 $\mu$ Ci/m <sup>3</sup> /year)	15 kBq/m <sup>3</sup> /year (0.41 $\mu$ Ci/m <sup>3</sup> /year)
Noise (2 $\sigma$ )	$\pm$ 10 kBq/m <sup>3</sup> (0.27 $\mu$ Ci/m <sup>3</sup> )	$\pm$ 15 kBq/m <sup>3</sup> (0.41 $\mu$ Ci/m <sup>3</sup> )
Response time	< 3 min at 90% of step	
Ionization chamber(s)		
Volume	4 200 cc	2 x 4 200 cc
Nominal flow rate	20 L/min	

### OPERATING CONDITIONS

- Humidity: < 95% relative, no condensation
- Operating temperature: +0 °C to +40 °C (+32 °F to 104 °F)
- Influence of humidity:  $\pm$  1 % of the measurement from 10 to 90% of relative humidity
- Influence of temperature: 0.3%/°C for a variation of the ambient temperature < 3°C/hour
- Influence of atmospheric pressure: 0.1%/mbar, hence  $\pm$  5% of the measurement from 930 to 1030 mbar
- Protection index: IP 54

### COMMON CHARACTERISTICS

Each unit integrates a DT ionix 3 digital touch interface allowing local viewing of data through an intuitive menu:

- 4 customizable alarm thresholds
- Digital display of volumetric activity
- Archiving of last 32 days of measurements
- Data extraction and system update via USB stick
- Adjustment and monitoring of the flow rate with low flow detection
- Graphical plotting of measurements and alarm values on a scale from 8 minutes to 8 days
- Choice of volumetric activity among 15 units, with 4 customizable ones (Bq/m<sup>3</sup>, RCA, DAC, Ci/m<sup>3</sup>...)
- Light and sound signals when pre-alarm (orange) and alarm (red) thresholds are exceeded, as well as good operation default



## C IONIX™ - EXX INSTALLED TRITIUM MONITOR

### POSSIBLE CONFIGURATIONS

- Overall dimensions (with lights): W 600 x h 800 x d 400 mm (23.6 x 31.5 x 15.7")
- Weight (max.): 80 kg (177 lb)
- Power supply, max. power and electrical protection:
  - Option "2": 24 VDC , 120W, 6A fuse
  - Option "V": 85–264 VAC, 50/60 Hz, 120W differential circuit breaker 6A curve C
- Possible options:
  - Remote beacon connection
  - Wall mounting on quick mounting plate
  - Ethernet Modbus TCP-IP Connectivity (x2)
  - Process output with dry contact outputs, 4/20mA outputs...
  - Light and sound signals for alarms and good operation default

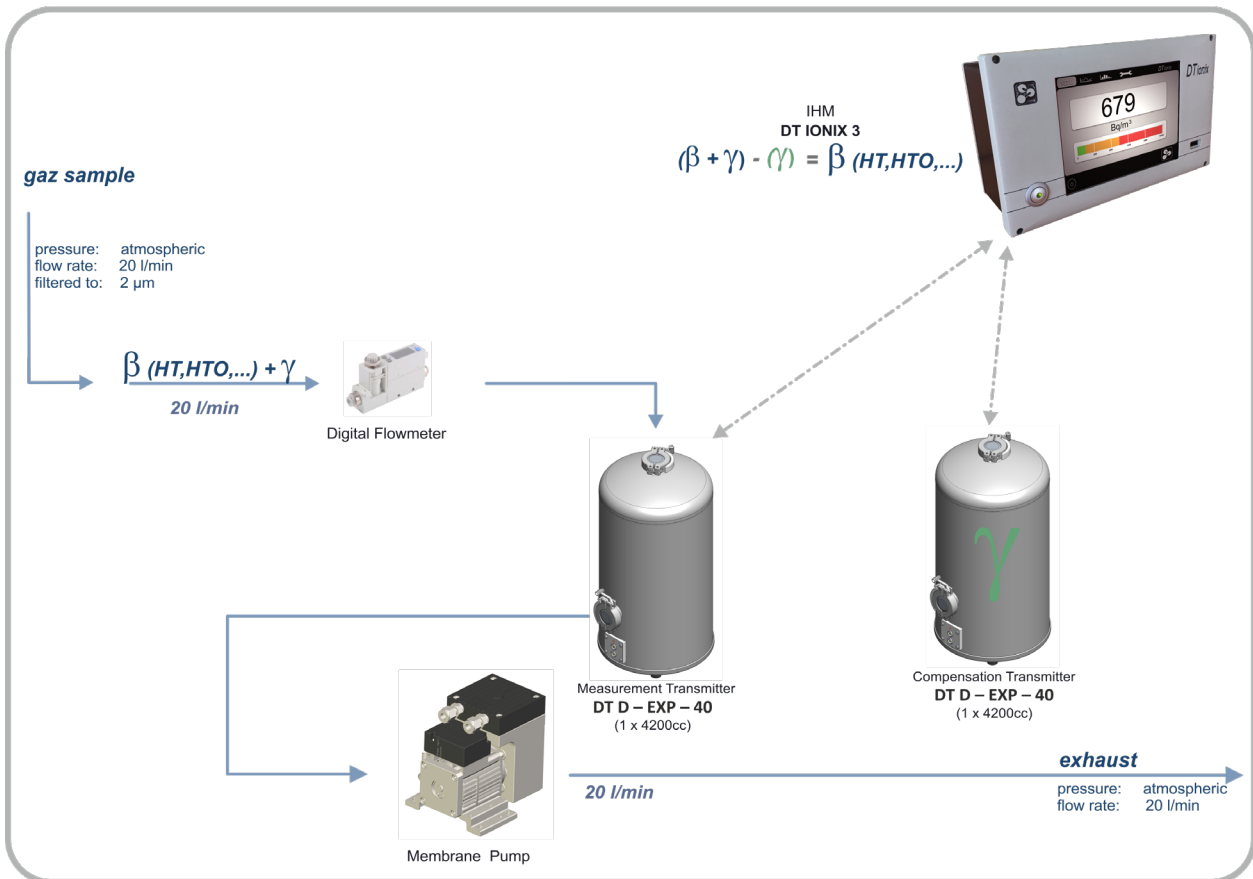
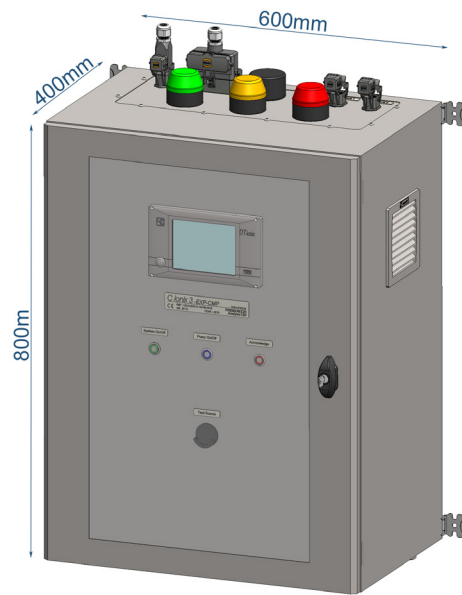

Fluid schematic for a C IONIX 3 - EXC

# C IONIX™ - EXX INSTALLED TRITIUM MONITOR

## UNIT CONFIGURATION AND PART NUMBERS

MONITOR CONFIGURATION AND OPTIONS CHOICE		
Measurement	Manual gamma compensation	<b>C IONIX 3 - EXM - 0 - 00 - 00 - FA - F</b>
	Automatic gamma compensation	<b>C IONIX 3 - EXC - 0 - 00 - 00 - FA - F</b>
Power distribution	24V power supply	<b>C IONIX 3 - EXX - 2 - XX - XX - FA - F</b>
	AC power supply	<b>C IONIX 3 - EXX - V - XX - XX - FA - F</b>
Alarms	Without light and sound	<b>C IONIX 3 - EXX - X - 0X - XX - FA - F</b>
	Local alarms (G / R / O + sound)	<b>C IONIX 3 - EXX - X - YX - XX - FA - F</b>
	Remote beacon connector	<b>C IONIX 3 - EXX - X - XB - XX - FA - F</b>
Connections	Process outputs (dry-contacts, 4-20mA, flow input)	<b>C IONIX 3 - EXX - X - XX - PX - FA - F</b>
	Modbus TCP-IP	<b>C IONIX 3 - EXX - X - XX - XM - FA - F</b>
Label	English	<b>C IONIX - EXX - X - XX - XX - FA - E</b>
	French	<b>C IONIX - EXX - X - XX - XX - FA - F</b>
Reference example	C ionix monitor full option with automatic gamma compensation	<b>C IONIX - EXC - V - YB - PM - FA - F</b>



ACCESSORIES	
2µ anti-dust filter + Stäubli	<b>ACC F2T S</b>
2µ anti-dust filter + Silencer	<b>ACC F2T</b>
Installed alarm beacon	<b>CX3 ACC BAL F</b>
Gas connector with silencer	<b>ACC ARG SIL</b>
Gas connector for 8 mm hose	<b>ACC ARG S08</b>
Mobile support 1 C ionix - EXX	<b>CEX3 ACC CHM 01</b>

CONSUMABLES	
Maintenance kit for pump (*x1/2)	<b>SP KIT N838</b>
Spare pump (*x1/2)	<b>CEX3 SP PPE</b>
DT ionix axial fan (x1*)	<b>SP 412F</b>
DT ionix axial fan mounted on support (x1*)	<b>SP 412F P</b>
Cabinet fan (x1*)	<b>SP 4314</b>
IP55 filter (*x2)	<b>SP 60715 187</b>
HEPA filter (*x1)	<b>SP CFL THE</b>
2µ filter (*x1)	<b>SP 90F0002</b>
O-ring (*x1)	<b>SP 90F0040</b>
Flat seal (*x1)	<b>SP 90F0048</b>

\* quantity needed for annual maintenance of monitor



Copyright © 2025 Mirion Technologies, Inc. or its affiliates. All rights reserved. Mirion, the Mirion logo, and other trade names of Mirion products listed herein are registered trademarks or trademarks of Mirion Technologies, Inc. or its affiliates in the United States and other countries. Third party trademarks mentioned are the property of their respective owners.



PREMIUM ANALYSE™

# M ionix 3™

## Mobile Tritium Monitor



Mobile tritium detector for radioprotection, process monitoring, environmental monitoring, laboratory, decommissioning job surveillance,...

### DESCRIPTION

The M ionix 3 monitors have been designed for the real-time monitoring of tritium and other  $\beta$  emitters in gases.

Thanks to their high sensitivity and their reliability, the M ionix 3 mobile monitors provide a continuous monitoring for the surveillance, ensuring the radiological protection for the teams on site. Their versatility also allows them to be used as a temporary replacement of fixed monitors.

The M ionix 3 benefit from some of the most advanced technologies developed by Mirion Technologies (PREMIUM Analyse):

- HEPA filtration system
- DT ionix™ interface with digital touchscreen
- Beta activity transmitter EXP40™ with low noise preamplifier

Ready to use, the M ionix mobile monitors offer some of the most advanced features, such as: graphical plotting of measurements, archiving of data, remote display of the alarm statuses, data extraction via USB,...

### FEATURES

#### ✓ High performance

- Self-checking
- Continuous measurement
- Response time under 3 min
- Integrated light and sound alarms
- Capability for automatic  $\gamma$  compensation
- Detection of tritium from 20 kBq/m<sup>3</sup> (0.5  $\mu$ Ci/m<sup>3</sup>)

#### ✓ Easy to use

- Ready to install
- Minimal intervention
- User-friendly interface

#### ✓ Mobile

- Lifting rings
- Carrying handles
- Rugged aluminum casing
- Easily movable on various surfaces

## M IONIX 3™ MOBILE TRITIUM MONITOR

### TECHNICAL CHARACTERISTICS

The mobile M ionix 3 monitors are available in several versions.

The versions below are intended for real-time and continuous measurement of tritium activity and other  $\beta$  emitters in gases:

Measurement characteristics in laboratory conditions (for tritium)	M IONIX 3 - X0 Tritium monitor with manual gamma compensation	M IONIX 3 - XC Tritium monitor with automatic gamma compensation
Measurement range of the electronics	2.1 kBq/m <sup>3</sup> to 2.1 TBq/m <sup>3</sup> 54 nCi/m <sup>3</sup> to 54 Ci/m <sup>3</sup>	2.1 kBq/m <sup>3</sup> to 2.1 TBq/m <sup>3</sup> 54 nCi/m <sup>3</sup> to 54 Ci/m <sup>3</sup>
Limit of detection of the device (2 $\sigma$ )	12.5 kBq/m <sup>3</sup> (0.33 $\mu$ Ci/m <sup>3</sup> )	20 kBq/m <sup>3</sup> (0.54 $\mu$ Ci/m <sup>3</sup> )
Precision	5% of the measurement $\pm$ 12.5 kBq/m <sup>3</sup> $\pm$ 0.33 $\mu$ Ci/m <sup>3</sup>	5% of the measurement $\pm$ 20 kBq/m <sup>3</sup> $\pm$ 0.54 $\mu$ Ci/m <sup>3</sup>
Maximum deviation	12.5 kBq/m <sup>3</sup> /year 0.33 $\mu$ Ci/m <sup>3</sup> /year	20 kBq/m <sup>3</sup> /year 0.54 $\mu$ Ci/m <sup>3</sup> /year
Noise (2 $\sigma$ )	$\pm$ 12.5 kBq/m <sup>3</sup> $\pm$ 0.33 $\mu$ Ci/m <sup>3</sup>	$\pm$ 20 kBq/m <sup>3</sup> $\pm$ 0.54 $\mu$ Ci/m <sup>3</sup>
Response time	< 3 min at 90% of step	
Ionization chamber(s)		
Volume	4 200 cc	2 x 4 200 cc
Nominal flow rate	20 L/m	

### OPERATING CONDITIONS

- Humidity: < 95% relative, no condensation
- Operating temperature: +0 °C to +40 °C (+32 °F to 104 °F)
- Influence of humidity:  $\pm$  1 % of the measurement from 10 to 90% of relative humidity
- Influence of temperature: 0.3%/°C for a variation of the ambient temperature < 3°C/hour
- Influence of atmospheric pressure: 0.1 %/mbar, hence  $\pm$  5 % of the measurement from 930 to 1030 mbar

### COMMON CHARACTERISTICS

Each unit integrates a DT ionix 3 digital touch interface allowing local viewing of data through an intuitive menu:

- Low flow detection
- 4 customizable alarm thresholds
- Digital display of volumetric activity
- Archiving of last 32 days of measurements
- Data extraction and system update via USB stick
- Graphical plotting of measurements and alarm values on a scale from 8 minutes to 8 days
- Choice of volumetric activity among 15 units, with 4 customizable ones (Bq/m<sup>3</sup>, RCA, DAC, Ci/m<sup>3</sup>...)
- Light and sound signals when pre-alarm (orange) and alarm (red) thresholds are exceeded, as well as good operation default.



# M IONIX 3™ MOBILE TRITIUM MONITOR

## POSSIBLE CONFIGURATIONS

- Global characteristics:
  - Dimensions: W 600 x H 1000 x d 500 mm (23.6 x 39.4 x 19.7")
  - Weight (approx.): 70 kg (154 lb)
  - Gas I/O via self-sealing Stäubli connectors
  - Alarms: 2 beacon outputs (24 V / 80 mA per signal)
  - Network: Ethernet Modbus connection via RJ45 connector
  - Process: dry-contacts available
- Electrical characteristics:
  - Max power: 120 W
  - Power supply: 85 - 264VAC, 50/60Hz
  - Electrical protection: 6A differential breaker with C curve
- Optional feature:
  - Remote alarm beacon
- Filtration:
  - "FX": 20µ anti-dust filtration
  - "TX": High efficiency HEPA filtration
- Measurement:
  - "X0": With flowmeter and simple measurement
  - "XC": With flowmeter and compensation chamber for automatic  $\gamma$  compensation

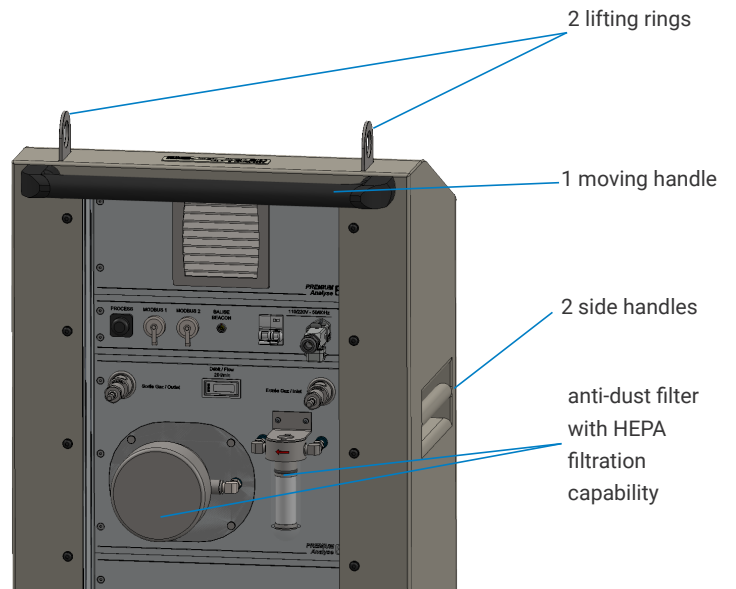

**TX Version**

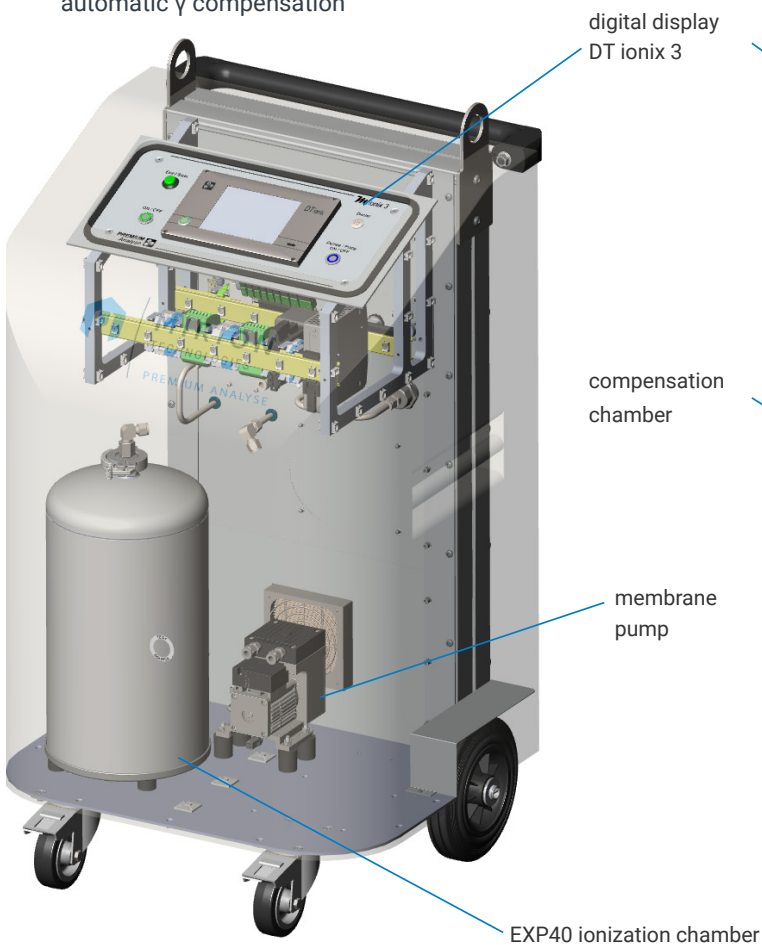

**X0 Version**

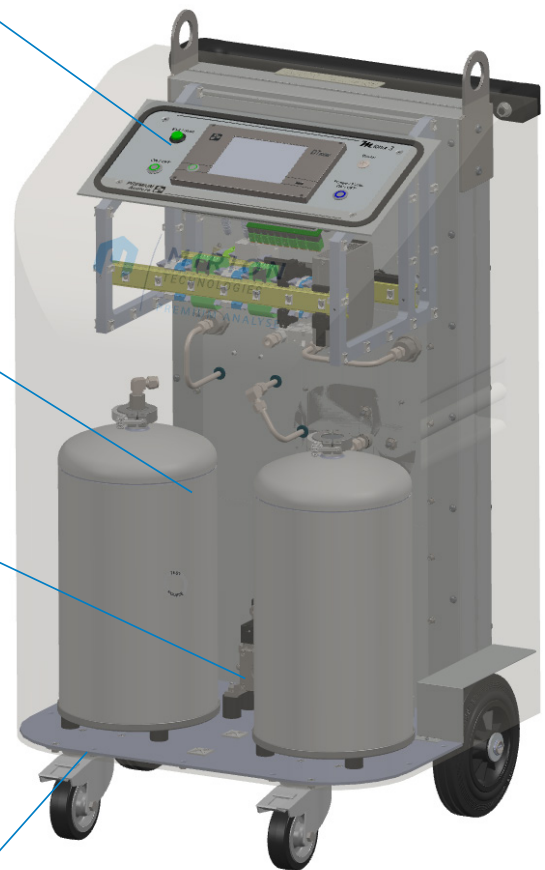

**XC Version**

# M IONIX 3™ MOBILE TRITIUM MONITOR

## ACCESSORIES AND PART NUMBERS

MONITOR CONFIGURATION AND OPTIONS		
Measurement		M IONIX 3 - X0 M IONIX 3 - XC
Filtration	Anti-dust filter HEPA filter	M IONIX 3 - FX M IONIX 3 - TX
Measurement type	With direct measurement With compensation chamber	M IONIX 3 - X0 M IONIX 3 - XC
Reference example	M ionix mobile tritium monitor with anti-dust filtration, gamma compensation, pump, integrated digital flowmeter and compensation chamber	M IONIX 3 - FC

ACCESSORIES	
Portable alarm beacon	ACC BAL P
Gas connector for 8 mm hose	ACC ARG S08
5 m sampling hose	MIX ACC TUY 05 S
10 m sampling hose	MIX ACC TUY 10 S

CONSUMABLES	
M ionix 3 pump	MX3 SP PPE
Maintenance kit for pump	SP - KITMAINT N838
Teflon filter 2 µ	SP 90F0002
Viton o-ring type 26	SP 90F0040
HEPA filter	SP 32051100
Ventilation filter	SP 0715 187 (x 2 required)
DT ionix axial fan	SP 412F
DT ionix axial fan mounted on support	SP 412F P
Case fan	SP 4314



Copyright © 2025 Mirion Technologies, Inc. or its affiliates. All rights reserved. Mirion, the Mirion logo, and other trade names of Mirion products listed herein are registered trademarks or trademarks of Mirion Technologies, Inc. or its affiliates in the United States and other countries. Third party trademarks mentioned are the property of their respective owners.



PREMIUM ANALYSE™

# DT ionix™

## Human-Machine Interface



Human-Machine Interface integrated to all of tritium detection channels manufactured by Mirion Technologies (Premium Analyse), either mobile, installed or custom.

### DESCRIPTION

The DT ionix 3 Human-Machine Interface has been designed to handle, manage and analyze digital signals from all of our tritium detectors.

The DT ionix 3 allows for acquisition, digitalization and display of information and data from one or two preamplifier(s).

Thanks to several 4-20mA analogue inputs and outputs, dry-contacts and 2 Modbus outputs, it can handle all types of signals and carry them over, as well as measurement signals, to a supervision.

### FEATURES

- ✓ **User-friendly**
  - Intuitive design
  - Colour touchscreen
  - Graphic and numerical display
- ✓ **Advanced features**
  - Real-time volumetric activity display
  - Remote data reading and device monitoring via Modbus
  - Data saved on internal memory, can be copied onto USB
- ✓ **Connected**
  - Modbus TCP/IP connection
  - 4/20mA analogue outputs
  - 5 dry-contact outputs with customizable alarm thresholds
  - 32 days of data acquisition and export of data via USB



# DT IONIX™ HUMAN-MACHINE INTERFACE

## CHARACTERISTICS

- Weight: 1.8 kg (4 lb)
- Dimensions: 9½" drawer (213 mm) x 3U (128.42 mm) x 81 mm
- Power supply: 9 to 36Vdc – 30W
- Mains connector: 110/220V – 50/60Hz – 12VDC – 180W (supplied)
- Humidity: < 95% relative, without condensation
- Temperature of use: from -10 to +40 °C (14 to 104 °F)
- Axial fan, 8 m³/h, easily replaceable

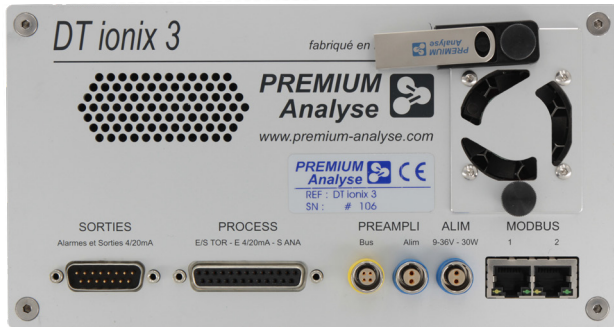

## FEATURES

- 4 customizable alarm thresholds
- Digital display of volumetric activity
- Colour touchscreen with intuitive menus
- 32 days of measurement data archived in spreadsheet format
- Data extraction and system update via USB
- Display of volumetric activity with bar chart showing alarm thresholds
- Possibility for manual offset for gamma compensation and external influences
- Graphic plotting of measurements and alarm values from 8 minutes to 8 days
- Adjustment and monitoring of the flow rate with capability to detect low flow
- Capability for differential measurement (with reference or gamma compensation detector)
- Choice of volumetric activity among 15 units, with 4 customizable ones (Bq/m³, RCA, DAC, Ci/m³...)
- Light and sound signals when pre-alarm (orange) and alarm (red) thresholds are exceeded, as well as default operation

- Histogram of integrated activities, on 1h, 1 day, 1 month taking the flow in consideration, triggered locally or from the supervision
- Configuration, visualization of state and testing detector, alarms, inputs/outputs etc via Modbus protocol (2 independent connections)

## INPUTS/OUTPUTS

- Connection for 1 or 2 high resolution preamplifier (power supply and communication)
- 2 x 4-20 mA analogue inputs customizable
- 2 x 4-20 mA analogue outputs customizable
- 5 dry-contact 24V/1A outputs (green, orange, red, sound, proper functioning)
- 4 output signals 24V/100mA for the management of G/Y/R and sound alarms
- 2 pump control outputs
- Data extraction via front panel USB port
- 2 Modbus / TCP-IP Ethernet connections



Copyright © 2025 Mirion Technologies, Inc. or its affiliates. All rights reserved. Mirion, the Mirion logo, and other trade names of Mirion products listed herein are registered trademarks or trademarks of Mirion Technologies, Inc. or its affiliates in the United States and other countries. Third party trademarks mentioned are the property of their respective owners.



PREMIUM ANALYSE™

# DT D - MC10™

## 10 cc Tritium Detector

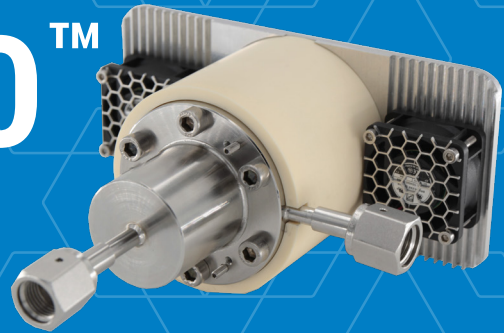

Ionization chamber for the measurement of high tritium activities in research applications, laboratories and process monitoring. Due to its heating resistance, the detector can easily be decontaminated.

### DESCRIPTION

The DT D - MC10 unit is a small size ionization chamber (10 cc) detector allowing the measurement of high tritium activity in gases from  $190 \text{ kBq/m}^3$  ( $5.13 \mu\text{Ci/m}^3$ ) to  $19 \text{ PBq/m}^3$  ( $513 \text{ kCi/m}^3$ ).

This detector has been designed for civil and military research applications and process monitoring, as well as specific projects such as ITER involving high quantities of tritium where measurement of high activities is needed

Due to its heating resistance, the detector can be baked in order to be decontaminated.

The detector is connected to a DT ionix 3™ touchscreen Human Machine Interface via the preamplifier that can be installed several hundred meters away from the detector. Thanks to that, it benefits from the most advanced features such as graphical data plotting, data extraction via USB, Modbus communication, dry contact outputs...

*Device manufactured under exploitation licence for CEA patent - L26218  
Device registered as dual-use n°1B231 regulation (CE) 2021/821 Appendix IV*

### FEATURES

- ✓ **High performance**
  - Continuous measurement
  - Wide measurement range
  - Response time under 90 seconds
- ✓ **Simple**
  - Easy maintenance
  - Quick and easy set up
- ✓ **Reliable**
  - Decontaminable
  - Precise and stable

## DT D - MC10™ 10 CC TRITIUM DETECTOR

### GENERAL CHARACTERISTICS

- Dimensions: 200 x 80 x 200 mm (w x h x d)
- Weight: 1,800 g
- Gas connection 1/4" VCR, silver plated gaskets.
- Leak rate less than  $1.10^{-11}$  mbar.L.s<sup>-1</sup>

### HEATING RESISTANCE

- Heating resistance: 220V - 400 W
- Thermocouple connector: female connector for type J thermocouple on regulator
- Power supply: 220V / 50Hz IEC baseplate C14, integrated mains filter, 2x2A 5x20mm fuses for shortcut protection
- Heating resistance connector: 3 pins Ampenol baseplate. Delivered with additional connectors for extension cable
- Fan on dissipator powered by ACC ALIM 24V E (supplied)

### IONIZATION CHAMBER

- Material: electropolished 316L stainless steel
- Ionizing volume: 9.28 cc
- Circulation chamber: 48 cc
- Mechanical pressure: 10 bars abs

### OPERATING CONDITIONS

- Humidity: dry carrying gas
- Baking temperature: up to 500°C continuously
- Operating temperature: +0 °C to +40 °C (+32 °F to 104 °F)
- Influence of humidity: ± 1% of the measurement from 10 to 90% of relative humidity
- Influence of temperature: 0.3%/°C for a variation of the ambient temperature < 3°C/hour
- Influence of atmospheric pressure: 0.1%/mbar, hence ± 5% of the measurement from 930 to 1030 mbar

### PERFORMANCES (For tritium in air, lab conditions)

Associated preamp	DT P - LN - 1B8	DT P - LN - 1A7	DT P - LN - 196
Measurement range of the electronics	190 kBq/m <sup>3</sup> to 190 TBq/m <sup>3</sup> 5.13 μCi/m <sup>3</sup> to 5.13 kCi/m <sup>3</sup>	1.9 MBq/m <sup>3</sup> to 1.9 PBq/m <sup>3</sup> 51.3 μCi/m <sup>3</sup> to 51.3 kCi/m <sup>3</sup>	19 MBq/m <sup>3</sup> to 19 PBq/m <sup>3</sup> 513 μCi/m <sup>3</sup> to 513 kCi/m <sup>3</sup>
Limit of detection of the device (2σ)	1 MBq/m <sup>3</sup> 27 μCi/m <sup>3</sup>	5 MBq/m <sup>3</sup> 135 μCi/m <sup>3</sup>	25 MBq/m <sup>3</sup> 675 μCi/m <sup>3</sup>
Precision	5% of measurement ± 1 MBq/m <sup>3</sup> ± 27 μCi/m <sup>3</sup>	5% of measurement ± 5 MBq/m <sup>3</sup> ± 135 μCi/m <sup>3</sup>	5% of measurement ± 25 MBq/m <sup>3</sup> ± 675 μCi/m <sup>3</sup>
Maximum deviation	1 MBq/m <sup>3</sup> /year 27 μCi/m <sup>3</sup> /year	5 MBq/m <sup>3</sup> /year 135 μCi/m <sup>3</sup> /year	25 MBq/m <sup>3</sup> /year 675 μCi/m <sup>3</sup> /year
Noise (2σ)	1 MBq/m <sup>3</sup> (27 μCi/m <sup>3</sup> )	5 MBq/m <sup>3</sup> (135 μCi/m <sup>3</sup> )	25 MBq/m <sup>3</sup> (675 μCi/m <sup>3</sup> )
Response time	< 90 sec for 90% of step		
Nominal flow rate	250 cc/min		

### INTEGRATION OF DETECTOR IN MEASUREMENT CHANNEL

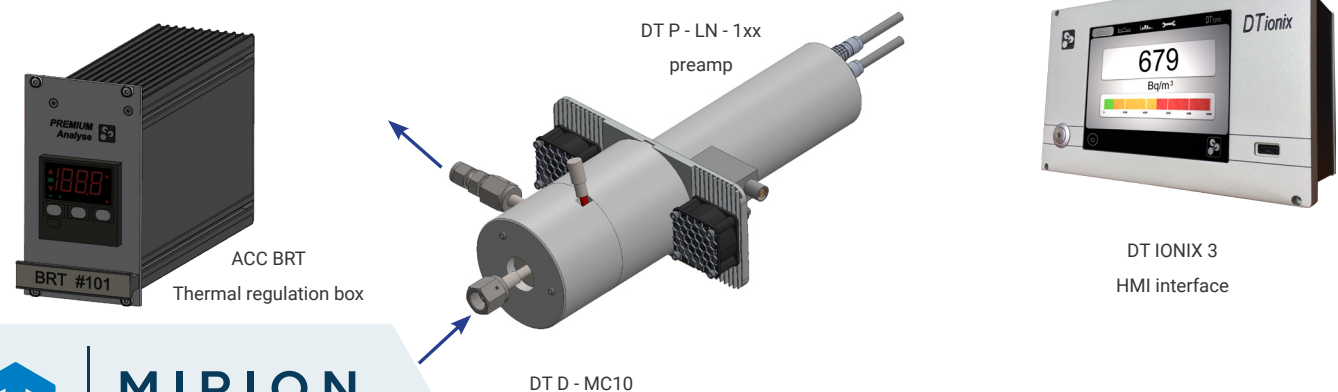

Copyright © 2025 Mirion Technologies, Inc. or its affiliates. All rights reserved. Mirion, the Mirion logo, and other trade names of Mirion products listed herein are registered trademarks or trademarks of Mirion Technologies, Inc. or its affiliates in the United States and other countries. Third party trademarks mentioned are the property of their respective owners.



PREMIUM ANALYSE™

# DT D - MLB™

## Tritium Detector

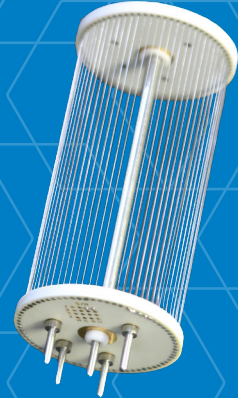

Ionization chamber for the detection and measurement of high activities for research application in laboratories and for the control of gloveboxes ambiance.

### DESCRIPTION

The DT D - MLB detector is a small size ionization chamber (100 cc) allowing the measurement of high tritium activities in gases from 21 kBq/m<sup>3</sup> (0.57 µCi/m<sup>3</sup>) to 2.1 PBq/m<sup>3</sup> (56.7 kCi/m<sup>3</sup>).

This detector has been designed for civil and military research applications, as well as specific projects such as ITER, needing measurement of high activities.

Thanks to a mounting on a leak-tight feedthroughs, it can be installed on gloveboxes outlet. It does not necessarily require an additional pump as it is usually mounted directly in the gas flow to be analyzed.

The detector is connected to a DT ionix 3™ touchscreen Human Machine Interface via the preamplifier that can be installed several hundred meters away from the detector. Thanks to that, it benefits from the most advanced features such as graphical data plotting, data extraction via USB, Modbus communication, dry contact outputs...

*Device manufactured under exploitation licence for CEA patent - L26218  
Device registered as dual-use n°1B231 regulation (CE) 2021/821 Appendix IV*

### FEATURES

- ✓ **High performance**
  - Continuous measurement
  - Wide measurement range
  - Response time under 90 seconds
- ✓ **Simple**
  - Easy maintenance
  - Quick and easy set up
- ✓ **Reliable**
  - Precise and stable

## DT D - MLB™ TRITIUM DETECTOR

### GENERAL CHARACTERISTICS

- Dimensions: Ø 43 x 100 mm
- Weight: 30 g

### MOUNTING

- Mounting on leak-tight feedthroughs:
  - Flanged (ref: DT PE - B160L/DT PE - B180L)
  - Adjustable (ref: DT PE - BTE)
  - Straight (ref: DT PE - BTD)
- Mounting in circulation chamber:
  - 380 cc (ref: MLB ACC CC2)
  - 785 cc (ref: ACC CCG 800)
  - 1 400 cc (ref: ACC CCG 1400)

### IONIZATION CHAMBER

- Materials: 316L stainless steel - ceramic - teflon
- Ionization volume: 100 cc
- Circulation volume: depending on mounting

### OPERATING CONDITIONS

- Humidity: < 95% relative, no condensation
- Operating temperature: +0 °C to +40 °C (+32 °F to 104 °F)
- Influence of humidity: ± 1% of the measurement from 10 to 90% of relative humidity
- Influence of temperature: 0.3%/°C for a variation of the ambient temperature < 3 °C/hour
- Influence of atmospheric pressure: 0.1%/mbar, hence ± 5% of the measurement from 930 to 1030 mbar

### PERFORMANCES (For tritium in air, lab conditions)

Associated preamp	DT P - LN - 1B8	DT P - LN - 1A7	DT P - LN - 196
<b>Measurement range of the electronics</b>	21 kBq/m <sup>3</sup> to 21 TBq/m <sup>3</sup> 0.57 µCi/m <sup>3</sup> to 567 Ci/m <sup>3</sup>	210 kBq/m <sup>3</sup> to 210 TBq/m <sup>3</sup> 5.67 µCi/m <sup>3</sup> to 5.67 kCi/m <sup>3</sup>	2.1 MBq/m <sup>3</sup> to 2.1 PBq/m <sup>3</sup> 56.7 µCi/m <sup>3</sup> to 56.7 kCi/m <sup>3</sup>
<b>Limit of detection of the device (2σ)</b>	100 kBq/m <sup>3</sup> 2.7 µCi/m <sup>3</sup>	250 kBq/m <sup>3</sup> 6.7 µCi/m <sup>3</sup>	3 MBq/m <sup>3</sup> 81.1 µCi/m <sup>3</sup>
<b>Precision</b>	5% of measurement ± 100 kBq/m <sup>3</sup> ± 2.7 µCi/m <sup>3</sup>	5% of measurement ± 250 kBq/m <sup>3</sup> ± 6.7 µCi/m <sup>3</sup>	5% of measurement ± 3 MBq/m <sup>3</sup> ± 81.1 µCi/m <sup>3</sup>
<b>Maximum deviation</b>	100 kBq/m <sup>3</sup> /year 2.7 µCi/m <sup>3</sup> /year	250 kBq/m <sup>3</sup> /year 6.7 µCi/m <sup>3</sup> /year	3 MBq/m <sup>3</sup> /year 81.1 µCi/m <sup>3</sup> /year
<b>Noise (2σ)</b>	100 kBq/m <sup>3</sup> (2.7 µCi/m <sup>3</sup> )	250 kBq/m <sup>3</sup> (6.7 µCi/m <sup>3</sup> )	3 MBq/m <sup>3</sup> (81.1 µCi/m <sup>3</sup> )
<b>Response time</b>	< 90 sec for 90% of step		

### INTEGRATION OF DETECTOR IN MEASUREMENT CHANNEL

(example of integration)

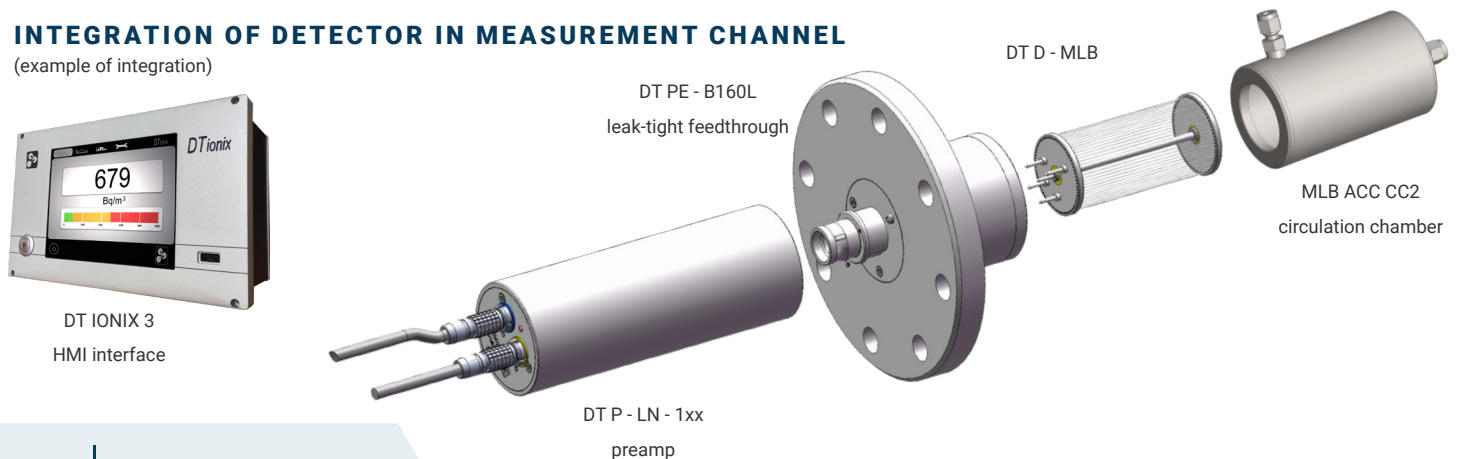

Copyright © 2025 Mirion Technologies, Inc. or its affiliates. All rights reserved. Mirion, the Mirion logo, and other trade names of Mirion products listed herein are registered trademarks or trademarks of Mirion Technologies, Inc. or its affiliates in the United States and other countries. Third party trademarks mentioned are the property of their respective owners.



PREMIUM ANALYSE™

# DT D - BL2™

## 2 x 195 cc Tritium Detector

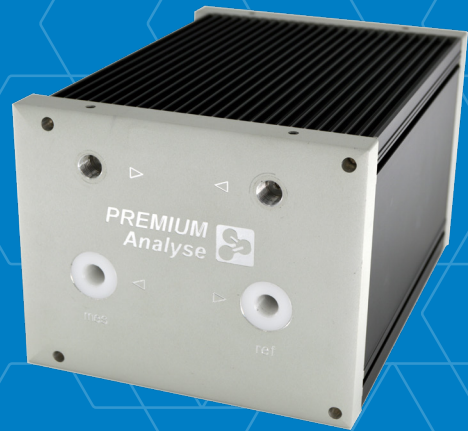

Ionization chamber for use in the field of radioprotection, environmental monitoring and process surveillance.

### DESCRIPTION

The DT D - BL2 unit is a medium size ionization chamber (2 x 195 cc) detector providing a wide measurement range from the kBq/m<sup>3</sup> (nCi/m<sup>3</sup>) to the TBq/m<sup>3</sup> (Ci/m<sup>3</sup>).

This complete housing detector which includes the ionization chamber as well as the preamplifier, is adapted for the measurement of all ranges of activity.

The detector is connected to a touchscreen DT ionix 3™ Human Machine Interface that can be installed several hundred meters away from the detector, providing the most advanced features such as graphical data plotting, data extraction via USB, Modbus communication and dry contact outputs.

### FEATURES

- ✓ **High performance**
  - Continuous measurement
  - Wide measurement range
  - Response time under 90 seconds
- ✓ **Simple**
  - Maintenance-free
  - Quick and easy commissioning
- ✓ **Reliable**
  - Precise and stable

## DT D - BL2™ 2 x 195 CC TRITIUM DETECTOR

### GENERAL CHARACTERISTICS

- Dimensions: 140 x 111 x 197 mm (W x H x D)
- Weight: 3 kg (6.6 lb)

### OPERATING CONDITIONS

- Temperature of use: +0 °C to +40 °C (+32 °F to +104 °F)
- Influence of temperature: 0.3%/°C for a variation of ambient temperature < 3°C/hour
- Humidity: < 95% relative, no condensation
- Influence of humidity: ± 1% of the measurement from 10 to 90% relative humidity
- Influence of atmospheric pressure: 0.1%/mbar, hence ± 5% of the measurement from 930 to 1030 mbar

### IONIZATION CHAMBER

- Material: 304 L stainless steel electropolished
- Volume: 2 x 195 cc



### PERFORMANCES (For tritium in air)

Configuration	CMP (dynamic $\gamma$ compensation)	DIF (ex: with SAM HTO)
Measurement range of the electronics	10 kBq/m <sup>3</sup> to 10 TBq/m <sup>3</sup> 0.27 $\mu$ Ci/m <sup>3</sup> to 270 Ci/m <sup>3</sup>	10 kBq/m <sup>3</sup> to 10 TBq/m <sup>3</sup> 0.27 $\mu$ Ci/m <sup>3</sup> to 270 Ci/m <sup>3</sup>
Limit of detection of the device (2 $\sigma$ ) = decision threshold	45 kBq/m <sup>3</sup> 1.22 $\mu$ Ci/m <sup>3</sup>	60 kBq/m <sup>3</sup> 1.62 $\mu$ Ci/m <sup>3</sup>
Precision	5% of measurement ± 45 kBq/m <sup>3</sup> ± 1.22 $\mu$ Ci/m <sup>3</sup>	5% of measurement ± 60 kBq/m <sup>3</sup> ± 1.62 $\mu$ Ci/m <sup>3</sup>
Variation max	45 kBq/m <sup>3</sup> /year (1.22 $\mu$ Ci/m <sup>3</sup> /year)	60 kBq/m <sup>3</sup> /year (1.62 $\mu$ Ci/m <sup>3</sup> /year)
Noise (2 $\sigma$ )	45 kBq/m <sup>3</sup> (1.22 $\mu$ Ci/m <sup>3</sup> )	60 kBq/m <sup>3</sup> (1.62 $\mu$ Ci/m <sup>3</sup> )
Response time	< 90 sec at 90% of step	
Nominal flow	2 x 1 L/min	

Injection of 1 MBq/m<sup>3</sup> (27  $\mu$ Ci/m<sup>3</sup>) tritium in the form of HT, then of 2 MBq/m<sup>3</sup> (54  $\mu$ Ci/m<sup>3</sup>) of tritium in the form of HTO. The injection of HT is then stopped and finally the injection of HTO is stopped.



Copyright © 2025 Mirion Technologies, Inc. or its affiliates. All rights reserved. Mirion, the Mirion logo, and other trade names of Mirion products listed herein are registered trademarks or trademarks of Mirion Technologies, Inc. or its affiliates in the United States and other countries. Third party trademarks mentioned are the property of their respective owners.



PREMIUM ANALYSE™

# DT D - IC500™

## 500 cc Tritium Detector



Ionization chamber for the detection and measurement of high activities for research application in laboratories and for the control of glovebox ambiance.

### DESCRIPTION

The DT D - IC500 detector is a medium-sized ionization chamber (500 cc) allowing the measurement of high tritium activities in gases from  $3.8 \text{ kBq/m}^3$  ( $0.103 \text{ } \mu\text{Ci/m}^3$ ) to  $3.8 \text{ TBq/m}^3$  ( $103 \text{ Ci/m}^3$ ).

This detector has been designed for research applications, as well as specific projects such as ITER where measurement of high activities is potentially needed.

Mounted on leak-tight feedthroughs, it can be installed on glovebox outlet. It does not generally require an additional pump as it is usually mounted directly in the gas flow to be analyzed.

The detector is connected to a DT ionix 3™ touchscreen Human Machine Interface via the preamplifier that can be installed several hundred meters away from the detector. Thanks to that, it benefits from the most advanced features such as graphical data plotting, data extraction via USB, Modbus communication, dry contact outputs...

### FEATURES

- ✓ **High performance**
  - Continuous measurement
  - Wide measurement range
  - Response time from 30 seconds
- ✓ **Simple**
  - Easy maintenance
  - Quick and easy set up
- ✓ **Reliable**
  - Precise and stable



## DT D - IC500™ 500 CC TRITIUM DETECTOR

### GENERAL CHARACTERISTICS

- Dimensions: Ø 67 x 157 mm
- Weight: 300 g

### MOUNTING

- Mounting on leak-tight feedthroughs:
  - Flanged (ref: DT PE - B160L/DT PE - B180L)
  - Adjustable (ref: DT PE - BTE)
  - Straight (ref: DT PE - BTD)
- Mounting in circulation chamber:
  - 1 400 cc (ref: ACC CCG 1400)

### IONIZATION CHAMBER

- Materials: 316L stainless steel - DELRIN - brass
- Ionization volume: 500 cc

### OPERATING CONDITIONS

- Humidity: < 95% relative, no condensation
- Operating temperature: +0 °C to +40 °C (+32 °F to 104 °F)
- Influence of humidity: ± 1% of the measurement from 10 to 90% of relative humidity
- Influence of temperature: 0.3%/°C for a variation of the ambient temperature < 3 °C/hour
- Influence of atmospheric pressure: 0.1%/mbar, hence ± 5% of the measurement from 930 to 1030 mbar

### PERFORMANCES (For tritium in air, lab conditions)

Associated preamp	DT P - LN - 1B8	DT P - LN - 1A7	DT P - LN - 196
<b>Measurement range of the electronics</b>	3.8 kBq/m <sup>3</sup> to 3.8 TBq/m <sup>3</sup> 103 µCi/m <sup>3</sup> to 103 Ci/m <sup>3</sup>	210 kBq/m <sup>3</sup> to 210 TBq/m <sup>3</sup> 5.67 µCi/m <sup>3</sup> to 5.67 kCi/m <sup>3</sup>	2.1 MBq/m <sup>3</sup> to 2.1 PBq/m <sup>3</sup> 56.7 µCi/m <sup>3</sup> to 56.7 kCi/m <sup>3</sup>
<b>Limit of detection of the device (2σ)</b>	30 kBq/m <sup>3</sup> 0.8 µCi/m <sup>3</sup>	75 kBq/m <sup>3</sup> 2 µCi/m <sup>3</sup>	3 MBq/m <sup>3</sup> 81.1 µCi/m <sup>3</sup>
<b>Precision</b>	5% of measurement ± 30 kBq/m <sup>3</sup> ± 0.8 µCi/m <sup>3</sup>	5% of measurement ± 75 kBq/m <sup>3</sup> ± 2 µCi/m <sup>3</sup>	5% of measurement ± 500 kBq/m <sup>3</sup> ± 13.5 µCi/m <sup>3</sup>
<b>Maximum deviation</b>	30 kBq/m <sup>3</sup> /year 0.8 µCi/m <sup>3</sup> /year	75 kBq/m <sup>3</sup> /year 2 µCi/m <sup>3</sup> /year	500 kBq/m <sup>3</sup> /year 13.5 µCi/m <sup>3</sup> /year
<b>Noise (2σ)</b>	30 kBq/m <sup>3</sup> (0.8 µCi/m <sup>3</sup> )	75 kBq/m <sup>3</sup> (2 µCi/m <sup>3</sup> )	500 kBq/m <sup>3</sup> (13.5 µCi/m <sup>3</sup> )
<b>Response time</b>	< 120 s for 90% of step	< 120 s for 90% of step	< 30 s for 90% of step

### INTEGRATION OF DETECTOR IN MEASUREMENT CHANNEL

(example of integration)

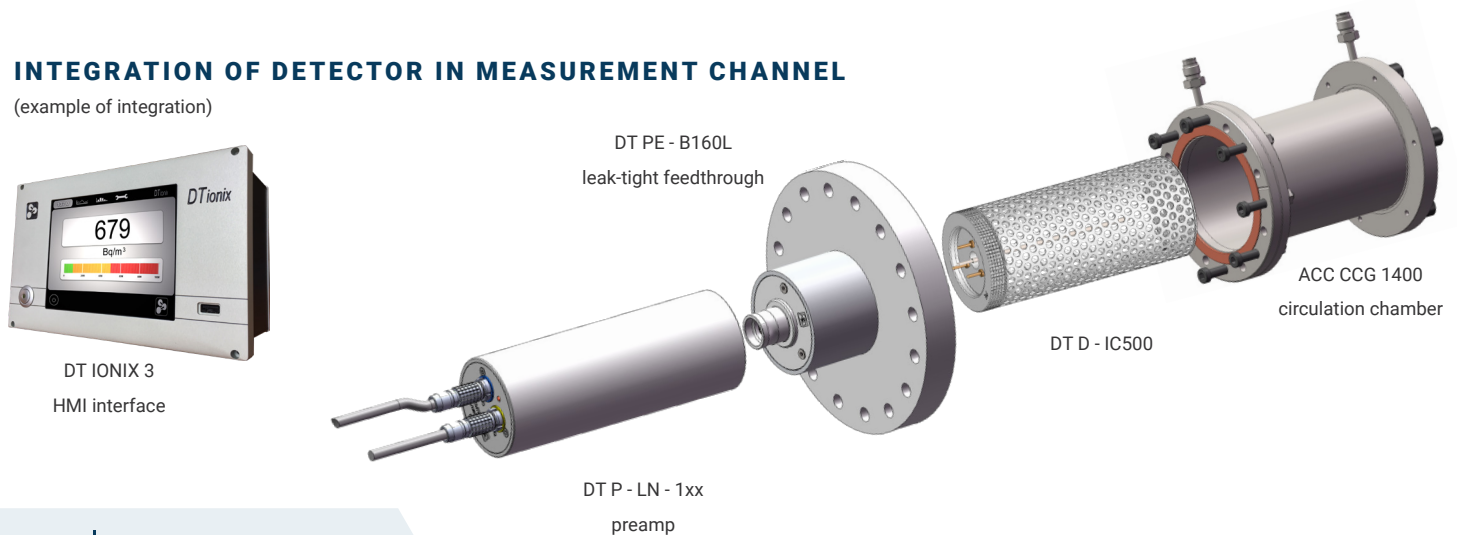

Copyright © 2025 Mirion Technologies, Inc. or its affiliates. All rights reserved. Mirion, the Mirion logo, and other trade names of Mirion products listed herein are registered trademarks or trademarks of Mirion Technologies, Inc. or its affiliates in the United States and other countries. Third party trademarks mentioned are the property of their respective owners.



PREMIUM ANALYSE™

# DT D - BM8™

## 660 cc Tritium Detector

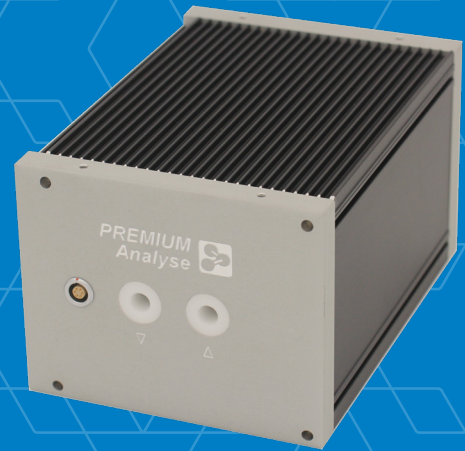

Ionization chamber for use in the field or radioprotection, environmental monitoring and process surveillance.

### DESCRIPTION

The DT D - BM8 detector is a medium-sized ionization chamber (660 cc) detector providing a wide measurement range from the 3.2 kBq/m<sup>3</sup> (86 nCi/m<sup>3</sup>) range to the 3.2 TBq/m<sup>3</sup> (86 Ci/m<sup>3</sup>) range.

This complete housing detector that includes the ionization chamber as well as the preamplifier is adapted for the measurement of all ranges of activity.

The detector is connected to a DT ionix 3™ touchscreen Human Machine Interface via the preamplifier that can be installed several hundred meters away from the detector. Thanks to that, it benefits from the most advanced features such as graphical data plotting, data extraction via USB, Modbus communication, dry contact outputs...

### FEATURES

- ✓ **High performance**
  - Continuous measurement
  - Wide measurement range
  - Response time below 90 seconds
- ✓ **Simple**
  - Maintenance-free
  - Quick and easy commissioning
- ✓ **Reliable**
  - Precise and stable

# DT D - BM8™ 660 CC TRITIUM DETECTOR

## GENERAL CHARACTERISTICS

- Dimensions: 139 x 112 x 140 mm (w x h x d)
- Weight: approx. 4 kg

## PERFORMANCES (For tritium in air, lab conditions)

Characteristics	BM8
Measurement range of the electronics	3.2 kBq/m <sup>3</sup> to 3.2 TBq/m <sup>3</sup> 86 µCi/m <sup>3</sup> to 86 Ci/m <sup>3</sup>
Limit of detection of the device (2σ)	20 kBq/m <sup>3</sup> 0.5 µCi/m <sup>3</sup>
Precision	5% of measurement ± 20 kBq/m <sup>3</sup> ± 0.5 µCi/m <sup>3</sup>
Maximum deviation	20 kBq/m <sup>3</sup> /year 0.5 µCi/m <sup>3</sup> /year
Noise (2σ)	20 kBq/m <sup>3</sup> (0.5 µCi/m <sup>3</sup> )
Response time	< 90 sec for 90% of step
Nominal flow rate	4 L/min

## IONIZATION CHAMBER

- Materials: 304L stainless steel electropolished
- Volume: 660 cc

## OPERATING CONDITIONS

- Humidity: < 95% relative, no condensation
- Operating temperature: +0 °C to +40 °C (+32 °F to 104 °F)
- Influence of humidity: ± 1% of the measurement from 10 to 90% of relative humidity
- Influence of temperature: 0.3%/°C for a variation of the ambient temperature < 3 °C/hour
- Influence of atmospheric pressure: 0.1%/mbar, hence ± 5% of the measurement from 930 to 1030 mbar



Calibration reports available, gas calibration made upon request

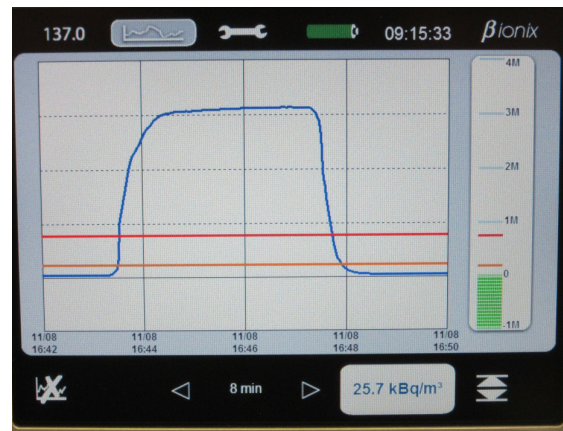

Response to a 3 MBq/m<sup>3</sup> (81 µCi/m<sup>3</sup>) gas injection



Response to a 1.6 MBq/m<sup>3</sup> (43 µCi/m<sup>3</sup>) gas injection



Copyright © 2025 Mirion Technologies, Inc. or its affiliates. All rights reserved. Mirion, the Mirion logo, and other trade names of Mirion products listed herein are registered trademarks or trademarks of Mirion Technologies, Inc. or its affiliates in the United States and other countries. Third party trademarks mentioned are the property of their respective owners.



PREMIUM ANALYSE™

# DT D - BM8 - HE™

## High Leak-tight 660 cc Tritium Detector



Ionization chamber for use in the field or radioprotection, environmental monitoring and process monitoring.

### DESCRIPTION

The DT D - BM8 - HE detector is a medium-sized ionization chamber (660 cc) detector providing a wide measurement range from the 3.2 kBq/m<sup>3</sup> (86 nCi/m<sup>3</sup>) range to the 3.2 TBq/m<sup>3</sup> (86 Ci/m<sup>3</sup>) range.

This complete housing detector that includes the ionization chamber as well as the preamplifier is adapted for the measurement of all ranges of activity

The detector is connected to a DT ionix 3™ touchscreen Human Machine Interface via the preamplifier that can be installed several hundred meters away from the detector. Thanks to that, it benefits from the most advanced features such as graphical data plotting, data extraction via USB, Modbus communication, dry contact outputs...

Thanks to its high leak-tightness it is completely adapted to the measurement of high activities without risk of potential leak.

### FEATURES

- ✓ **High performance**
  - Continuous measurement
  - Wide measurement range
  - Response time below 90 seconds
- ✓ **Simple**
  - Maintenance-free
  - Quick and easy commissioning
- ✓ **Reliable**
  - High leak-tight
  - Precise and stable

# DT D - BM8- HE™ HIGH LEAK-TIGHT 660 CC TRITIUM DETECTOR

## GENERAL CHARACTERISTICS

- Dimensions: 139 x 112 x 140 mm (w x h x d)
- Weight: approx. 4 kg

## PERFORMANCES (For tritium in air, lab conditions)

Characteristics	BM8
Measurement range of the electronics	3.2 kBq/m <sup>3</sup> to 3.2 TBq/m <sup>3</sup> 86 µCi/m <sup>3</sup> to 86 Ci/m <sup>3</sup>
Limit of detection of the device (2σ)	20 kBq/m <sup>3</sup> 0.5 µCi/m <sup>3</sup>
Precision	5% of measurement ± 20 kBq/m <sup>3</sup> ± 0.5 µCi/m <sup>3</sup>
Maximum deviation	20 kBq/m <sup>3</sup> /year 0.5 µCi/m <sup>3</sup> /year
Noise (2σ)	20 kBq/m <sup>3</sup> (0.5 µCi/m <sup>3</sup> )
Response time	< 90 sec for 90% of step
Nominal flow rate	4 L/min

## IONIZATION CHAMBER

- Materials: 304L stainless steel electropolished
- Volume: 660 cc
- Design pressure: 10 bars abs

## OPERATING CONDITIONS

- Humidity: < 95% relative, no condensation
- Operating temperature: +0 °C to +40 °C (+32 °F to 104 °F)
- Influence of humidity: ± 1% of the measurement from 10 to 90% of relative humidity
- Influence of temperature: 0.3%/°C for a variation of the ambient temperature < 3 °C/hour
- Influence of atmospheric pressure: 0.1%/mbar, hence ± 5% of the measurement from 930 to 1030 mbar



Calibration reports available, gas calibration made upon request



Leak rate < 1 . 10<sup>-6</sup> mbar.L.s<sup>-1</sup> (He)

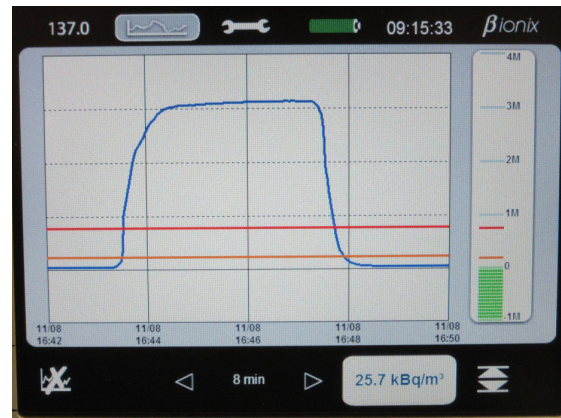

Response to a 3 MBq/m<sup>3</sup> (81 µCi/m<sup>3</sup>) gas injection



Copyright © 2025 Mirion Technologies, Inc. or its affiliates. All rights reserved. Mirion, the Mirion logo, and other trade names of Mirion products listed herein are registered trademarks or trademarks of Mirion Technologies, Inc. or its affiliates in the United States and other countries. Third party trademarks mentioned are the property of their respective owners.



PREMIUM ANALYSE™

# DT D - EXP40™

## 4 200 cc Tritium Detector



4L ionization chamber for use in the field or radioprotection, environmental monitoring, process control, laboratory and decommissioning surveillance.

### DESCRIPTION

The DT D - EXP40 detector is an important-volume ionization chamber (4 200 cc) allowing for the measurement of tritium activities in gases from 2 kBq/m<sup>3</sup> (54 nCi/m<sup>3</sup>) to 2 GBq/m<sup>3</sup> (54 mCi/m<sup>3</sup>).

Compact and high-performance, it combines under one housing a 4 200 cc ionization chamber inside its circulation chamber as well as an attached preamplifier.

Usually integrated in M ionix or C ionix - EXX, the DT D - EXP40 detector can be installed with a reference detector for a dynamic and automatic gamma compensation.

The detector is connected to a DT ionix 3™ touchscreen Human Machine Interface that can be installed several hundred meters away from the detector. It also benefits from the most advanced features such as graphical data plotting, data extraction via USB, Modbus communication, dry contact outputs...

### FEATURES

- ✓ **High performance**
  - Continuous measurement
  - Wide measurement range
  - Response time under 3 minutes
- ✓ **Easy to use**
  - Easy maintenance
  - User-friendly interface
  - Quick and easy commissioning
- ✓ **Reliable**
  - Precise and stable

## DT D - EXP40™ 4 200 CC TRITIUM DETECTOR

### GENERAL CHARACTERISTICS

- Dimensions: Ø 224 x 438 mm
- Weight: 13 kg
- Gas connection: DN 25KF coupling

### PERFORMANCES (For tritium in air, lab conditions)

Characteristics	EXP40
Measurement range of the electronics	2 kBq/m <sup>3</sup> to 2 TBq/m <sup>3</sup> 54 nCi/m <sup>3</sup> to 54 Ci/m <sup>3</sup>
Limit of detection of the device (2σ)	12.5 kBq/m <sup>3</sup> 0.43 μCi/m <sup>3</sup>
Maximum deviation	5% of measurement ± 12.5 kBq/m <sup>3</sup> ± 0.43 μCi/m <sup>3</sup>
Variation max	12.5 kBq/m <sup>3</sup> /year (0.43 μCi/m <sup>3</sup> /year)
Noise (2σ)	12.5 kBq/m <sup>3</sup> (0.43 μCi/m <sup>3</sup> )
Response time	< 3 min for 90% of step
Nominal flow rate	15-20 L/min

### IONIZATION CHAMBER

- Material: 304L microblasted s. steel - brass
- Volume: 4 200 cc
- Circulation chamber: 12 000 cc

### OPERATING CONDITIONS

- Humidity: < 95% relative, no condensation
- Operating temperature: +0 °C to +40 °C (+32 °F to +104 °F)
- Influence of humidity: ± 1% of the measurement from 10 to 90% relative humidity
- Influence of temperature: 0.3%/°C for a variation of ambient temperature < 3°C/hour
- Influence of atmospheric pressure: 0.1%/mbar, hence ± 5% of the measurement from 930 to 1030 mbar

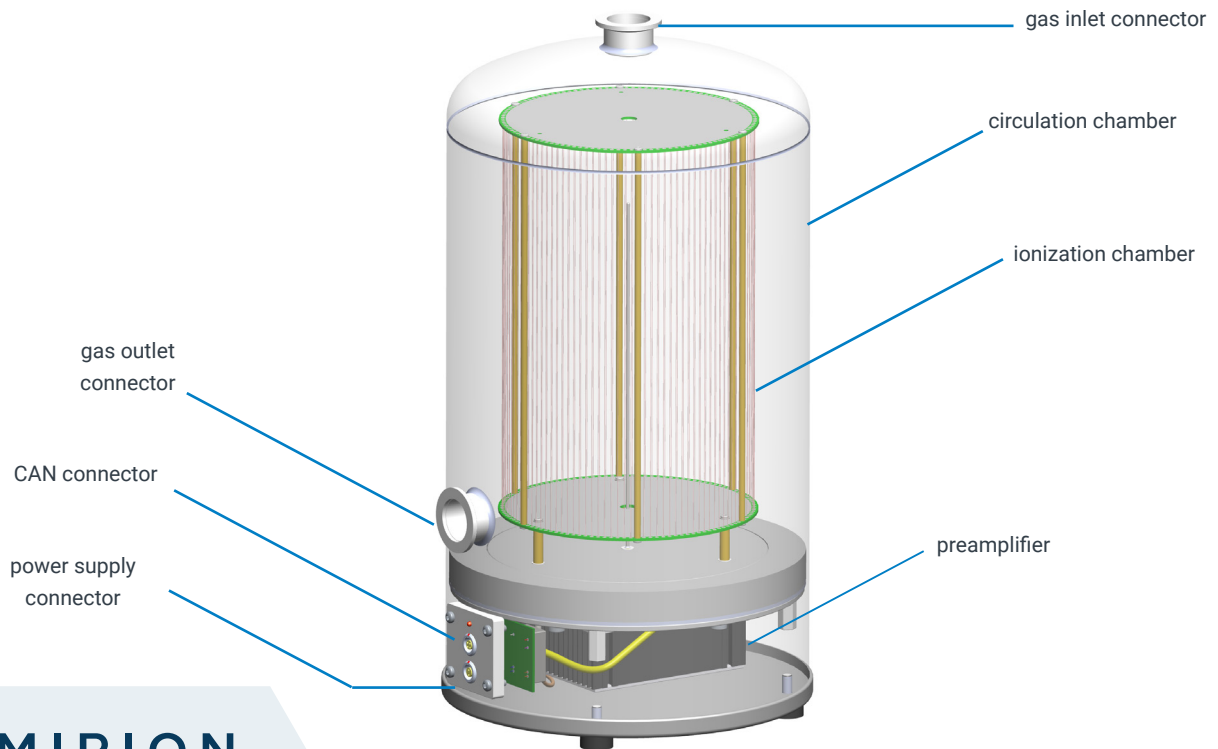

**MIRION**  
TECHNOLOGIES

Copyright © 2025 Mirion Technologies, Inc. or its affiliates. All rights reserved. Mirion, the Mirion logo, and other trade names of Mirion products listed here in are registered trademarks or trademarks of Mirion Technologies, Inc. or its affiliates in the United States and other countries. Third party trademarks mentioned are the property of their respective owners.



PREMIUM ANALYSE™

# DT D - XPR80™

## Inline 8L Tritium Detector



8 L ionization chamber for use in the field or for radioprotection, environmental monitoring and process surveillance.

### DESCRIPTION

The DT D - XPR80 detector is a high-volume ionization chamber (8 000 cc) allowing for measurement of tritium activity in gases from 2 kBq/m<sup>3</sup> (54 nCi/m<sup>3</sup>) to 2 GBq/m<sup>3</sup> (54 mCi/m<sup>3</sup>).

The XPR80 detector is unique thanks to its compactness. It includes an interchangeable particles filter with a gas heating system preventing any condensation. It can be connected to a flange circulator allowing to generate a gas stream in the detector.

The XPR80 ionization chamber also has the advantage of having the preamplifier on the outside, allowing for easy potential maintenance operations.

The detector is connected to a DT ionix 3™ touchscreen Human Machine Interface that can be installed several hundred meters away from the detector. Thanks to that, it benefits from the most advanced features such as graphical data plotting, data extraction via USB, Modbus communication, dry contact outputs...

### FEATURES

#### ✓ High performance

- Precise and stable
- Continuous measurement
- Response time below 3 minutes
- Tritium detection from 10 kBq/m<sup>3</sup> (0.135 µCi/m<sup>3</sup>)

#### ✓ Simple

- Easy maintenance
- Accessible electronics
- Direct in-line measurement
- Quick and easy commissioning

#### ✓ Customizable

- Several configurations available
- Several filtration systems available



## DT D - XPR80™ INLINE 8L TRITIUM DETECTOR

### GENERAL CHARACTERISTICS

- Dimensions: Ø 215 x 626 mm
- Weight: 21 kg (with filter, no circulator)

### PERFORMANCES (For tritium in air, lab conditions)

Characteristics	XPR80 (connected to a DT P - LN - 1A7 preamp)
Measurement range of the electronics	2 kBq/m <sup>3</sup> to 2 TBq/m <sup>3</sup> 54 nCi/m <sup>3</sup> to 54 Ci/m <sup>3</sup>
Limit of detection of the device (2σ)	10 kBq/m <sup>3</sup> 0.27 μCi/m <sup>3</sup>
Maximum deviation	5% of measurement ± 10 kBq/m <sup>3</sup> ± 0.27 μCi/m <sup>3</sup>
Variation max	10 kBq/m <sup>3</sup> /year (0.27 μCi/m <sup>3</sup> /year)
Noise (2σ)	10 kBq/m <sup>3</sup> (0.27 μCi/m <sup>3</sup> )
Response time	< 3 min for 90% of step
Nominal flow rate	70 L/min

### IONIZATION CHAMBER

- Material: 304L stainless steel electropolished.
- Ionization volume: 8000 cc
- Circulation volume: 12 000 cc
- Design pressure: 10 bars abs

### OPERATING CONDITIONS

- Humidity: < 95% relative, no condensation
- Operating temperature: +0 °C to +40 °C (+32 °F to +104 °F)
- Influence of humidity: ± 1% of the measurement from 10 to 90% relative humidity
- Influence of temperature: 0.3%/°C for a variation of ambient temperature < 3°C/hour
- Influence of atmospheric pressure: 0.1%/mbar, hence ± 5% of the measurement from 930 to 1030 mbar

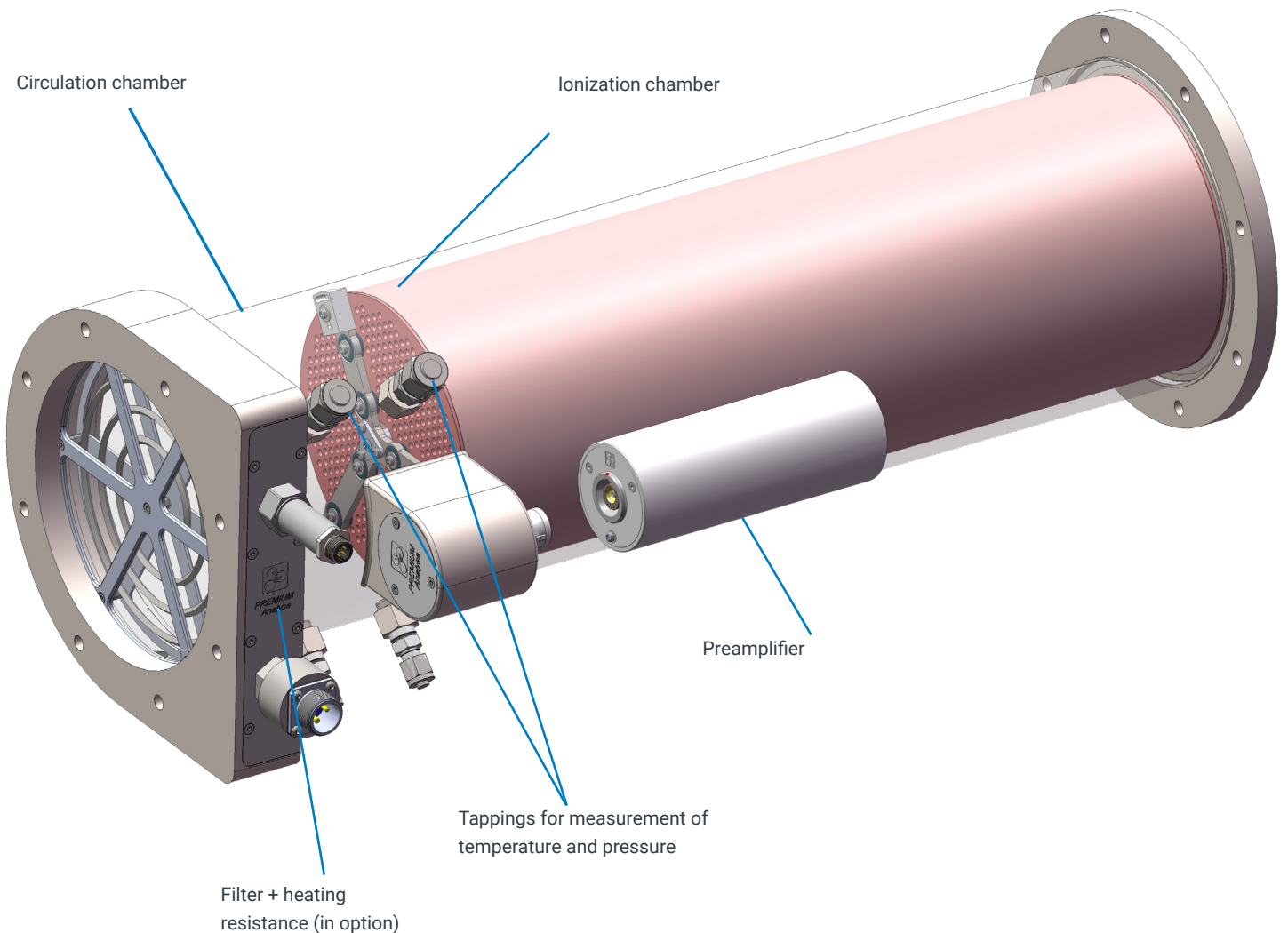

**DT D - XPR80™ INLINE 8L TRITIUM DETECTOR**

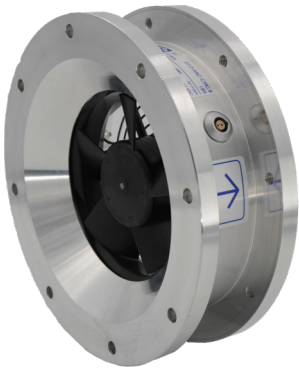

**DT D - XAC - CIRCB**

Flanged circulator, to be mounted after the ionization chamber  
 Nominal flow 70 L/min  
 Allows the creation of a gas glow

**XPR ACC TFL CF4**

Filter unit with heating resistance  
 400W power  
 Prevents the condensation of gas



**GAS CALIBRATION**

Thanks to our internal laboratory, we are able to calibrate all of our detectors thanks to standard gas samples generated.

Tests are made according to NF EN 60761-1 and -5 standards.

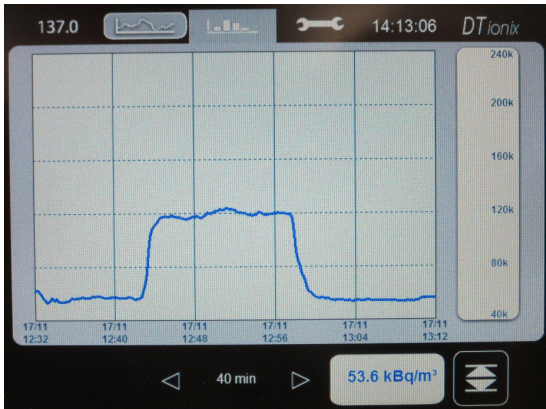

Response to a 120 kBq/m³ injection

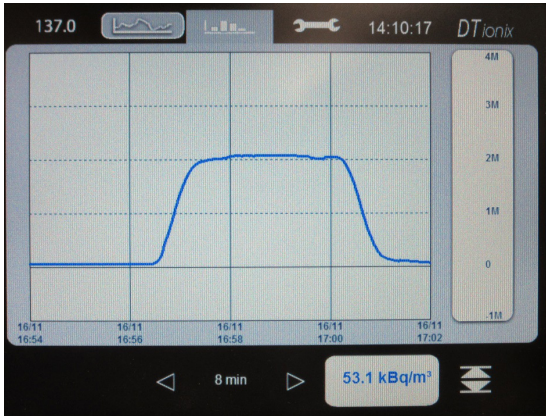

Response to a 2 MBq/m³ injection

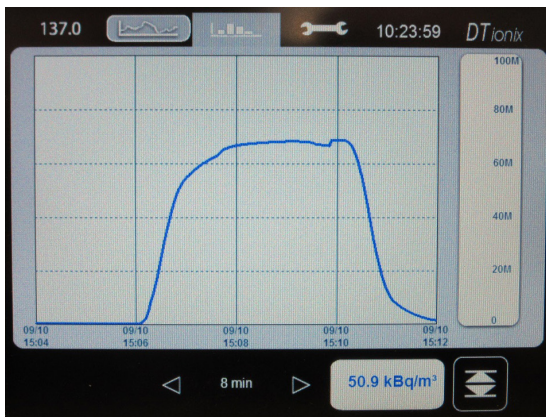

Response to a 70 MBq/m³ injection

**PREMIUM Analyse**

*always one idea ahead*

**β** activity measurement  
<sup>85</sup>Kr <sup>133</sup>Xe  
<sup>222</sup>Rn <sup>14</sup>C  
 Tritium

*Tritium calibration report*  
**DT D – XPR 80**

**#XXX**



Test Laboratory LAB IONIX  
 Z AC Euromoselle Sud  
 9, rue de la Fontaine Chaudron  
 57140 NORROY LE VENEUR  
 tél. + 33 (0)3 87 51 31 75  
 fax + 33 (0)3 87 51 31 74  
 www . premium - analyse . fr

Miton Technologies (Premium Analyse) SAS - SAS au capital de 100 000€ - RCS METZ B:414 979 336 - SIRET 414 979 336 00024 - APE 2651B - TVA FR 56 414 979 336

Calibration report

## DT D - XPR80™ INLINE 8L TRITIUM DETECTOR

### REFERENCES

Inline activity detector 4 tappings, aluminum filter	DT D XPR - 80 - FA0
Inline activity detector 4 tappings, heating filter, PT100 3 cables probe	DT D XPR - 80 - FC0
Inline activity detector 4 tappings, heating filter, PT100 4-20mA probe	DT D XPR - 80 - FCA
Inline activity detector 4 tappings with SWA 6-10mm connector, heating filter, PT100 4-20mA probe	DT D XPR - 80 - 018
Inline activity detector Heating filter, PT100 4-20mA probe	DT D XPR - 80 - 137

### ACCESSORIES

Flanged circulator 60 L/min	DT D - XAC - CIRCB
Ambiance circulator 60 L/min	DT D - XAC - CIRCA
Heating regulation box	DT D - XCE - 10100 - 000 - 018
Conical reducer	XPR ACC RCN
Installation system	XPR ACC FIX
Aluminum filter	XPR ACC TFA
Heating filter with PT100 probe	XPR ACC TFL CFG
Heating filter with 4-20mA probe	XPR ACC TFL CF4
Vertical mounting accessory for preamp	XPR ACC PLN FIX

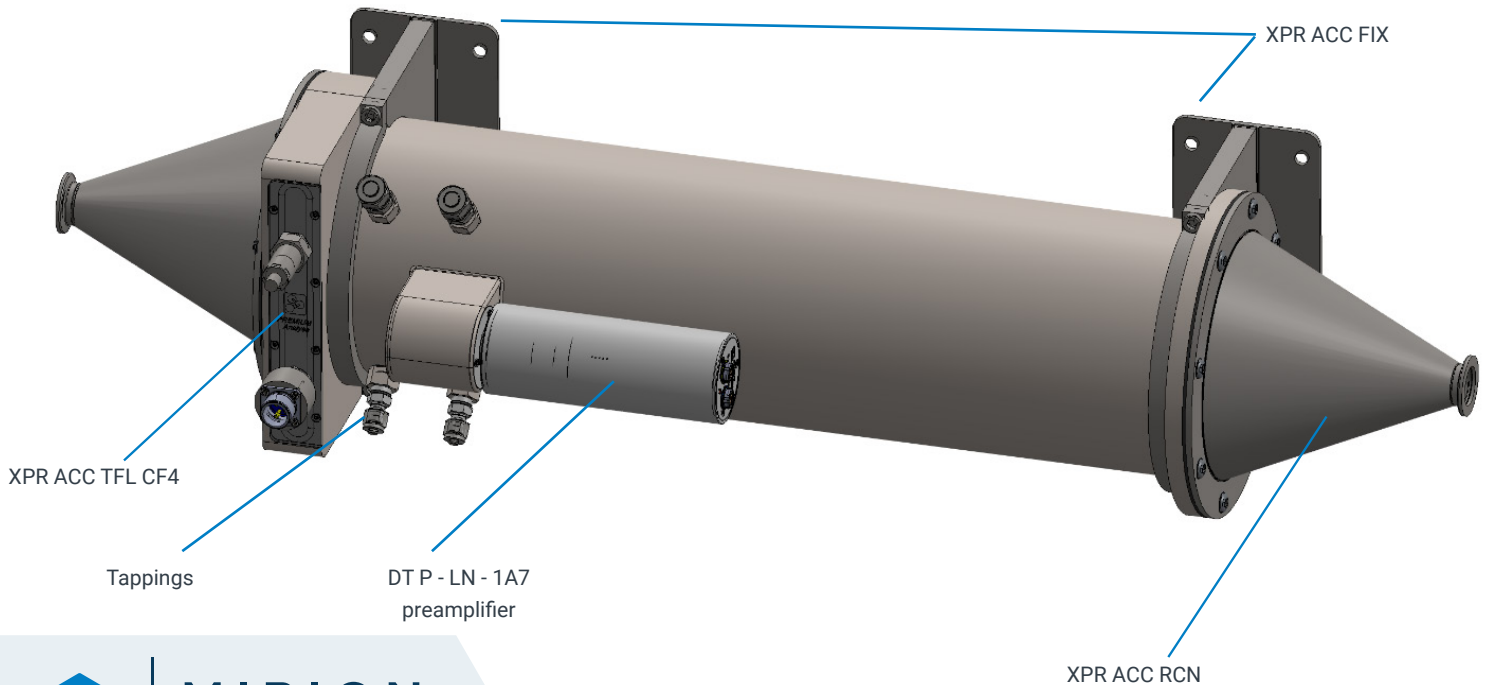

**MIRION**  
TECHNOLOGIES

Copyright © 2025 Mirion Technologies, Inc. or its affiliates. All rights reserved. Mirion, the Mirion logo, and other trade names of Mirion products listed herein are registered trademarks or trademarks of Mirion Technologies, Inc. or its affiliates in the United States and other countries. Third party trademarks mentioned are the property of their respective owners.



NEUTRON FLUX MONITORING SYSTEMS

# proTK™ RR

## Reactor Safety and Control for Research Reactors

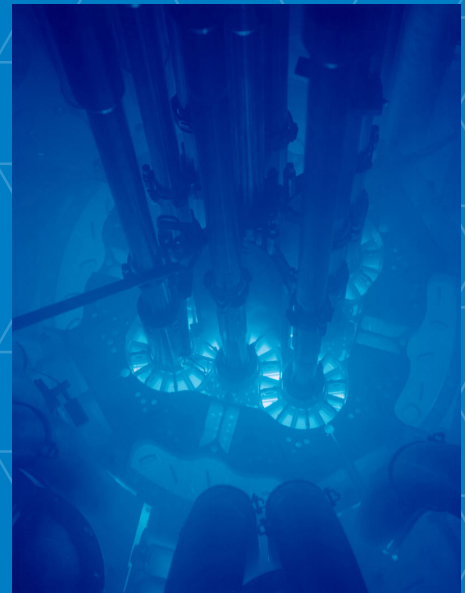

Neutron flux monitoring in research and test reactors for all modes of operation.

### DESCRIPTION

With the proTK™ product line Mirion is offering state-of-the-art equipment for neutron flux monitoring that is versatile and high performing. Due to its modularity, it can be integrated into nuclear facilities of any size and complexity, including research reactors.

proTK™ neutron flux monitoring channels are providing fast and reliable information on neutron flux levels and trends, therefore allowing the operator to constantly monitor the reactor power and stay ahead of (planned or unexpected) events.

proTK™ RR is Mirion's program for providing reliable and versatile equipment and services to operators of research and test reactors, e.g. the common TRIGA®, to support safe operation while maintaining and improving performance.

### FEATURES

- ✓ Comprehensive neutron flux monitoring solutions for research reactors
- ✓ Modular design, highly customizable
- ✓ Reliable and low maintenance, integrated test functions, continuous self-monitoring
- ✓ Large variety of detectors: fission chambers, B-10 proportional counters and ionization chambers
- ✓ Water-tight detector housing for in-pool measurement
- ✓ Total coverage of neutron flux levels from 0.1 to 1E+11 nv
- ✓ 10+ decades of neutron flux with one WR FC and signal processing unit
- ✓ Isolated safety signals for RPS
- ✓ Optional secured serial interface
- ✓ Qualified for Category A functions (Class 1 system) acc. IEC 61226
- ✓ Life-time support and services, incl. engineering and licensing support

# proTK™ REACTOR SAFETY AND CONTROL FOR RESEARCH REACTORS

## PROTK™ NEUTRON FLUX MONITORING CHANNELS FOR RR

For measuring the neutron flux and the corresponding reactor power during reactor start-up and power operation, various types of proTK™ neutron flux monitoring channels are available. The table below and the schematic drawing show the coverage by type of proTK™ monitor.

	proTK™ MONITORS	FOR REACTOR POWER OPERATION		
	FOR REACTOR START-UP			
Description	Source Range Monitor SRM 510™	Intermediate Range Monitor IRM 510™	Wide Range Monitor WRM 510™	Power Range Monitor PRM 510™
Signal Processing Unit/Pre-amplifier	DAK 260-i/NV 320	DAK 260-g/NV 102	DWK 260/NV 230	DGK 260/-
Detector Type (Example)	B-10 proportional counter (PN 25, PN 50), Fission counter (WL-6376A), BF3 counter (NY-10937)	γ-compensated neutron ionization chamber (KNK 50 ACH)	WR fission chamber (NY-11016, WL-6376A)	(1 or 2) uncompensated neutron ionization chamber (KNU 50 ACH)
Typical Neutron Flux Range (nv)	0.1 ... 2 10 <sup>5</sup>	10 <sup>2</sup> ... 10 <sup>10</sup>	1 ... 10 <sup>10</sup>	10 <sup>2</sup> ... 10 <sup>10</sup>
Typical Channel Outputs and Scaling	0.1 ... 10 <sup>5</sup> nv 10 <sup>-8</sup> ... 10 <sup>-2</sup> %FP -1.25 ... 0 ... +12.5 %/s	10 <sup>2</sup> ... 10 <sup>10</sup> nv 10 <sup>-6</sup> ... 100 %FP -1.25 ... 0 ... +12.5 %/s	1 ... 10 <sup>10</sup> nv 10 <sup>-8</sup> ... 100 %FP -1.25 ... 0 ... +12.5 %/s 0 ... 150 %FP	0 ... 125 %FP -10 ... 0 ... +10 %FP/s -30 ... +30 %FP (axial deviation)

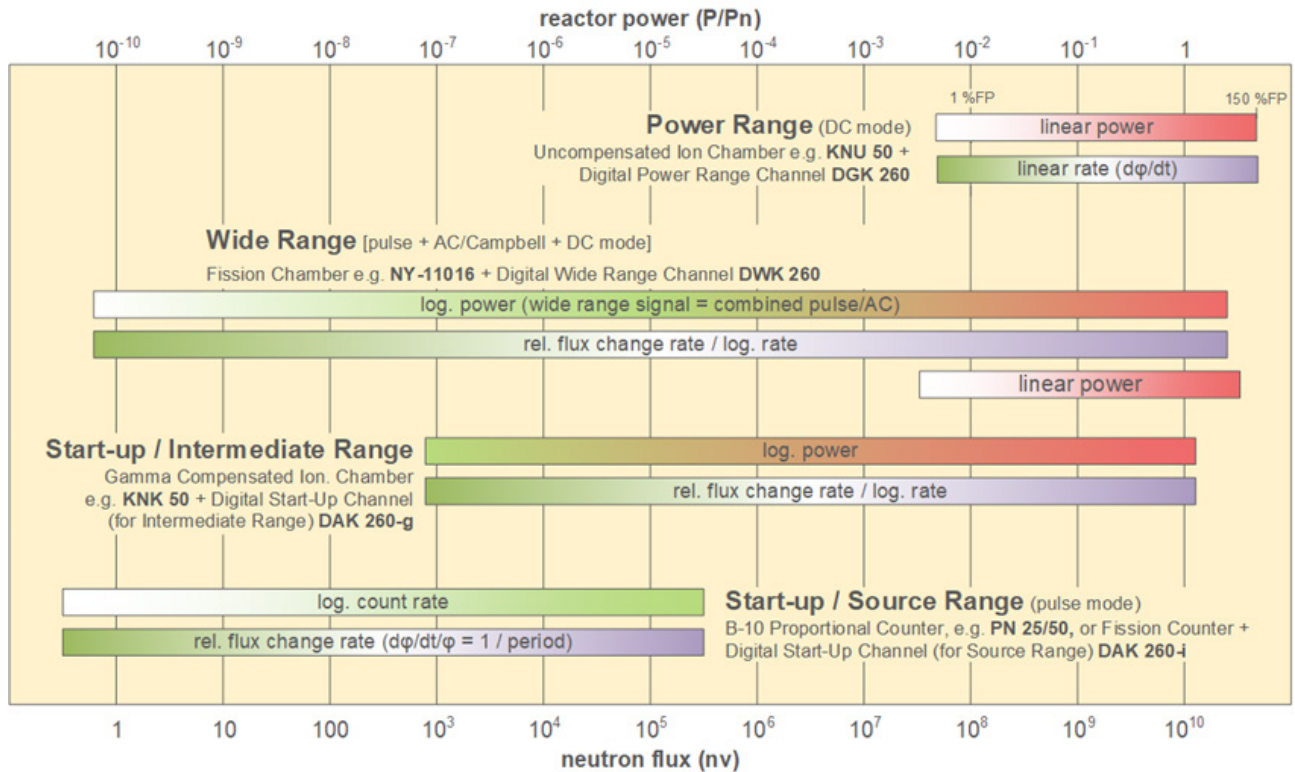

## proTK™ REACTOR SAFETY AND CONTROL FOR RESEARCH REACTORS

### PROTK™ DETECTOR HOUSING FOR RR

In addition to neutron detectors and suitable signal processing units, Mirion is also offering the mechanical components for mounting and positioning the detectors in suitable locations around the reactor core.

Here an example of a standard housing for mounting detector inside the pool of a research reactor.

The watertight housing shown here is fabricated from aluminum alloy 6061 and delivered in two (2) sections. These sections are joined using a gasket and stainless-steel fasteners.

The upper rigid conduit section features an offset to mitigate streaming. A detector is installed into the lower housing section at the Mirion factory and is not field replaceable. Typically, this watertight housing is used to encapsulate an Ion Chamber, Fission Chamber or Proportional Counter (with BF<sub>3</sub> gas or B-10 coated). Dimensions of the housing depending on the detector being housed.

The upper section of rigid conduit is typically secured to the reactor bridge or similar structure using conduit clamps. An optional sealing gland can be added to top of rigid conduit.

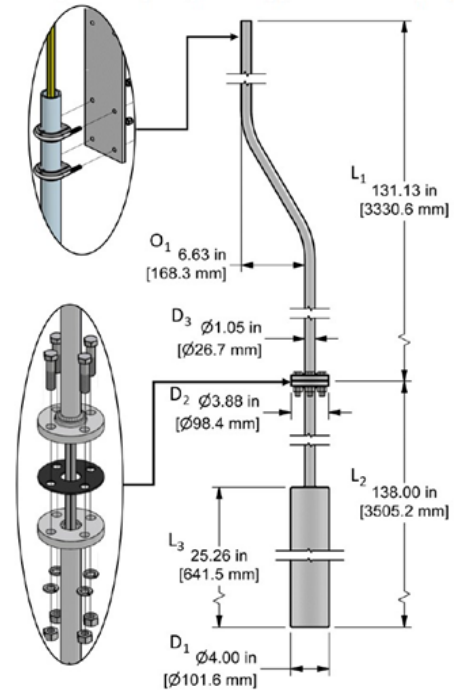

### PROTK™ SUPPORT AND SERVICES FOR RESEARCH REACTORS

Along with standard or custom state-of-the-art equipment Mirion is supporting research reactors operators throughout the facility's lifetime with services including:

- Preliminary feasibility studies, incl. support for creating a system requirement specification for a modernization project
- Customized design, development and engineering incl. equipment qualification acc. to nuclear standards, especially for safety systems, and support throughout the licensing process
- Installation, commissioning, site acceptance testing and product training for individuals and groups
- Repair and maintenance

#### Acronyms:

RR = Research Reactor (incl. test and training reactors and other nuclear reactors whose main purpose is not the generation of electrical power)  
FC = Fission Chamber; IC = Ionization Chamber; PC = Proportional Counter; SR, IR, PR, WR = Source, Intermediate, Power, Wide Range; I&C = Instrumentation & Control

#### Units:

1 nv = 1 neutron / (cm<sup>2</sup> s)  
rel. flux change rate =  $(1/\phi) d\phi / dt$   
= 1 / reactor period

Credits (title picture): US NRC (<http://www.nrc.gov>)



Copyright © 2024 Mirion Technologies, Inc. or its affiliates. All rights reserved. Mirion, the Mirion logo, and other trade names of Mirion products listed herein are registered trademarks or trademarks of Mirion Technologies, Inc. or its affiliates in the United States and other countries. Third party trademarks mentioned are the property of their respective owners.



PROTK™ NEUTRON FLUX MONITORS

# SRM 510™

## Source Range Monitor

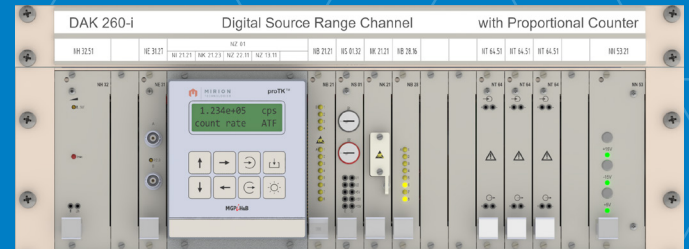

Neutron flux monitor for reactor start-up in the source range.

### DESCRIPTION

At the heart of the SRM 510 source range monitor resides the DAK 260-i digital start-up signal processing unit that belongs to the Mirion proTK™/260 series of signal processing units for safety critical applications.

The DAK 260-i channel can be used with any type of neutron detector in the pulse mode and a matching pulse-preamplifier.

Hardware and software of the SRM 510 monitor are designed and qualified for use at the level of the reactor protection system.

With the SRM 510 monitor, Mirion provides the complete neutron monitoring system for the source range during reactor start-up from neutron detector to the safety signals for reactor protection and control.

### FEATURES

- ✓ Modular design, highly customizable
- ✓ Operated with a B-10, BF<sub>3</sub>, He-3 proportional counter or a fission counter
- ✓ Provides the count rate, calibrated neutron flux (nv) or reactor power (%FP, W, ...)
- ✓ Calculation of flux change rate (reciprocal of the reactor period)
- ✓ Signal filtering with adaptive filter parameters
- ✓ Generation of analog output signals with lin. or log. scaling
- ✓ Generation of binary alarm, trip and status indication signals
- ✓ Integrated test signal generators and simulation capabilities
- ✓ Secured serial interface
- ✓ Custom detector assemblies and mounting options, field cables and connectors available on request
- ✓ Qualified for Category A functions (Class 1 systems) acc. IEC 61226

# SRM 510™ SOURCE RANGE MONITOR

DETECTORS						
Type	Product Code	Sensitivity (cps/nv)	Nominal Op. Voltage (VDC)	Neutron Flux Range (nv)	Dimensions (mm) $\phi$ , L (total)	Integral Cable, Connectors
<b>B-10 Proportional Counters</b>	PN 25	4.5	800	1.0e-1 ... 2.0e+5	25, 417	1 x HN
	PN 50-2/4/6	5 / 10 / 15	800	1.0e-1 ... $\leq$ 3e+5	50, 379 / 559 / 739	1 x MI-cable + HN
<b>BF<sub>3</sub> Counters</b>	NY-10937	4.5	2,050	2.2e-1 ... 2.2e+4	25.4, 330	1 x HN
	WL-24425	25	3,500	1.0e-1 ... 7.0e+4	25.4, 595	1 x Type 237 (coax.)
<b>Fission (U-235) Counters</b>	WL-23110	0.18	300	6.0e-0 ... 6.0e+5	25.4, 305	1 x HN
	WL-6376A	0.7	300	1.4e-0 ... 1.4e+5	50.8, 292	1 x HN

The detectors are designed to withstands max. temperatures from 107 °C/225 °F (BF3 counters) to 357 °C/676 °F (Fission Counter WL-23110). For the full range of available detectors, for specific applications and for receiving further technical data, please contact Mirion.

DIGITAL SIGNAL PROCESSING
Multi-processor system
Protected program memory
Non-volatile parameter memory
RS-232 and/or RS-485 serial interface for measurement data, status information and parameter settings
Internal LC-display: 2 x 16 characters

OUTPUT SIGNALS	
<b>Log. count rate/neutron flux</b>	0.5 ... 5e+5 cps 0.1 ... 1e+5 nv
<b>Linear count rate (DAK 260-i)</b>	0 ... 5e+5 cps
<b>Relative flux change rate (log rate = 1/reactor period)</b>	-3.33 ... 0 ... +33.3 %/s (equiv. period -30 ... $\infty$ ... +3 s)
<b>Analog outputs</b>	0/4 ... 20 mA/600 $\Omega$ , isolated
<b>Binary outputs (isolated relay changeovers)</b>	60 V/0.5 A or 125 V/1 A

The shown scaling of the output signals are examples and can be configured according to the application requirements.

ACCESSORIES	
<b>Cabinet, incl. EMI/EMC and seismic testing</b>	I&C cabinet or wall mounted housing (e.g. IEC 61000-6 2/4, IEEE 344)
<b>Field cables (&gt; 100 m)</b>	Organic, low noise coaxial or triaxial field cables Halogen free, flame retardant (e.g. IEE 383, IEC 60754-1, IEC 60332-1-2)

PRE-AMPLIFIERS	
<b>Pulse pre-amplifier NV 320</b>	Characteristic I/O impedance matched to cables (e.g. 50 or 75 $\Omega$ )
<b>Integrated test signal generators (pulses or DC)</b>	Activation via HMI or through serial interface.

ENVIRONMENTAL, ELECTRICAL, MECHANICAL CHARACTERISTICS (SIGNAL PROCESSING UNITS)	
<b>AC/DC power supply 230 VAC or 115 VAC 18 ... 33 VDC</b>	+10%/-15%, approx. 30 VA
<b>High voltage supply HV module in DAK 260-i</b>	Adjustable within max. range: 0 ... 0.5/1/2/4 kV
<b>Operating temperature open rack recommended long-term op.</b>	0 ... 70 °C (32 ... 158 °F) 10 ... 40 °C (50 ... 104 °F)
<b>Mechanical vibrations</b>	max. 5 g, 5 ... 100 Hz (or acc. custom requirements)
<b>Dimensions (mm/inch) Rack (W×H×D) Plug-in modules</b>	19" system acc. IEC 60297 483 × 133 × 280 / 19 x 5.2 x 11 100 × 160 / 3.9 x 6.3

QUALIFICATION / DESIGN STANDARDS (SELECTION)	
<b>Design Software Qualification</b>	IEC 61513 / IEEE 603 IEC 60880 / IEEE 7.4.3.2 IEC/IEEE 60780-323 IEC/IEEE 60980-344

RELATED PRODUCTS	
<b>DAK 260</b>	Digital signal processing unit for reactor start-up
<b>IRM/PRM/WRM 510</b>	Intermediate/power/wide range monitor



Copyright © 2024 Mirion Technologies, Inc. or its affiliates. All rights reserved. Mirion, the Mirion logo, and other trade names of Mirion products listed herein are registered trademarks or trademarks of Mirion Technologies, Inc. or its affiliates in the United States and other countries. Third party trademarks mentioned are the property of their respective owners.





PROTK™ NEUTRON FLUX MONITORS

# IRM 510™

## Intermediate Range Monitor

Neutron flux monitor for reactor start-up in the intermediate range.

### DESCRIPTION

At the heart of the IRM 510 intermediate range monitor resides the DAK 260-g digital startup signal processing unit that belongs to the Mirion proTK™/260 series of signal processing units for safety critical applications.

The DAK 260-g channel can be used with any type of neutron ionization chamber and a matching current-to-frequency converter to cover up to 10 decades of neutron flux during reactor start-up.

Hardware and software of the IRM 510 monitor are designed and qualified for use at the level of the reactor protection system.

With the IRM 510 monitor, Mirion provides the complete neutron monitoring system for the intermediate range during reactor start-up from neutron detector to the safety signals for reactor protection and control.

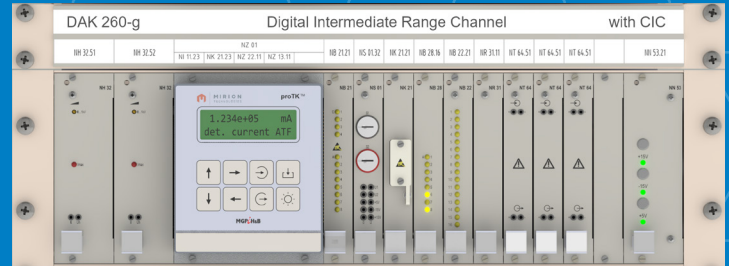
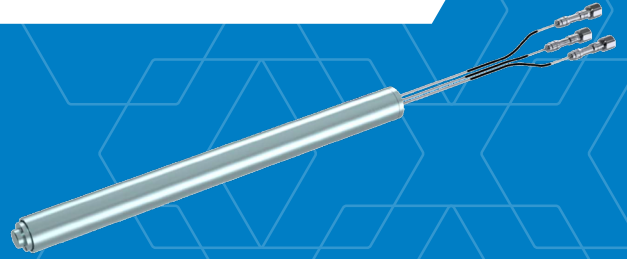

### FEATURES

- ✓ Modular design, highly customizable
- ✓ Operated with a B-10 lined, compensated or uncompensated neutron ionization chamber (CIC/UIC)
- ✓ Provides the calibrated neutron flux (nv) or reactor power (%FP, W, ...)
- ✓ Calculation of flux change rate (reciprocal of the reactor period)
- ✓ Signal filtering with adaptive filter parameters
- ✓ Generation of analog output signals with lin. or log. scaling
- ✓ Generation of binary alarm, trip and status indication signals
- ✓ Integrated test signal generators and simulation capabilities
- ✓ Secured serial interface
- ✓ Custom detector assemblies and mounting options, field cables and connectors available on request
- ✓ Qualified for Category A functions (Class 1 systems) acc. IEC 61226

# IRM 510™ INTERMEDIATE RANGE MONITOR

DETECTORS						
Type	Product Code	Sensitivity (A/nv) x 10 <sup>-14</sup>	Nominal Op. Voltage (VDC)	Neutron Flux Range (nv)	Dimensions (mm) ϕ, L (total)	Integral Cable, Connectors
Compensated B-10 neutron ionization chamber (CIC)	KNK 50-1 ACH	0.7	800, -500 (comp. voltage)	1.0e+2 ... 1.0e+10	50, 255 ... 50, 705	3 x (MI-cable + HN)
	...	...				
	KNK 50-6 ACH	4.4				
Uncompensated B-10 neutron ionization chamber (UIC)	KNU 50-1 ACH	0.7	800	1.0e+2 ... 1.0e+10	50, 255 ... 50, 705	2 x (MI-cable + HN)
	...	...				
	KNU 50-6 ACH	4.4				

The KNK/KNU 50™ ACH are designed to withstand accident/LOCA conditions (max. 200 °C/390 °F, 800 kPa/116 psi, 100% saturated steam). For the full range of available detectors, for specific applications and for receiving further technical data, please contact Mirion.

DIGITAL SIGNAL PROCESSING
Multi-processor system
Protected program memory
Non-volatile parameter memory
RS-232 and/or RS-485 serial interface for measurement data, status information and parameter settings
Internal LC-display: 2 x 16 characters

OUTPUT SIGNALS	
Log. neutron flux or reactor power	1E+2 ... 1e+10 nv 1.5E-6 ... 1.5e+2 %FP
Linear multirange power signal with range indication	Full scale: 125/40/12.5/ ... %FP (16 ranges/half-decades)
Relative flux change rate (log rate = 1/reactor period)	-3.33 ... 0 ... +33.3 %/s (equiv. period -30 ... ∞ ... +3 s)
Analog outputs	0/4 ... 20 mA/600 Ω, isolated
Binary outputs (isolated relay changeovers)	60 V/0.5 A or 125 V/1 A

The shown scaling of the output signals are examples and can be configured according to the application requirements.

ACCESSORIES	
Cabinet, incl. EMI/EMC and seismic testing	I&C cabinet or wall mounted housing (e.g. IEC 61000-6 2/4, IEEE 344)
Field cables (> 100 m)	Organic, low noise coaxial or triaxial field cables Halogen free, flame retardant (e.g. IEE 383, IEC 60754-1, IEC 60332-1-2)

PRE-AMPLIFIERS	
I/F converter (for ion. chambers) NV 102 NV 103	10 decades of meas. range: 1e-13 A ... 1e-3 A 1e-14 A ... 1e-4 A
Integrated test signal generators (pulses, AC and DC)	Activation via HMI or through serial interface.

ENVIRONMENTAL, ELECTRICAL, MECHANICAL CHARACTERISTICS (SIGNAL PROCESSING UNITS)	
AC/DC power supply 230 VAC or 115 VAC 18 ... 33 VDC	+10% / -15%, approx. 30 VA
High voltage supply HV module(s) in DAK 260-g	Adjustable within max. range: 0 ... 0.5/1/2/4 kV
Operating temperature open rack recommended long-term op.	0 ... 70 °C (32 ... 158 °F) 10 ... 40 °C (50 ... 104 °F)
Mechanical vibrations	max. 5 g, 5 ... 100 Hz (or acc. custom requirements)
Dimensions (mm/inch) Rack (W×H×D) Plug-in modules	19" system acc. IEC 60297 483 × 133 × 280 / 19 x 5.2 x 11 100 × 160 / 3.9 x 6.3

QUALIFICATION / DESIGN STANDARDS (SELECTION)	
Design Software Qualification	IEC 61513 / IEEE 603 IEC 60880 / IEEE 7.4.3.2 IEC/IEEE 60780-323 IEC/IEEE 60980-344

RELATED PRODUCTS	
DAK 260	Digital signal processing unit for reactor start-up
SRM/PRM/WRM 510	Source/power/wide range monitor



Copyright © 2024 Mirion Technologies, Inc. or its affiliates. All rights reserved. Mirion, the Mirion logo, and other trade names of Mirion products listed herein are registered trademarks or trademarks of Mirion Technologies, Inc. or its affiliates in the United States and other countries. Third party trademarks mentioned are the property of their respective owners.



PROTK™ NEUTRON FLUX MONITORS

# PRM 510™

## Power Range Monitor

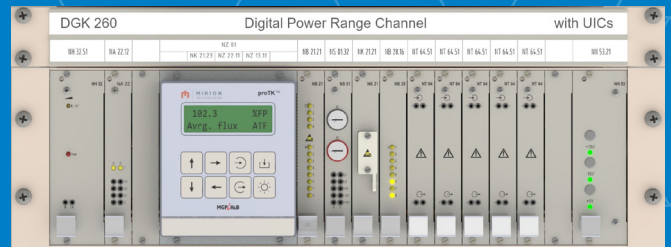
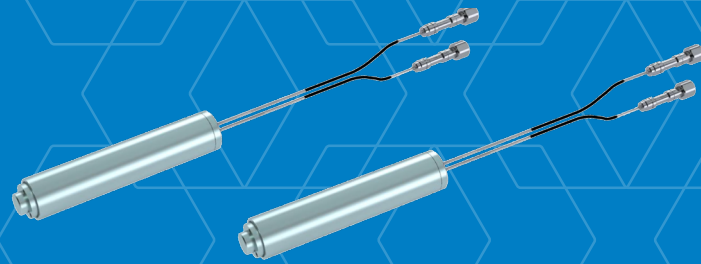

**Neutron flux monitor for reactor power operation.**

### DESCRIPTION

At the heart of the PRM 510 power range monitor resides the DGK 260™ digital power range signal processing unit that belongs to the Mirion proTK™/260 series of signal processing units for safety critical applications.

The DGK 260 channel can be used with up to two neutron ionization chambers and provides fast linear signals proportional to the reactor power.

Hardware and software of the PRM 510 monitor are designed and qualified for use at the level of the reactor protection system.

With the PRM 510 monitor, Mirion provides the complete neutron monitoring system for the power range from the neutron detectors to the safety signals for reactor protection and control.

### FEATURES

- ✓ Modular design, highly customizable
- ✓ Operated with up to two B-10 lined neutron ionization chambers
- ✓ Individual signal paths for the two ionization chambers
- ✓ Calculation of mean value, axial deviation and linear rate (of change)
- ✓ Independent calibration of output signals (nv, %FP)
- ✓ Optional signal filtering with fixed time constant
- ✓ Generation of analog signals with linear scaling, binary alarms, trip and status indication signals
- ✓ Fast response times (< 15 ms, without filtering)
- ✓ Integrated test signal generators and simulation capabilities
- ✓ Secured serial interface
- ✓ Qualified for Category A functions (Class 1 systems) acc. IEC 61226

# PRM 510™ POWER RANGE MONITOR

DETECTORS						
Type	Product Code	Sensitivity (A/nv) x 10 <sup>-14</sup>	Nominal Op. Voltage (VDC)	Neutron Flux Range (nv)	Dimensions (mm) ϕ, L (total)	Integral Cable, Connectors
Compensated B-10 neutron ionization chamber (CIC)	KNK 50-1 ACH	0.7	800, -500 (comp. voltage)	1.0e+2 ... 1.0e+10	50, 255 ... 50, 705	3 x (MI-cable + HN)
	...	...				
	KNK 50-6 ACH	4.4				
Uncompensated B-10 neutron ionization chamber (UIC)	KNU 50-1 ACH	0.7	800	1.0e+2 ... 1.0e+10	50, 255 ... 50, 705	2 x (MI-cable + HN)
	...	...				
	KNU 50-6 ACH	4.4				

The KNK/KNU 50™ ACH are designed to withstand accident/LOCA conditions (max. 200 °C/390 °F, 800 kPa/116 psi, 100% saturated steam). For the full range of available detectors, for specific applications and for receiving further technical data, please contact Mirion.

DIGITAL SIGNAL PROCESSING
Multi-processor system
Protected program memory
Non-volatile parameter memory
RS-232 and/or RS-485 serial interface for measurement data, status information and parameter settings
Internal LC-display: 2 x 16 characters

OUTPUT SIGNALS	
Top/bottom and average neutron flux or reactor power	Linear scaling: 0 ... 1e+10 nv 0 ... 125 %FP
Axial deviation (top/bottom)	-30 ... +30 %FP
Linear rate signal	-10 ... 0 ... +10 %FP/s
Analog outputs	0/4 ... 20 mA/600 Ω, isolated
Binary outputs (isolated relay changeovers)	60 V/0.5 A or 125 V/1 A

The shown scaling of the output signals are examples and can be configured according to the application requirements.

ACCESSORIES	
Cabinet, incl. EMI/EMC and seismic testing	I&C cabinet or wall mounted housing (e.g. IEC 61000-6 2/4, IEC 344)
Field cables (> 100 m)	Organic, low noise coaxial or triaxial field cables Halogen free, flame retardant (e.g. IEE 383, IEC 60754-1, IEC 60332-1-2)

ENVIRONMENTAL, ELECTRICAL, MECHANICAL CHARACTERISTICS (SIGNAL PROCESSING UNITS)	
AC/DC power supply 230 VAC or 115 VAC 18 ... 33 VDC	+10%/-15%, approx. 30 VA
High voltage supply HV module(s) in DGK 260-g	Adjustable within max. range: 0 ... 0.5/1/2/4 kV
Operating temperature open rack recommended long-term op.	0 ... 70 °C (32 ... 158 °F) 10 ... 40 °C (50 ... 104 °F)
Mechanical vibrations	max. 5 g, 5 ... 100 Hz (or acc. custom requirements)
Dimensions (mm/inch) Rack (W×H×D) Plug-in modules	19" system acc. IEC 60297 483 × 133 × 280 / 19 x 5.2 x 11 100 × 160 / 3.9 x 6.3

QUALIFICATION / DESIGN STANDARDS (SELECTION)	
Design Software Qualification	IEC 61513 / IEEE 603 IEC 60880 / IEEE 7.4.3.2 IEC/IEEE 60780-323 IEC/IEEE 60980-344

RELATED PRODUCTS	
DGK 260	Digital signal processing unit for power range
SRM/IRM/WRM 510	Source/intermediate/wide range monitor



Copyright © 2024 Mirion Technologies, Inc. or its affiliates. All rights reserved. Mirion, the Mirion logo, and other trade names of Mirion products listed herein are registered trademarks or trademarks of Mirion Technologies, Inc. or its affiliates in the United States and other countries. Third party trademarks mentioned are the property of their respective owners.

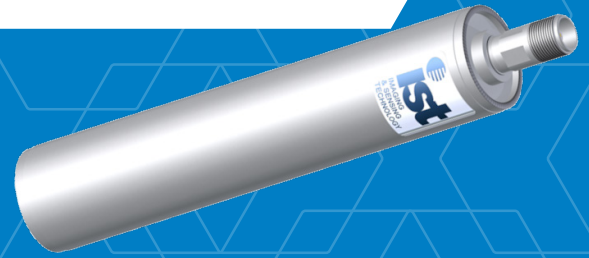

PROTK™ NEUTRON FLUX MONITORS

# WRM 510™

## Wide Range Monitor

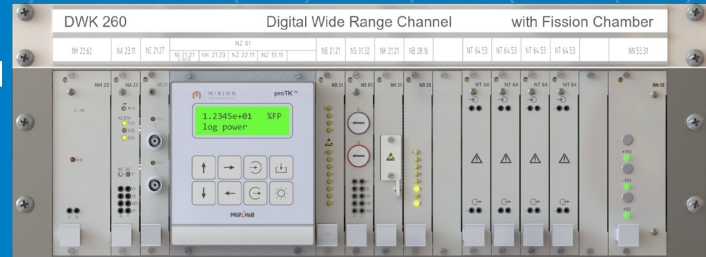

**Neutron flux monitor for reactor start-up and power operation.**

### DESCRIPTION

At the heart of the WRM 510 wide range monitor resides the DWK 260™ digital wide range signal processing unit that belongs to the Mirion proTK™/260 series of signal processing units for safety critical applications.

The DWK 260 channel can be used with any type of guarded or non-guarded wide range fission chamber to cover more than 10 decades of neutron flux during all modes of reactor operation.

Hardware and software of the WRM 510 monitor are designed and qualified for use at the level of the reactor protection system.

With the WRM 510 monitor, Mirion provides the complete neutron monitoring system for the wide range from neutron detector to the safety signals for reactor protection and control.

### FEATURES

- ✓ Modular design, highly customizable
- ✓ Operated with one wide range fission chamber (guarded or un-guarded)
- ✓ 10+ decades of neutron flux range coverage with one fission chamber
- ✓ Calibration of signal into units of neutron flux (nv) or reactor power (%FP, W, ...)
- ✓ Seamless calculation of the relative flux change rate (reciprocal of the reactor period) over the full neutron flux range
- ✓ Signal filtering with adaptive filter parameters
- ✓ Generation of analog output signals with linear or logarithmic scaling
- ✓ Generation of binary alarm, trip and status indication signals
- ✓ Integrated test-signal generators and simulation capabilities
- ✓ Secured serial interface
- ✓ Qualified for Category A functions (Class 1 system) acc. IEC 61226

# WRM 510™ WIDE RANGE MONITOR

DETECTORS						
Type	Product Code	Sensitivity (pulse, DC)	Nominal Op. Voltage (VDC)	Neutron Flux Range (nv)	Dimensions (mm) $\phi$ , L (total)	Integral Cable, Connectors
Guarded Wide Range Fission Chamber	NY-11016	0.7 cps/nv 2e-13 A/nv	800	2.0e+0 ... 2.0e+10	76.2, 580	2 x (MI-cable + HN)
Wide Range Fission Chamber (unguarded)	WL-6376A	0.7 cps/nv 1.4e-13 A/nv	800	1.4e+0 ... 1.4e+10	50.8, 292	1 x HN

The wide range fission chambers are designed for min. operation of 150 °C/300 °F.  
For the full range of available detectors, for specific applications and for receiving further technical data, please contact Mirion.

DIGITAL SIGNAL PROCESSING
Multi-processor system
Protected program memory
Non-volatile parameter memory
RS-232 and/or RS-485 serial interface for measurement data, status information and parameter settings
Internal LC-display: 2 x 16 characters

OUTPUT SIGNALS	
Pulse count rate (logarithmic)	0.5 ... 5e+5 cps
Campbell (AC/MSV) signal	> 7 decades
Wide-range signal (logarithmic power)	1 ... 1e+10 nv, 1.5e-8 ... 150 %FP
Relative flux change rate (log rate = 1/reactor period)	-3.33 ... 0 ... +33.3 %/s (equiv. period -30 ... $\infty$ ... +3 s)
Linear DC signal (linear power)	0 to 150 %FP
Linear rate signal	-10 ... 0 ... +10 %FP/s
Analog outputs	0/4 ... 20 mA/600 $\Omega$ , isolated
Binary outputs (isolated relay change overs)	60 V/0.5 A or 125 V/1 A

The shown scaling of the output signals are examples and can be configured according to the application requirements.

ACCESSORIES	
Cabinet, incl. EMI/EMC and seismic testing	I&C cabinet or wall mounted housing (e.g. IEC 61000-6 2/4, IEEE 344)
Field cables (> 100 m)	Organic, low noise coaxial or triaxial field cables Halogen free, flame retardant (e.g. IEE 383, IEC 60754-1, IEC 60332-1-2)

PRE-AMPLIFIERS	
Type NV 230 series	Compatible to all common wide range fission chambers
Processing	Pulses, AC (Campbell) and DC signals
Integrated test signal generators (pulses, AC and DC)	Activation via HMI or through serial interface

ENVIRONMENTAL, ELECTRICAL, MECHANICAL CHARACTERISTICS (SIGNAL PROCESSING UNITS)	
AC/DC power supply 230 VAC or 115 VAC 18 ... 33 VDC	+10%/-15%, approx. 30 VA
High voltage supply HV module in DWK 260	Adjustable within max. range: 0 ... 0.5/1/2/4 kV
Operating temperature open rack recommended long-term op.	0 ... 70 °C (32 ... 158 °F) 10 ... 40 °C (50 ... 104 °F)
Mechanical vibrations	max. 5 g, 5 ... 100 Hz (or acc. custom requirements)
Dimensions (mm/inch) Rack (W×H×D) Plug-in modules	19" system acc. IEC 60297 483 × 133 × 280 / 19 x 5.2 x 11 100 × 160 / 3.9 x 6.3

QUALIFICATION / DESIGN STANDARDS (SELECTION)	
Design Software Qualification	IEC 61513 / IEEE 603 IEC 60880 / IEEE 7.4.3.2 IEC/IEEE 60780-323 IEC/IEEE 60980-344

RELATED PRODUCTS	
DWK 260	Digital wide range processing unit for reactor start-up
IRM/PRM/SRM 510	Intermediate/power/source range monitor



Copyright © 2024 Mirion Technologies, Inc. or its affiliates. All rights reserved. Mirion, the Mirion logo, and other trade names of Mirion products listed herein are registered trademarks or trademarks of Mirion Technologies, Inc. or its affiliates in the United States and other countries. Third party trademarks mentioned are the property of their respective owners.



PROTK™ DIGITAL SIGNAL PROCESSING UNITS

# DAK 260™

## Digital Start-up Channel

### Neutron flux monitoring during reactor start-up.

#### DESCRIPTION

The DAK 260 digital start-up channel forms part of the proTK™ product line.

It is used for monitoring the neutron flux during reactor start-up in the source range with a pulse-type detector or in the intermediate and power range with a gamma-compensated neutron ionization chamber (CIC). With a gamma radiation detector, it can also be used in safety critical radiation or process monitoring applications.

Hardware and software of the DAK 260 channel is designed and qualified for use at the level of the reactor protection system.

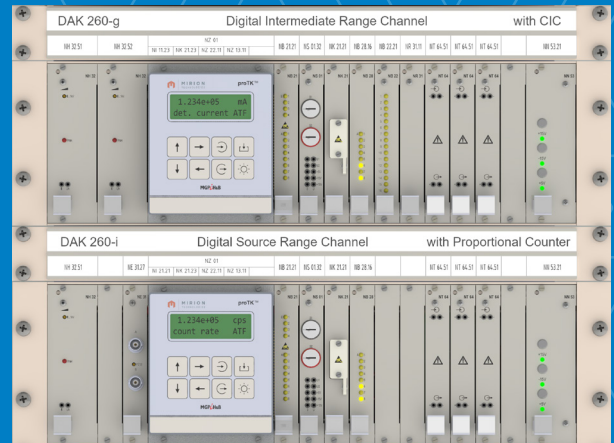

#### FEATURES

- ✓ Modular design, highly customizable
- ✓ For proportional and fission counters or  $\gamma$ -compensated ionization chambers
- ✓ Provides the count rate, calibrated n-flux (nv) or reactor power (%FP, W, ...)
- ✓ Calculation of flux change rate (reciprocal of the reactor period)
- ✓ Signal filtering with adaptive filter parameters
- ✓ Generation of analog output signals with lin. or log. scaling (optional: linear multi-range signal incl. range indication)
- ✓ Generation of binary alarm, trip and status indication signals
- ✓ Remote activation of integrated test signal generators
- ✓ Secured serial interface
- ✓ Qualified for Category A functions (Class 1 systems) acc. IEC 61226

# DAK 260™ START-UP NEUTRON FLUX MONITORING CHANNEL

DIGITAL SIGNAL PROCESSING	
Multi-processor system	
Protected program memory	
Non-volatile parameter memory	
RS-232 and/or RS-485 serial interface for: measurement data, status information and parameter setting	
Internal LC-display: 2 x 16 characters	

OUTPUT SIGNALS	
<b>Log. count rate, neutron flux or reactor power</b>	0.5 ... 5e+5 cps 1E+2 ... 1e+10 nv 1.5E-6 ... 1.5e+2 %FP
<b>Linear count rate (DAK 260-i)</b> <b>Linear power (DAK 260-g)</b>	0 ... 1E+5 cps 0 ... 150 %FP
<b>Relative flux change rate (log rate = 1 / reactor period)</b>	-1.25 ... 0 ... +12.5 %PP/s (equiv. period -80 ... ∞ ... +8 s)
<b>Linear multi-range power signal with range indication</b>	full scale: 125/40/12.5/ ... %FP (16 ranges / half-decades)
<b>Analog outputs</b>	0/4 ... 20 mA / 600 Ω, isolated
<b>Binary outputs (isolated relay changeovers)</b>	60 V / 0.5 A or 125 V / 1 A

The shown scaling of the output signals are examples and can be configured according to the application requirements.

PRE-AMPLIFIERS	
<b>Pulse pre-amplifier NV 320</b>	Characteristic I/O impedance matched to cables (e.g. 50 or 75 Ω)
<b>I/F converter (for ion. chambers) NV 102</b> <b>NV 103</b>	10 decades of meas. range: 1e-13 A ... 1e-3 A 1e-14 A ... 1e-4 A
<b>Integrated test signal generators (pulses, AC and DC)</b>	Activation via HMI or through serial interface.

DETECTORS	
<b>Pulse detectors for DAK 260-i</b>	BF3 or He-3 counter tubes B-10 proportional counters Fission counters
<b>Ionization chambers for DAK 260-g</b>	Gamma compensated or un-compensated neutron ionization chambers (e.g. KNK/KNU 50 ACH)
<b>High voltage supply from HV module(s) in DAK 260</b>	Adjustable within max. range: 0 ... 0.5/1/2/4 kV

OTHER CHARACTERISTICS	
<b>AC / DC power supply</b> <b>230 VAC or 115 VAC</b> <b>18 ... 33 VDC</b>	+10% / -15%, approx. 30 VA
<b>Operating temperature open rack</b> <b>recommended long-term op.</b>	0 ... 70 °C / 32 ... 158 °F 10 ... 40 °C / 50 ... 104 °F
<b>Mechanical vibrations</b>	max. 5 g, 5 ... 100 Hz (or acc. custom requirements)
<b>Dimensions (mm / inch)</b> <b>Rack (W×H×D)</b> <b>Plug-in modules</b>	19" system acc. IEC 60297 483 × 133 × 280 / 19 x 5.2 x 11 100 × 160 / 3.9 x 6.3

QUALIFICATION / DESIGN STANDARDS (SELECTION)	
<b>Design</b>	IEC 61513 / IEEE 603
<b>Software</b>	IEC 60880 / IEEE 7.4.3.2
<b>Qualification</b>	IEC/IEEE 60780-323 IEC/IEEE 60980-344

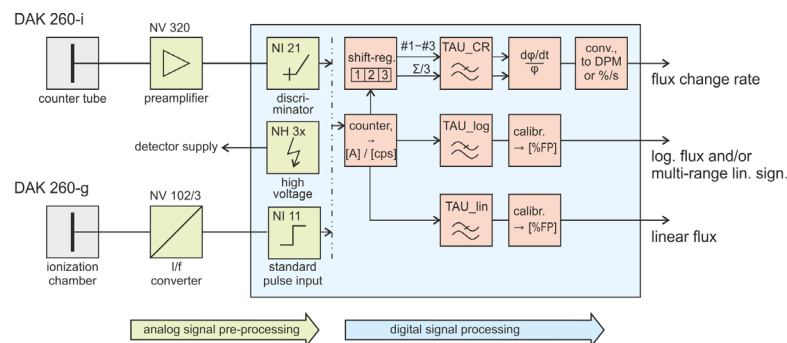

Copyright © 2023 Mirion Technologies, Inc. or its affiliates. All rights reserved. Mirion, the Mirion logo, and other trade names of Mirion products listed herein are registered trademarks or trademarks of Mirion Technologies, Inc. or its affiliates in the United States and other countries. Third party trademarks mentioned are the property of their respective owners.





PROTK™ DIGITAL SIGNAL PROCESSING UNITS

# DGK 260™

## Digital Power Range Channel

Neutron flux monitoring during power operation.

### DESCRIPTION

The DGK 260 digital power range channel forms part of the proTK™ product line.

It measures the neutron flux and reactor power in the power range, in combination with neutron ionization chambers. In addition, a fast current output signal, directly from the input amplifier is provided for external systems that monitor for characteristic fluctuations (noise) on the current signal.

Hardware and software of the DGK 260 channel is designed and qualified for applications at the level of the reactor protection system.

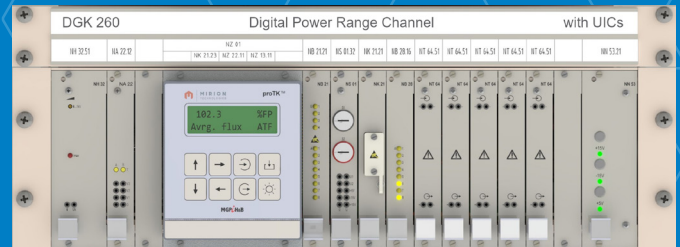

### FEATURES

- ✓ Modular design, highly customizable
- ✓ Two individual signal paths for ionization chambers
- ✓ Calculation of mean value, axial deviation and linear change rate
- ✓ Independent calibration of output signals (nv, P/Pn)
- ✓ Optional signal filtering with fixed time constant
- ✓ Generation of analog signals with linear scaling, binary alarms, trip and status indication signals
- ✓ Fast response times (< 15 ms without filtering)
- ✓ Remote activation of integrated test signal generators
- ✓ Secured serial interface
- ✓ Qualified for Category A functions (Class 1 systems) acc. IEC 61226

# DGK 260™ POWER RANGE NEUTRON FLUX MONITORING CHANNEL

DIGITAL SIGNAL PROCESSING	
Multi-processor system	
Protected program memory	
Non-volatile parameter memory	
RS-232 and/or RS-485 serial interface for: measurement data, status information and parameter setting	
Internal LC-display: 2 x 16 characters	

OUTPUT SIGNALS	
<b>Top / bottom and average neutron flux or reactor power</b>	Linear scaling: 0 ... 1e+10 nv 0 ... 125 %FP
<b>Axial deviation (top / bottom)</b>	-30 ... +30 %FP
<b>Linear rate signal</b>	-10 ... 0 ... +10 %FP/s
<b>Analog outputs</b>	0/4 ... 20mA / 600 Ω, isolated
<b>Binary outputs (isolated relay changeovers)</b>	60V / 0.5A or 125V / 1A

The shown scaling of the output signals are examples and can be configured according to the application requirements.

DETECTORS	
<b>Ionization chambers</b>	Gamma compensated or un-compensated neutron ionization chambers (e.g. KNK/KNU 50 ACH)
<b>High voltage supply from HV modules in DGK 260</b>	Adjustable within max. range: 0 ... 0.5/1/2/4 kV

OTHER CHARACTERISTICS	
<b>AC / DC power supply</b> 230 VAC or 115 VAC 18 ... 33 VDC	+10% / -15%, approx. 30 VA
<b>Operating temperature</b> open rack recommended long-term op.	0 ... 70 °C / 32 ... 158 °F 10 ... 40 °C / 50 ... 104 °F
<b>Mechanical vibrations</b>	max. 5 g, 5 ... 100 Hz (or acc. custom requirements)
<b>Dimensions (mm / inch)</b> Rack (W×H×D) Plug-in modules	19" system acc. IEC 60297 483 × 133 × 280 / 19 x 5.2 x 11 100 × 160 / 3.9 x 6.3

QUALIFICATION / DESIGN STANDARDS (SELECTION)	
<b>Design</b>	IEC 61513 / IEEE 603
<b>Software</b>	IEC 60880 / IEEE 7.4.3.2
<b>Qualification</b>	IEC/IEEE 60780-323 IEC/IEEE 60980-344

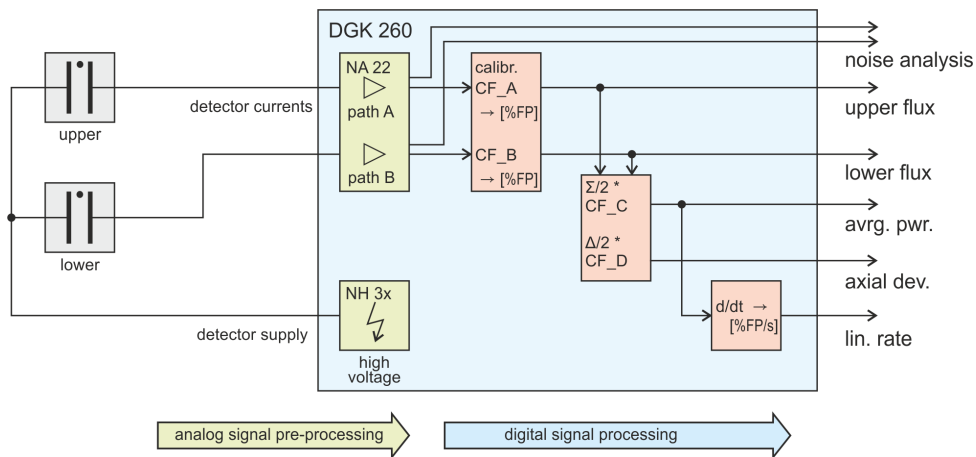

Copyright © 2023 Mirion Technologies, Inc. or its affiliates. All rights reserved. Mirion, the Mirion logo, and other trade names of Mirion products listed herein are registered trademarks or trademarks of Mirion Technologies, Inc. or its affiliates in the United States and other countries. Third party trademarks mentioned are the property of their respective owners.



PROTK™ DIGITAL SIGNAL PROCESSING UNITS

# DWK 260™

## Digital Wide Range Channel

Neutron flux monitoring over the full range with one wide range fission chamber.

### DESCRIPTION

The DWK 260 digital wide range channel forms part of the proTK™ product line. It has been designed for continuous neutron flux monitoring during all reactor operation modes.

The DWK 260 monitor provides information on the neutron flux, the reactor power and the rate of change of the neutron flux. In addition, it provides binary alarm and reactor trip signals based on the measured neutron flux and user adjustable thresholds. Analog and binary output signals of the highest safety class are available and can be used at the level of the reactor protection system.

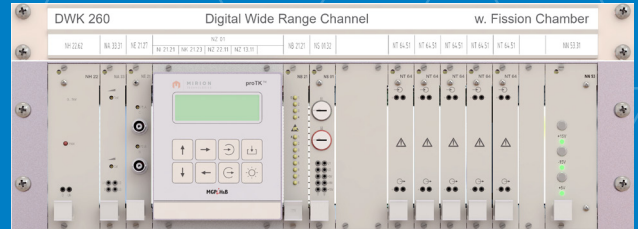

### FEATURES

- ✓ Modular design, highly customizable
- ✓ 10+ decades of neutron flux range coverage with one fission chamber
- ✓ Calibration of signal into units of neutron flux (nv) or reactor power (%FP, W,...)
- ✓ Seamless calculation of the relative flux change rate (reciprocal of the reactor period) over the full neutron flux range
- ✓ Signal filtering with adaptive filter parameters
- ✓ Generation of analog output signals with linear or logarithmic scaling
- ✓ Generation of binary alarm, trip and status indication signals
- ✓ Integrated test-signal generators and simulation capabilities
- ✓ Secured serial interface
- ✓ Qualified for Category A functions (Class 1 system) acc. IEC 61226

# DWK 260™ WIDE RANGE NEUTRON FLUX MONITORING CHANNEL

DIGITAL SIGNAL PROCESSING	
Multi-processor system	
Protected program memory	
Non-volatile parameter memory	
RS-232 and/or RS-485 serial interface for: measurement data, status information and parameter setting	
Internal LC-display: 2 x 16 characters	

OUTPUT SIGNALS	
<b>Pulse count rate (logarithmic)</b>	0.5 ... 5e+5 cps
<b>Campbell (AC/MSV) signal</b>	> 7 decades
<b>Wide range signal (logarithmic power)</b>	1 ... 1e+10 nv, 1.5e-8 ... 150 %FP
<b>Relative flux change rate (log rate = 1 / reactor period)</b>	-3.33 ... 0 ... +33.3 %/s (equiv. period -30 ... ∞ ... +3 s)
<b>Linear DC signal (linear power)</b>	0 to 150 %FP
<b>Linear rate signal</b>	-10 ... 0 ... +10 %FP/s
<b>Analog outputs</b>	0/4 ... 20 mA / 600 Ω, isolated
<b>Binary outputs (isolated relay change overs)</b>	60 V / 0.5 A or 125 V / 1 A

The shown scaling of the output signals are examples and can be configured according to the application requirements.

PRE-AMPLIFIERS	
<b>Type</b>	Available for guarded or un-guarded fission chambers
<b>Processing</b>	Pulses, MSV (Campbell) and DC signals
<b>Integrated test signal generators (pulses, AC and DC)</b>	Activation via HMI or through serial interface.

DETECTORS	
<b>Wide-range fission chamber</b>	In- / ex-core Fission Chambers (guarded or un-guarded)
<b>Integral cables / connectors mineral insulated cables connectors</b>	Coaxial or triaxial design Optional, up to 20 m / 66 ft HN-type (others on request)
<b>Extension cables / connectors organic cables connectors</b>	Coaxial or triaxial design Up to 100 m / 328 ft HN-type (others on request)
<b>High voltage supply from HV module in DWK 260</b>	e.g. 0 ... 0.5 or 1 kV
<b>Thermal neutron sensitivity pulse mode DC mode</b>	On request e.g. 1e-3 cps/nv, 0.7 cps/nv e.g. 1e-17 A/nv, 1e-14 A/nv

OTHER CHARACTERISTICS	
<b>AC / DC power supply 230 VAC or 115 VAC 18 ... 33 VDC</b>	+10% / -15%, approx. 30 VA
<b>Characteristic impedance of pre-amplifier I/Os</b>	Matched to the cable typ. 50 or 75 Ω
<b>Operating temperature open rack recommended long-term op.</b>	0 ... 70 °C / 32 ... 158 °F 10 ... 40 °C / 50 ... 104 °F
<b>Mechanical vibrations</b>	max. 5 g, 5 ... 100 Hz (or acc. custom requirements)
<b>Dimensions (mm / inch) Rack (W×H×D) Plug-in modules</b>	19" system acc. IEC 60297 483 × 133 × 280 / 19 × 5.2 × 11 100 × 160 / 3.9 × 6.3

QUALIFICATION / DESIGN STANDARDS (SELECTION)	
<b>Design</b>	IEC 61513 / IEEE 603
<b>Software</b>	IEC 60880 / IEEE 7.4.3.2
<b>Qualification</b>	IEC/IEEE 60780-323 IEC/IEEE 60980-344

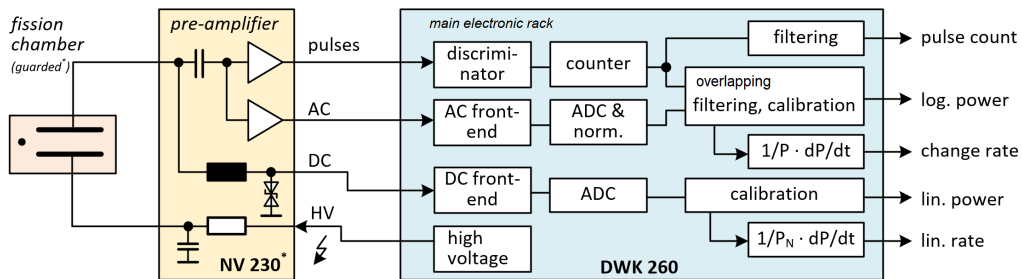

\* for un-guarded fission chambers the pre-amplifier NV 231 is available



Copyright © 2023 Mirion Technologies, Inc. or its affiliates. All rights reserved. Mirion, the Mirion logo, and other trade names of Mirion products listed herein are registered trademarks or trademarks of Mirion Technologies, Inc. or its affiliates in the United States and other countries. Third party trademarks mentioned are the property of their respective owners.



PROTK™

# KNK/KNU 50 ACH™

## γ-Compensated/Uncompensated

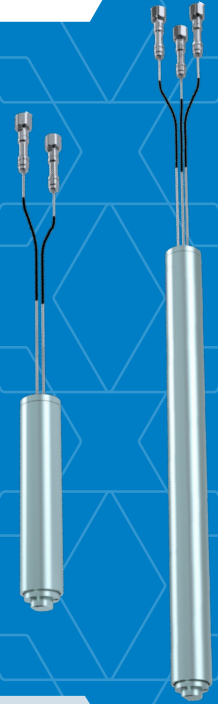

### Neutron flux detectors for the intermediate and power range

#### DESCRIPTION

The neutron ionization chambers of type KNK 50 ACH and KNU 50 ACH are designed for measuring the neutron flux outside the reactor core during reactor start-up and power operation, respectively.

The detector signal consists of a current that is proportional to the thermal neutron flux at the detector position. The electrical current is generated by the lithium nuclei and the  $\alpha$  particles resulting from the  $B\ 10(n, \alpha) Li\ 7$  reactions inside the homogeneously distributed B 10 layer. Either of the two positively charged nuclei is entering the gas-filling of the chamber causing secondary ionizations that are collected at the electrodes with the help of the applied bias voltage. The resulting DC signal can be measured through an external electronic circuit.

#### FEATURES

- ✓ Wide thermal neutron flux range from  $10^2$  to  $10^{10}$  nv
- ✓ Robust design, uniform sensitivity
- ✓ Detector available with sensitivity from  $(0.7\ \text{to}\ 4.4) \times 10^{-14}$  A/nv
- ✓ No organic materials and therefore suitable for long-term operation in high radiation environment
- ✓ Saturation proof over entire neutron flux range
- ✓ Intrinsic gamma compensation (KNK 50 ACH)
- ✓ Integral MI cable with or w/o PEEK layer for mechanical protection and electrical insulation
- ✓ Variant with transition/splice to organic cable available (KNU/KNK 50 ASH)
- ✓ Accident/LOCA proof (KNK 50 ACH/ASH)



# KNK/KNU 50 ACH™ NEUTRON IONIZATION CHAMBERS

## SPECIFICATIONS AND PERFORMANCE

Type	Product Code	Sensitivity (A/nv) x 10 <sup>-14</sup>	Operation/ Compensation Voltage (V DC)	Neutron Flux Range (nv)	Total/Sensitive Length (mm)	Integral Cables /HN Connectors
<b>γ-compensated (CIC)</b>	KNK 50-1 ACH	0.7	+800/0 to -500 (CIC)	10 <sup>2</sup> to 10 <sup>10</sup>	255/80	3 MI cables + HN (male) connectors
<b>γ-compensated (CIC)</b>	KNK 50-6 ACH	...				
<b>Uncompensated (UIC)</b>	KNU 50-1 ACH KNU 50-6 ACH	4.4			705/530	2 MI cables + HN (male) connectors

For specific applications and for receiving further technical data related to these and more detectors, please contact Mirion.

MATERIALS	
Filling gas/pressure	N <sup>2</sup> /1 bar
Detector housing and HV electrodes	Al
Detector/cable isolators	Al <sub>2</sub> O <sub>3</sub> /MgO
Integral cable outer sheath	Stainless steel, OD = 4 mm
Optional cable protection and electrical isolation	PEEK, OD = 4.7 mm

proTK™ SIGNAL PROCESSING UNITS AND MONITORS	
<p><b>Suitable signal processing units for KNK/KNU 50 ACH neutron ionization chambers:</b></p> <p><b>DAK 260-g + NV 102</b></p>   <p><b>DGK 260-g</b></p> 	<p>Mirion can provide the complete neutron flux monitoring system for reactor start-up and power operation.</p> <p>Digital start-up signal processing unit for the intermediate range DAK 260-g with current-to-frequency converter NV 102 for use with a KNK 50 ACH.</p> <p>See also corresponding intermediate range neutron flux monitor IRM 510.</p> <p>Digital signal processing unit for the power range for use with up to two (2) KNU 50 ACH.</p> <p>See also corresponding neutron flux monitor for the power range PRM 510.</p>

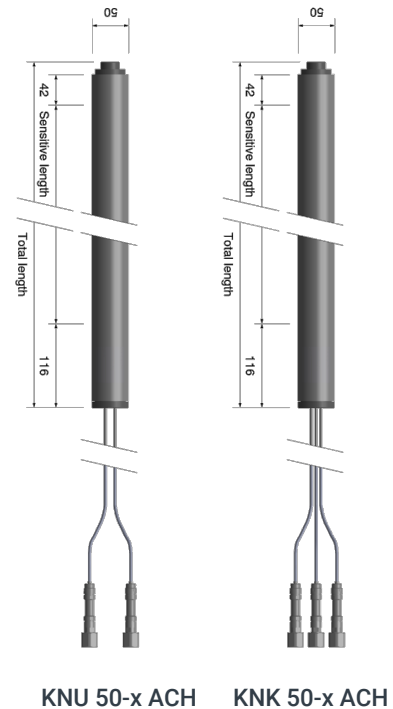
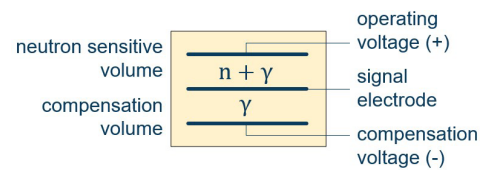

Copyright © 2024 Mirion Technologies, Inc. or its affiliates. All rights reserved. Mirion, the Mirion logo, and other trade names of Mirion products listed herein are registered trademarks or trademarks of Mirion Technologies, Inc. or its affiliates in the United States and other countries. Third party trademarks mentioned are the property of their respective owners.



PROTK™

# PN 25/PN 50™

## B-10 Proportional Counters

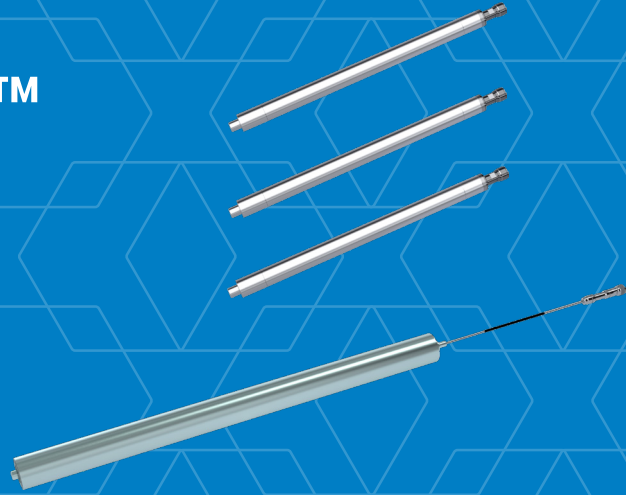

### Neutron flux detectors for the source range

#### DESCRIPTION

The B 10 proportional counters of type PN 25 and PN 50 are designed to measure the neutron flux outside the reactor core in the source range during reactor start-up. The detector signal consists of charge pulses that are generated in the active gas volume of the B 10 proportional counter by either the lithium nucleus or the alpha particle resulting from the B 10 (n,  $\alpha$ ) Li 7 reaction.

These detectors are available with a neutron sensitivity of 4.5 cps/nv for the PN 25 and from 5 to 15 cps/nv depending on the sensitive length for the PN 50. The typical thermal neutron flux range covered with these detectors is therefore approx. 0.1 nv to 3E+5 nv.

#### FEATURES

- ✓ Wide thermal neutron flux range
- ✓ Robust design, uniform sensitivity
- ✓ High temperature range (up to 200 °C)
- ✓ Available in various lengths with sensitivities up to 15 cps/nv
- ✓ Connectorized (HN connectors) or with integral mineral insulated cable (PN 50)
- ✓ Suitable for long-term operation in high radiation environment (w/o organic materials)
- ✓ Integral MI cable with PEEK layer for mechanical protection and electrical insulation (PN 50)
- ✓ Environmental and seismic qualification

# PN 25/PN 50™ B-10 PROPORTIONAL COUNTERS

## SPECIFICATIONS AND PERFORMANCE

Product Code	Sensitivity (cps/nv)	Operation Voltage (V DC)	Neutron Flux Range (nv)	Total/Sensitive Length (mm)	Diameter (mm)	Integral MI Cable/Impedance	Connector
PN 25	4.5	+700 ... +850	0.1 ... 2e+5	417/290	25	-	HN (female)
PN 50-2	5	+600 ... +900	0.1 ... 3e+5	379/180	50	max. 15 m/ 50 Ω	HN (female)
PN 50-4	10		0.1 ... 2e+5	559/360			
PN 50-6	15		0.1 ... 1e+5	739/540			

For specific applications and for receiving further technical data related to these and more detectors, please contact Mirion.

ENVIRONMENTAL DATA	
Operating temperature, humidity	Max. 200 °C, 100% r.H.
Ambient pressure (absolute)	0 ... 800 kPa
Gamma dose rate (Cs-137)	< 10 Gy/h
Neutron fluence, γ TID (detector and cable/connector)	2E+19 nvt > 200/> 4 MGy

MATERIALS	
Filling gas/pressure	Ar + CO <sub>2</sub> /30 kPa
Detector housing and HV electrodes	Al, Al-Mg-alloy
Detector, Cable isolators	Al <sub>2</sub> O <sub>3</sub> SiO <sub>2</sub> (PN 50)
Integral cable outer sheath, with isolation protection (optional)	Stainless steel, OD = 4 mm PEEK, OD = 4.7 mm

proTK™ SIGNAL PROCESSING UNITS AND MONITORS	
<p><b>Suitable signal processing unit for the proportional counters PN 25 and PN 50:</b></p> <p><b>DAK 260-i + NV 320</b></p> 	<p>Mirion can provide the complete neutron flux monitoring system for reactor start-up.</p> <p>In the source range the digital start-up signal processing unit DAK 260-i with the pulse pre-amplifier NV 320 is used with a PN 25 or PN 50 (other proportional counters are equally suitable).</p> <p>See also corresponding source range neutron flux monitor SRM 510.</p>

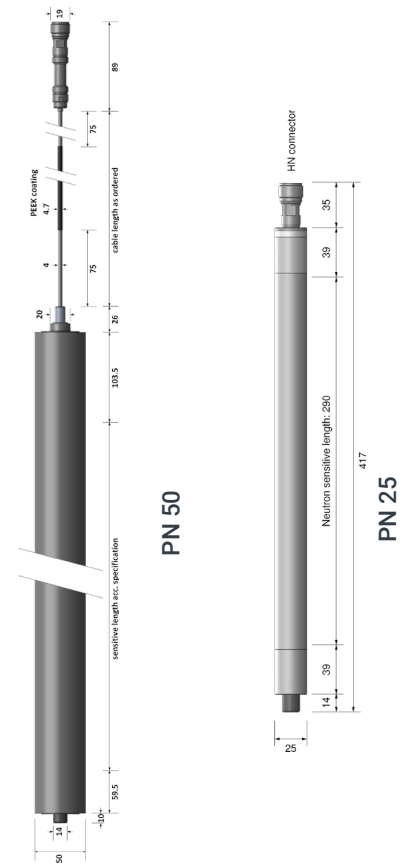

Copyright © 2024 Mirion Technologies, Inc. or its affiliates. All rights reserved. Mirion, the Mirion logo, and other trade names of Mirion products listed herein are registered trademarks or trademarks of Mirion Technologies, Inc. or its affiliates in the United States and other countries. Third party trademarks mentioned are the property of their respective owners.





NUCLEAR CONTAINMENT SEALS

# EPA

## Electric Penetration Assembly

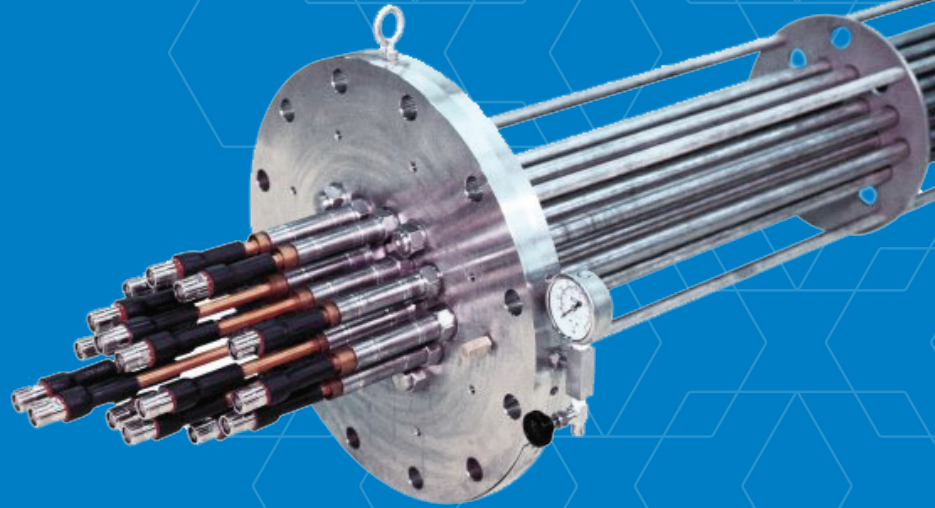

### DESCRIPTION

Mirion Technologies Electric Penetration Assemblies (EPAs) provide the electrical and signal capabilities required inside containment, while maintaining the containment pressure boundary during normal and accident conditions. There are several designs to choose from to meet the needs of all power plants.

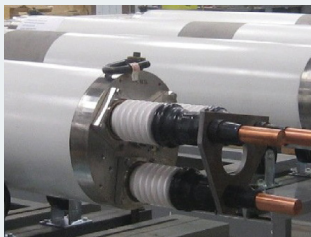

Canister Design,  
Medium Voltage Power  
(5kV through 15kV)

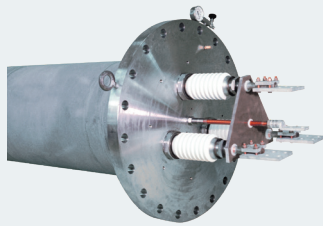

Medium Voltage Power  
(5kV through 15kV)

### DESIGNS

- ✓ Epoxy Module
- ✓ Swaged Modular
- ✓ Swaged Canister

### SERVICE CLASS

- ✓ Instrumentation
- ✓ Medium voltage power
- ✓ Low voltage power
- ✓ Low voltage instrumentation
- ✓ Low voltage control

### FEATURES

- ✓ Stainless Steel pressure boundary headerplate of ASME B & PV Code material and design
- ✓ Modular conductor feedthrough
- ✓ Metal-to-metal seal of the conductor feedthrough module to the EPA headerplate
- ✓ Feedthrough tube provides complete mechanical protection
- ✓ Dual seals for integral leak monitoring system
- ✓ Does not require nitrogen pressurization gas to maintain containment integrity
- ✓ Continuous, fully insulated, solid copper conductors from inboard to outboard
- ✓ Sealants in the feedthrough eliminate the possibility of voids, cracks and moisture intrusion
- ✓ 100% copper shielding of coax and triax signal conductors

## ELECTRIC PENETRATION ASSEMBLY (EPA) NUCLEAR CONTAINMENT SEALS

### HISTORY

- More than 17,000 EPA installed worldwide in over 300 power plants
- Suppliers of equipment in the Nuclear Power Industry since 1952
- ASME Boiler & Pressure Vessel Code, NPT Stamp and N Stamp certification since 1974

### SERVICE CONDITIONS

- 60 year normal service temperature: 150 °F (65 °C)
- Higher temperatures can be accommodated with an adjustment in ampacity
- Design basis temperature MSLB: Excess of 420 °F (216 °C)
- Design basis temperature LOCA: Excess of 340 °F (171 °C)
- Design basis pressure: 75 PSIG (517 kPa)
- Severe accident temperature/pressure: 700 °F (371 °C)/120 PSIG (829 kPa) for ten (10) days

- Radiation tolerance: 500 Mrads (5 MGy); gamma; 4,100 M Rads, beta
- Qualification reports to verify plant-specific temperature, pressure and chemical spray conditions, with the requirements of IEEE-317, for 60 year service life

### QUALIFICATIONS

- ASME Boiler and Pressure Vessel Code (NPT Stamp) for Section III, Subsection NE, and Class MC manufacturing
- Qualified by test to the current standards of IEEE-317, IEEE-323, IEEE-344, IEC Publication IEG-60772, and KTA-3404
- Quality Assurance Program meets the requirements of 10CFR50, Appendix B, and ANSI/ASME NQA-1
- Equipment is provided with: Qualification Test Reports, Material Certifications, ASME Design Stress Reports, Drawings and Procedures
- Audited by: NUPIC, NIAC, NRC

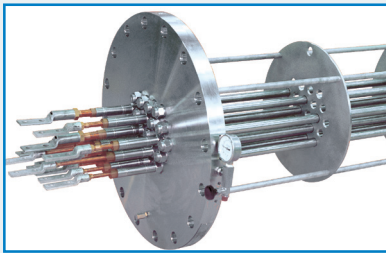

Swaged Construction, Low Voltage Power with NEMA spade connectors



Epoxy Construction, Instrumentation

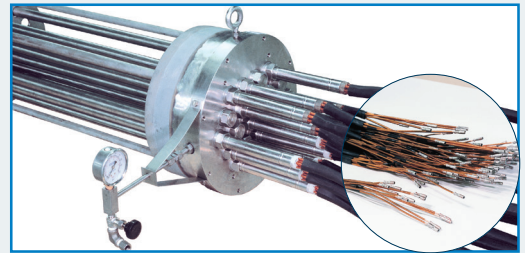

Swaged Construction, Low Voltage Instrumentation and Control with in-line butt splice connectors

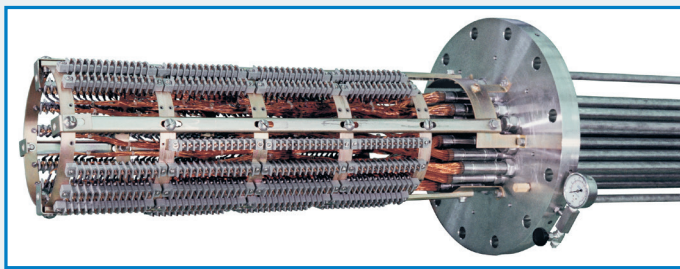

Swaged Construction, Instrumentation and Control with Squirrel Cage Assembly

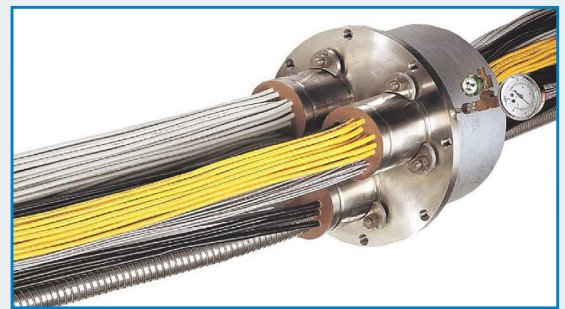

Epoxy Construction, Low Voltage Control



**MIRION**  
TECHNOLOGIES

Copyright © 2024 Mirion Technologies, Inc. or its affiliates. All rights reserved. Mirion, the Mirion logo, and other trade names of Mirion products listed herein are registered trademarks or trademarks of Mirion Technologies, Inc. or its affiliates in the United States and other countries. Third party trademarks mentioned are the property of their respective owners.



NUCLEAR CONTAINMENT SEALS

# Fiber Optic

## Feedthroughs



### DESCRIPTION

Mirion Technologies Fiber Optic feedthroughs allow data to be transmitted over longer distances at a faster rate. Fiber Optic feedthroughs can be used in new penetrations or retrofitted in existing Electric Penetration Assemblies (EPA).

### QUALIFICATIONS

- ✓ Qualified by test to the current standards of IEEE-317
- ✓ Radiation resistance:  $2.25 \times 10^9$  rads Gamma
- ✓ Seismically qualified for RRS of 10 G's OBE, 15 G's SSE at 2% damping
- ✓ DBE peak of 405 °F (207 °C) at 80 psig and a chemical spray of boron, sodium hydroxide and hydrazine for an initial pH of 11.0
- ✓ Quality Assurance Program meets the requirements of 10CFR50, Appendix B, and ANSI/ASME NQA-1
- ✓ Qualified for containment pressure boundary and non-1E applications

### FEATURES

- ✓ 1.0" diameter stainless steel feedthrough
- ✓ Eight (8) continuous fibers per assembly
- ✓ Multi and Single modes available
- ✓ Silica core and cladding with a Pyrocat buffer
- ✓ Graded Index multi-mode fibers available with 50 $\mu$ , 62.5 $\mu$ , and 100 $\mu$  silica cores.
- ✓ Single mode fibers typically with a 8.9 $\mu$  silica core
- ✓ Pigtailed protected by polyolefin heatshrink, inside a stainless steel monocoil, flexible tubing
- ✓ Pigtail lengths range from 4 to 100 feet on either side of the feedthrough module
- ✓ Pigtailed are terminated with optical connectors at the factory
- ✓ Connectors can be type ST, SC, LC or as specified

### APPLICATIONS

- ✓ Permanent video
- ✓ Telecommunications and computer links for Health Physics data from inside containment

**FIBER OPTIC FEEDTHROUGHS NUCLEAR CONTAINMENT SEALS**



Canister Design Fiber Optic Feedthrough



Braided Assembly for Ruggedized Covering of Fiber Optic Cables

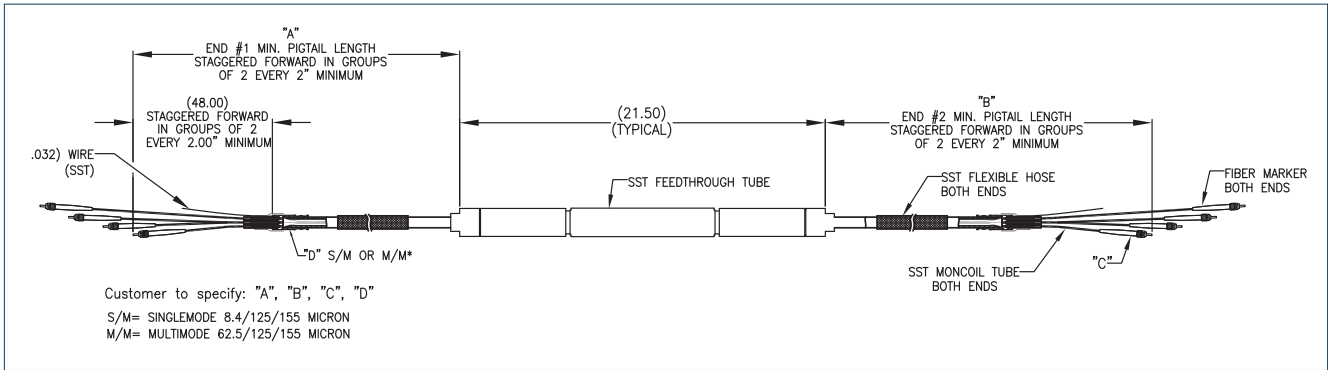

Diagram of Fiber Optic Feedthrough



**MIRION**  
TECHNOLOGIES

Copyright © 2024 Mirion Technologies, Inc. or its affiliates. All rights reserved. Mirion, the Mirion logo, and other trade names of Mirion products listed herein are registered trademarks or trademarks of Mirion Technologies, Inc. or its affiliates in the United States and other countries. Third party trademarks mentioned are the property of their respective owners.



# ECSA

## Electric Conductor Seal Assembly



### DESCRIPTION

Mirion Technologies Electric Conductor Seal Assemblies (ECSAs) allow interfacing with customers' equipment and can be used anywhere that sealing of conductors is required, inside or outside containment. Mirion has supplied over 35,000 ECSAs to nuclear power plants worldwide.

### FEATURES

- ✓ Metal-to-metal sealing technology
- ✓ Solid copper conductors from end to end
- ✓ No internal splicing
- ✓ No epoxies
- ✓ Stainless steel sealing components
- ✓ Technical and engineering support

### APPLICATIONS

- ✓ Resistance Temperature Detectors
- ✓ Thermocouples
- ✓ Limit switches
- ✓ Solenoid valves
- ✓ Pressure transmitters
- ✓ Motor operated valves
- ✓ Level sensors
- ✓ Works with any Class 1E devices requiring sealed conductors

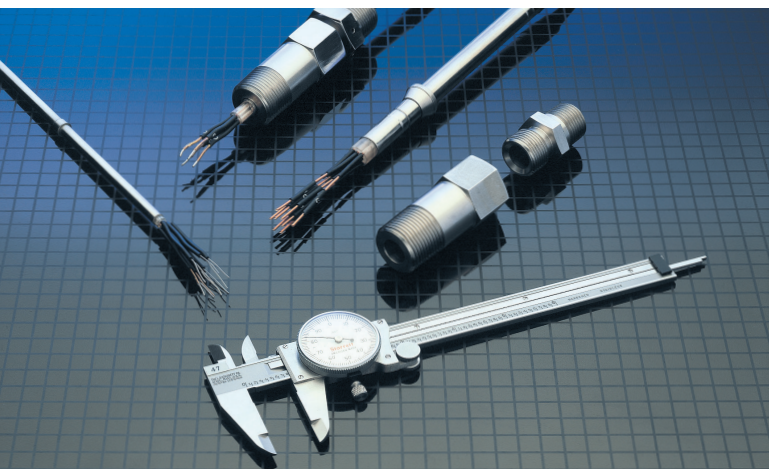

**ECSA ELECTRIC CONDUCTOR SEAL ASSEMBLY**

**QUALIFICATIONS**

- Qualified by test to the current standards of IEEE-317, IEEE-323, IEEE-344 and IEEE-572
- Quality Assurance Program meets the requirements of 10CFR50, Appendix B, and ANSI/ASME NQA-1



Electric Conductor Seal Assembly (ECSA)

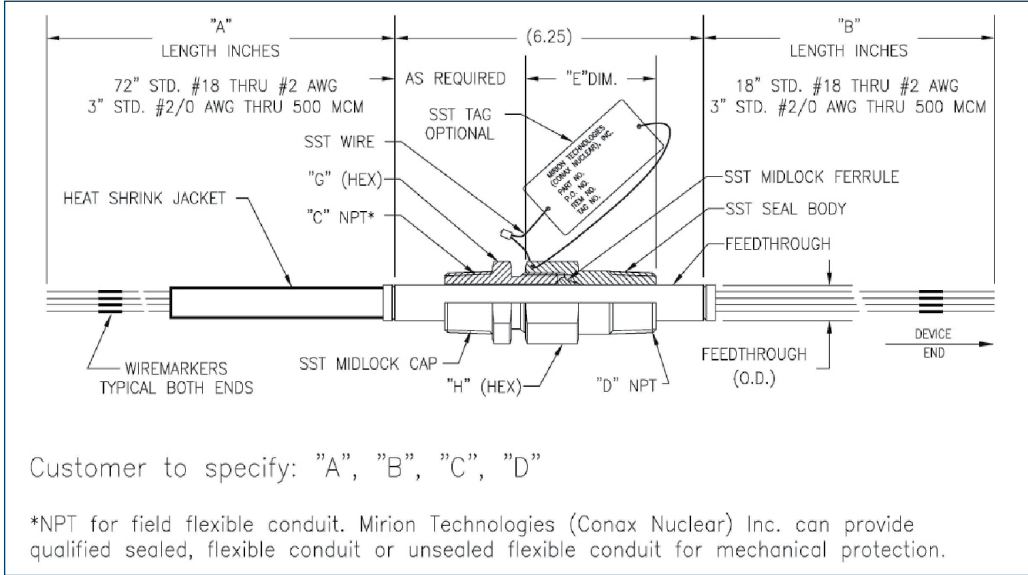

Diagram of Electric Conductor Seal Assembly (ECSA)

Standard ECSA Feedthrough Density Table					
CONDUCTOR SIZE	MAXIMUM NUMBER OF CONDUCTORS PER FEEDTHROUGH SIZE				RATED CONTINUOUS CURRENT (AMPS)
	0.375"	0.500"	0.750"	1.000"	
#18AWG	4	12	30	42	-
#16AWG	4	6	20	36	11
#14AWG	2	4	20	30	12
#12AWG	-	4	13	24	16
#10AWG	-	4	9	19	22
#8AWG	-	-	6	12	28
#6AWG	-	-	4	9	41
#4AWG	-	-	3	6	55
#2AWG	-	-	-	3	74
#2/0 AWG	-	-	1	1	116
250 MCM	-	-	-	1	174
500 MCM	-	-	-	1	270
Coaxial/Triaxial	-	-	1	1	-

\*At 135 °F (57 °C)  
Single circuit application only



Copyright © 2024 Mirion Technologies, Inc. or its affiliates. All rights reserved. Mirion, the Mirion logo, and other trade names of Mirion products listed herein are registered trademarks or trademarks of Mirion Technologies, Inc. or its affiliates in the United States and other countries. Third party trademarks mentioned are the property of their respective owners.



NUCLEAR CONTAINMENT SEALS

# NSC

## Nuclear Service Connector



### DESCRIPTION

Mirion Technologies Nuclear Service Connectors (NSCs) offer quick, reliable disconnect and reconnect, and eliminate costly cut and splice procedures.

Metal-to-metal seals eliminate organic “O” rings and gaskets, ending seal replacement maintenance.

Standard designs allow for retrofit into existing Class 1E applications and provide direct field termination to MI cable, sensor or instrument device housing. All metal components are constructed of 316 stainless steel.

### FEATURES

- ✓ Radiation resistance:  $2.25 \times 10^8$  Rads
- ✓ Normal service temperature ambient: 225 °F (107.2 °C)
- ✓ Design pressure: 75 psig (517 kPa)
- ✓ Seismic horizontal and vertical RRS, up to 15 G's SSE
- ✓ Design basis event:
  - Loss of Coolant Accident (LOCA)
  - Main Steam Line Break (MSLB)
- ✓ Minimal personnel radiation exposure time



Multi-pin NSC

## NUCLEAR SERVICE CONNECTOR (NSC) NUCLEAR CONTAINMENT SEALS

### NSC CERTIFICATION AND QUALIFICATION

- Class 1E Qualified
  - IEEE-323
  - IEEE-344
  - IEEE-572
- Manufactured under ANSI/ASME NQA-1 and 10 CFR 50/Appendix-B quality program
- 10 CFR 21 accepted
- Audited by: NUPIC, NIAC, NRC

### APPLICATIONS

- Resistance Temperature Detectors (RTDs)
- Thermocouples
- Limit switches
- Solenoid valves
- Pressure transmitters
- Motor operated valves
- Level sensors
- Any Class 1E devices requiring sealed conduit entrance

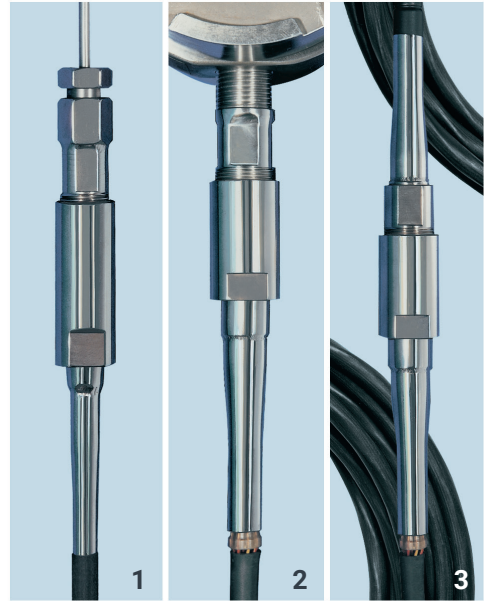

1. Flexible cable to sensor or MI cable
2. Flexible cable to device
3. Flexible cable to flexible cable



Multi-pin NSC

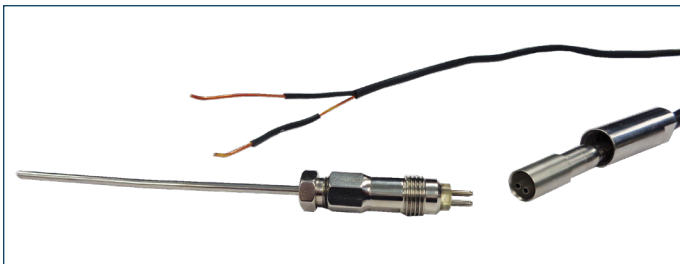

2 Pin NSC with Thermocouple



NSC with RTD (Resistance Temperature Detector)

*Technical Support Available*



Copyright © 2024 Mirion Technologies, Inc. or its affiliates. All rights reserved. Mirion, the Mirion logo, and other trade names of Mirion products listed herein are registered trademarks or trademarks of Mirion Technologies, Inc. or its affiliates in the United States and other countries. Third party trademarks mentioned are the property of their respective owners.





# Nuclear Service Temperature Sensor

## Mirion sensors



### DESCRIPTION

Mirion Technologies Nuclear Service Temperature Sensors are categorized by Resistance Temperature Detectors (RTD) and Thermocouples (T/C). Mirion Technologies sensors are designed and manufactured to comply with the harsh requirements of in-containment applications.

Our field cable termination connections can mate to terminal blocks in a termination head with a Class 1E conductor seal, or spliced directly to pigtails. These sensors are perfect for applications requiring nuclear plant temperature readings.

### RTD CONFIGURATIONS

- ✓ Single or dual elements
- ✓ 100 or 200 Ohm platinum elements
- ✓ 3 or 4 wire

### T/C CONFIGURATIONS

- ✓ Single or dual junctions
- ✓ Available in standard Type T, J, E and K
- ✓ Customized to customer requirements



## SENSORS RESISTANCE TEMPERATURE DETECTOR (RTD) AND THERMOCOUPLE (T/C)

### FEATURES

- Unique swaged construction
- Resilient sealants protect sensor element against Loss of Coolant Accident (LOCA) event hazards
- Fast response designs
- Single or dual elements
- Calibrated to industry standards
- Technical support available

### TERMINATION TYPES

- Quick disconnect
- Unitized
- Stainless steel terminal block head

### APPLICATIONS

- Fast response reactor coolant system, inlet and outlet
- Containment atmosphere
- Pressurizer relief lines
- Hydrogen recombiner outlet and burn chamber
- Differential pressure compensation systems
- Suppression pool

### QUALIFICATIONS

- Qualified by test to the current standards of IEEE-317, IEEE-323 and IEEE-344
- Quality Assurance Program meets the requirements of 10CFR50 Appendix B, and ANSI/ASME NQA-1
- LOCA



RTD with integral NSC (Nuclear Service Connector)

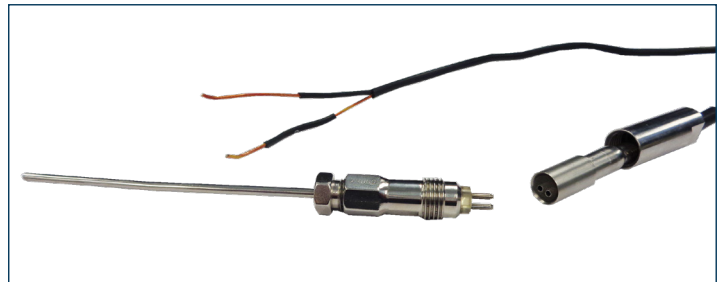

Thermocouple with NSC (Nuclear Service Connector)



**MIRION**  
TECHNOLOGIES

Copyright © 2024 Mirion Technologies, Inc. or its affiliates. All rights reserved. Mirion, the Mirion logo, and other trade names of Mirion products listed herein are registered trademarks or trademarks of Mirion Technologies, Inc. or its affiliates in the United States and other countries. Third party trademarks mentioned are the property of their respective owners.



NUCLEAR CONTAINMENT SEALS

# Special Purpose Valve

## Explosive Actuated Squib

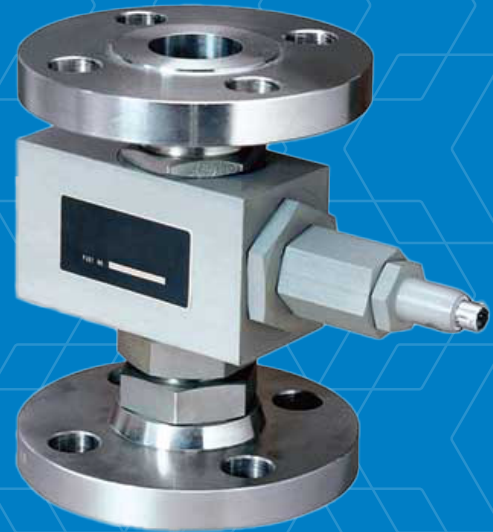

### APPLICATIONS

- ✓ Standby Liquid Control (SLC)
- ✓ Main Steam Isolation Valve (MSIV)
- ✓ Instrumentation cable cut/seal
- ✓ Pressure relief
- ✓ Passive injection systems

### DESCRIPTION

Mirion Technologies Special Purpose Valves (Explosive Actuated Squib valves) provide extremely fast response, superb reliability, and zero leakage wherever instant or emergency operation is needed.

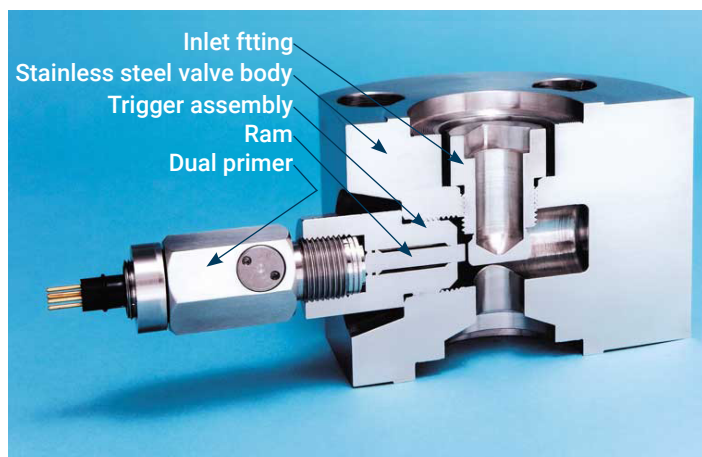

## SPECIAL PURPOSE VALVE EXPLOSIVE ACTUATED SQUIB

### QUALIFICATIONS

- Qualified by test to the current standards of IEEE-323 & IEEE-344
- Quality Assurance Program meets the requirements of 10CFR50, Appendix B, and ANSI/ASME NQA-1
- Available with the ASME "N" Stamp Certification to the ASME Boiler and Pressure Vessel Code to Section III, division 1, Class 1 Sub-Section "NB".

### FEATURES

- Dual primer
- Extremely fast response: 0.002 seconds
- Zero leakage
- Parent metal sealing
- Reliability exceeding 99%
- Circuit integrity can be verified by firing system
- Low current actuation
- Technical and Engineering Support Available

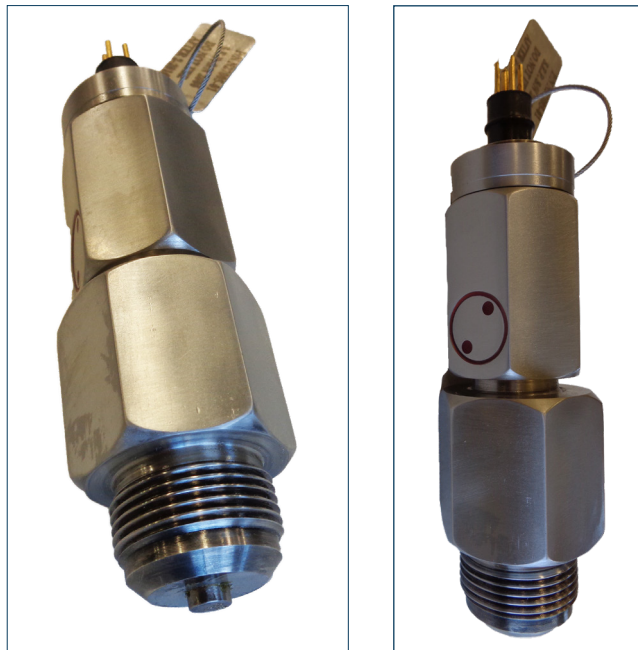

Trigger Assembly



**MIRION**  
TECHNOLOGIES

Copyright © 2024 Mirion Technologies, Inc. or its affiliates. All rights reserved. Mirion, the Mirion logo, and other trade names of Mirion products listed herein are registered trademarks or trademarks of Mirion Technologies, Inc. or its affiliates in the United States and other countries. Third party trademarks mentioned are the property of their respective owners.



NUCLEAR CONTAINMENT SEALS

# Thermowell (TW)

## Temperature sensor protection

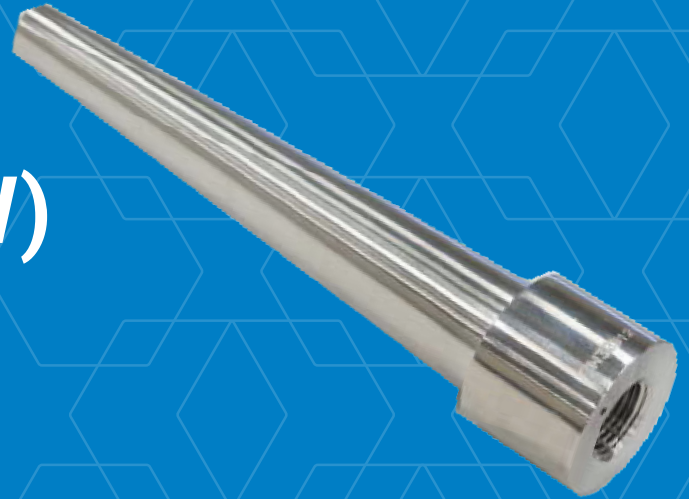

### FEATURES

- TW material as required by the application. For example: Stainless steel, cast iron, and Monel
- Available in standard straight construction or tapered construction for heavy-duty service
- TW mounting can be by National Pipe Tapered (NPT) thread or socket weld interface
- TW interface thread to a temperature sensor can be by NPT thread, straight thread, BSP thread or other
- Protective brass plugs for mounting threads available

### QUALIFICATIONS

- ASME BV Code, Section III, Sub-Sections NB, NC or ND for the specified ASME Code and Addenda
- "N" or "NPT" ASME Certification Mark Available
- ASME PTC 19.3
- PE Certified stress analysis available

### APPLICATIONS

- ✓ Reactor Coolant Loop Fast Response Resistance Temperature Detector (RTD)
- ✓ Room Air Temperature
- ✓ Piping Systems
- ✓ Pump Bearing Temperature Sensor

### DESIGN STYLES

- ✓ Reduced Tipped
- ✓ Stepped
- ✓ Protection Tubes
- ✓ Van Stone
- ✓ Straight
- ✓ Heavy Duty



Heavy-duty and tapered thermowell





SERVICES

# Basic Agreement

## Service Basic Agreement

### DESCRIPTION

Mirion Technologies offers service basic agreement to its customers. This contract includes:

- Hotline support
- E-mail and fax support
- Access to documentation
- Hardware/firmware/software update
- Yearly review meeting

### REFERENCES

Each year Mirion Technologies (MGPI) SAS:

- ✓ Carries out more than 600 on-site service visits which can last from one day to one year, with one or several technicians
- ✓ Receives 30 000 equipment coming back for checking, adjustment or repair
- ✓ Prepares and ships more than 400 spare parts batches
- ✓ Processes over 1 800 calls for technical support
- ✓ Carries out 60 training sessions for more than 400 trainees

## BASIC AGREEMENT

### HOTLINE SUPPORT

A dedicated telephone number is provided. This line will be staffed during normal work hours to answer questions related to normal operation of the equipment or software and first level repair assistance. Outside of normal working hours calls are recorded and dealt with on the next normal work day. 75% of the calls are proceeded during the first day.

### E-MAIL AND FAX SUPPORT

A dedicated e-mail address and fax number are provided. The e-mail and the fax are operated in exactly the same manner as the telephone hotline and are complimentary to it.

### ACCESS TO DOCUMENTATION

Mirion Technologies maintains a comprehensive information library of generic and project specific documentation. This is made available under this contract on a specific request basis. Should you require any document, please send you request marked "document request", to the e-mail support address. We will return the document by e-mail or on a CDRom. Our target is to dispatch this document to you within one week for single documents.

Should you request many documents or archived project documents then we will advise our target delivery date within 1 week of receipt.

### HARDWARE/FIRMWARE/SOFTWARE UPDATE

Mirion Technologies aims to continually improve its products and services. We will inform you of new developments by e-mail only and at least once per year.

When there are new releases in software and firmware for the equipment covered under your contract which add features and fix issues found, we will advise you of the new releases and the reasons for its release. Should you wish a copy of these new releases a request should be made to the dedicated e-mail support address. The costs associated with providing you with these new releases are included in this contract. All information will be provided on a CDRom, by mail. The software is covered by the usual software warranty.

### YEARLY REVIEW MEETING

As part of this contract Mirion Technologies will attend a yearly review meeting on site to discuss the following issues:

- The contract for the following year
- Possible modifications to the service contract
- The application of the escalation formula
- Feedback on the performance provided by Mirion Technologies
- Feedback of the operation and maintenance of the covered equipment

This meeting will occur at the latest one month before the expiry of the contract.

### OPTIONS

- Complete on or off-site training of users on our products
- Maintenance-specific "team-training" on our products
- An annual preventive maintenance contract (standard or extended)
- An annual calibration contract (according to range of equipment), if not choosing a preventive maintenance contract
- An annual set of consumables based on the equipment you have on site
- An annual maintenance visit, if not choosing a preventive maintenance contract



**MIRION**  
TECHNOLOGIES



SERVICES

# Maintenance

## On-site or In-factory Maintenance

### DESCRIPTION

If your objective is to improve production and business, we can carry out for you the maintenance of your systems while ensuring the control of the global cost and your equipment availability.

Mirion Technologies (MGPI) SAS provide you with a long standing manufacturer expertise. Whether it is for on-site or in-factory maintenance, you can benefit from all the necessary services to guarantee the best efficiency of your equipment while ensuring:

- Compliant with your maintenance policy
- Your great satisfaction
- Long-term investments and maintenance cost control

### REFERENCES

Each year Mirion Technologies (MGPI) SAS:

- ✓ Carries out more than 600 on-site service visits which can last from one day to one year, with one or several technicians
- ✓ Receives 30 000 equipment coming back for checking, adjustment or repair
- ✓ Prepares and ships more than 400 spare parts batches
- ✓ Processes over 1 800 calls for technical support
- ✓ Carries out 60 training sessions for more than 400 trainees



## MAINTENANCE

### DESCRIPTION

In line with your schedule, our specialists put your systems into service and perform preventive maintenance, including all the necessary operations for equipment functioning and checking (tests and adjustments, replacement of short-lasting parts, database maintenance...). They also carry out corrective maintenance and take part in system re-qualification. The critical nature of the nuclear instrumentation requires to have urgent on-site interventions or assistance. Mirion Technologies (MGPI) SAS can implement urgent on-site interventions or customized assistance in line with your reliability requirements.

### THIS SERVICE INCLUDES

- The organization of the interventions based on a mutually defined schedule
- Preparation of a works file
- **Works compliance with official procedures including:**
  - Checking of the characteristics of the various subassemblies
  - Replacement of short-lasting parts
  - Tests and various adjustments
  - Data centralization control
- Works completion report
- Travel and related expenses for the whole intervention

### QUALIFICATIONS

- The service provided by Mirion Technologies (MGPI) SAS are carried based on the AFAQ certified ensured quality system ISO 9001
- The organization of Mirion Technologies (MGPI) SAS is QUALIANOR certified in the fields of qualification and the follow-up of personnel exposed to ionizing radiations
- Mirion Technologies (MGPI) SAS is a registered "professional training organisation" referenced under number 91530525013
- Mirion Technologies (MGPI) SAS testing laboratory is COFRAC certified

### OPTIONS

Mirion Technologies (MGPI) SAS has a specific logistic structure to allow reception of contaminated or potentially contaminated equipment in dedicated premises. Mirion Technologies (MGPI) SAS can carry out corrective maintenance of equipment for a yearly fixed-price, whatever kind of breakdown or the number of machines concerned.

Mirion Technologies (MGPI) SAS can ensure the legal maintenance of the equipment to:

- Guarantee on time legal maintenance checking for the all your equipment
- Have permanently operational and tested equipment
- Ensure the necessary number of equipment available
- Constantly know the number of equipment and its allocation

Mirion Technologies (MGPI) SAS provide you with its longlasting expertise in radioprotection instrumentation and maintenance methods to customize the best maintenance policy, based on your requirements.





SERVICES

# Software Maintenance

## Software Maintenance Contract

### DESCRIPTION

You are facing an operational problem: you are using a new function of a Mirion Technologies equipment, the data displayed seems incoherent, an error or a failure message is displayed, your team has changed or a diagnostic is required prior to an intervention...

Mirion Technologies (MGPI) SAS hotline provides direct access to a dedicated radioprotection expert.

Remote maintenance is a technique enabling connection to a remote system for real-time diagnostic, preventive or corrective maintenance purposes. It is a time and costsaving alternative to many on-site interventions.

### REFERENCES

Each year Mirion Technologies (MGPI) SAS:

- ✓ Carries out more than 600 on-site service visits which can last from one day to one year, with one or several technicians
- ✓ Receives 30 000 equipment coming back for checking, adjustment or repair
- ✓ Prepares and ships more than 400 spare parts batches
- ✓ Processes over 1 800 calls for technical support
- ✓ Carries out 60 training sessions for more than 400 trainees

## SOFTWARE MAINTENANCE

### DESCRIPTION

This service gives access to the latest software versions, plus assistance for software troubleshooting.

Software updates include corrections or additional functions, such as upgrades in relation with the associated software packages (operating systems and databases).

For software troubleshooting, a specific process guarantees you the follow-up and traceability of your problem encountered or request.

All new software versions are proposed to our clients along with detailed user's manuals.

### QUALIFICATIONS

- The service provided by Mirion Technologies (MGPI) SAS are carried based on the AFAQ certified ensured quality system ISO 9001
- The organization of Mirion Technologies (MGPI) SAS is QUALIANOR certified in the fields of qualification and the follow-up of personel exposed to ionizing radiations
- Mirion Technologies (MGPI) SAS is a registered "professional training organisation" referenced under number 91530525013
- Mirion Technologies (MGPI) SAS testing laboratory is COFRAC certified

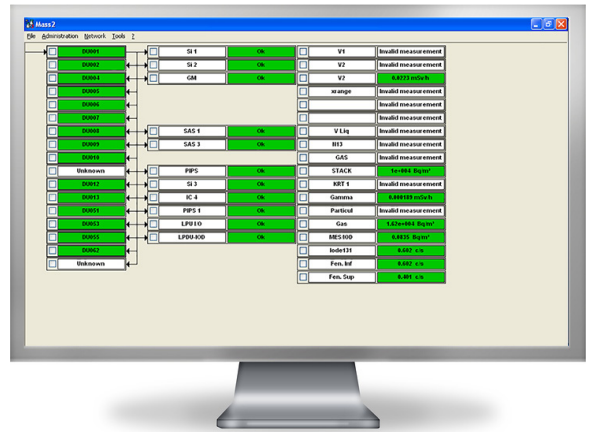



SERVICES

# Hotline & Support

## Technical Support and Remote Maintenance

### DESCRIPTION

You are facing an operational problem: you are using a new function of a Mirion Technologies equipment, the data displayed seems incoherent, an error or a failure message is displayed, your team has changed or a diagnostic is required prior to an intervention...

Mirion Technologies (MGPI) SAS hotline provides direct access to a dedicated radioprotection expert.

Remote maintenance is a technique enabling connection to a remote system for real-time diagnostic, preventive or corrective maintenance purposes. It is a time and cost-saving alternative to many on-site interventions.

### REFERENCES

Each year Mirion Technologies (MGPI) SAS:

- ✓ Carries out more than 600 on-site service visits which can last from one day to one year, with one or several technicians
- ✓ Receives 30 000 equipment coming back for checking, adjustment or repair
- ✓ Prepares and ships more than 400 spare parts batches
- ✓ Processes over 1 800 calls for technical support
- ✓ Carries out 60 training sessions for more than 400 trainees

## HOTLINE & SUPPORT

### TECHNICAL SUPPORT

- In the frame of a customized support contract, Mirion Technologies (MGPI) SAS provides you with a dedicated hotline. Our Technical Support Department can also be reached by e-mail or by fax
- Both direct assistance over the phone and mail, fax or e-mail information are provided for any technical support
- 75% of the calls are proceeded during the first day
- This service includes:
  - Assistance for first-level troubleshooting
  - Technical information on the use of installed equipment or software

### REMOTE MAINTENANCE

- In the frame of a maintenance contract and in addition to the technical support, Mirion Technologies (MGPI) SAS provides remote system maintenance via telephone network
- This service includes:
  - Checking and validation of the system and user configurations and settings
  - Download of software corrections and updates
  - Analysis of historic measurements and events list for system diagnostic and troubleshooting
  - Database integrity and error files content checking
- In order to ensure full confidentiality, connections are systematically made using a specific pre-defined procedure, with prior client acceptance

### QUALIFICATIONS

- The service provided by Mirion Technologies (MGPI) SAS are carried based on the AFAQ certified ensured quality system ISO 9001
- The organization of Mirion Technologies (MGPI) SAS is QUALIANOR certified in the fields of qualification and the follow-up of personel exposed to ionizing radiations
- Mirion Technologies (MGPI) SAS is a registered "professional training organisation" referenced under number 91530525013
- Mirion Technologies (MGPI) SAS testing laboratory is COFRAC certified



**MIRION**  
TECHNOLOGIES



SERVICES

# Taking Back of Sources

## A Global Management of the Requirements to Return Disused Sources

### DESCRIPTION

As a sources holder, you are bounded to manage sources at the end of their useful life. This can be in the event that the source has disused to an extent where it no longer performs the required function, or when the associated equipment is no longer required by you.

We are managing this legal constraint on your behalf by:

- Taking back your sources
- Proceeding to the reprocessing
- Providing you with the mandatory certificates and documents to compliant with the legislation

### REFERENCES

Each year Mirion Technologies (MGPI) SAS:

- ✓ Carries out more than 600 on-site service visits which can last from one day to one year, with one or several technicians
- ✓ Receives 30 000 equipment coming back for checking, adjustment or repair
- ✓ Prepares and ships more than 400 spare parts batches
- ✓ Processes over 1 800 calls for technical support
- ✓ Carries out 60 training sessions for more than 400 trainees

# TAKING BACK OF SOURCES

## DESCRIPTION

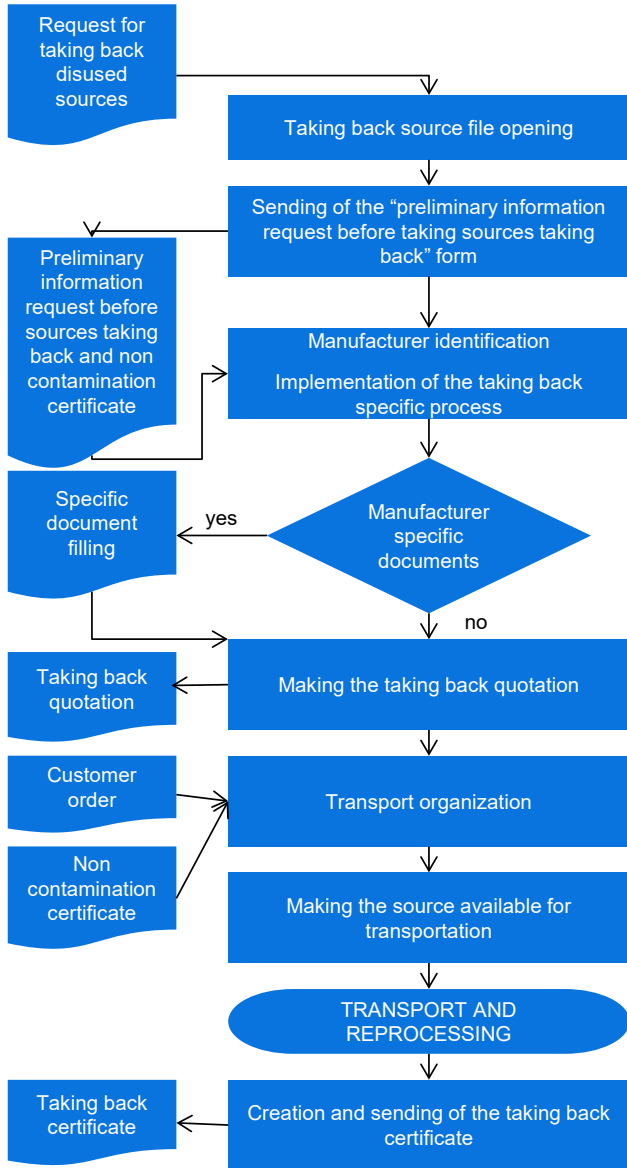

## THIS SERVICE INCLUDES

- The creation and follow-up of your file by a dedicated correspondent
- The research of the original manufacturer
- The management of the taking back by this manufacturer
- The transportation of the source
- The providing of the source taking back certificate

## OPTIONS

- Search of missing documents necessary for taking back source file
- Verification of the contamination level on-site

## QUALIFICATIONS

- The service provided by Mirion Technologies (MGPI) SAS are carried based on the AFAQ certified ensured quality system ISO 9001
- The organization of Mirion Technologies (MGPI) SAS is QUALIANOR certified in the fields of qualification and the follow-up of personnel exposed to ionizing radiations
- Mirion Technologies (MGPI) SAS is a registered "professional training organisation" referenced under number 91530525013
- Mirion Technologies (MGPI) SAS testing laboratory is COFRAC certified





SERVICES

# Training

## In-factory and On-site Trainings

### DESCRIPTION

Mirion Technologies (MGPI) SAS training department has highly competent trainers and dedicated premises equipped with Mirion Technologies products.

Standard or customized training sessions can be offered:

- Initial training
- Operating training
- Level 1 or 2 maintenance training
- Customized training
- Training center training
- On-site training
- Training held in most languages

### REFERENCES

Each year Mirion Technologies (MGPI) SAS:

- ✓ Carries out more than 600 on-site service visits which can last from one day to one year, with one or several technicians
- ✓ Receives 30 000 equipment coming back for checking, adjustment or repair
- ✓ Prepares and ships more than 400 spare parts batches
- ✓ Processes over 1 800 calls for technical support
- ✓ Carries out 60 training sessions for more than 400 trainees



## TRAINING

### DESCRIPTION

- The objective is to give the required knowledge, operating and/or maintenance skills related the Mirion Technologies products
- A training sheet detailing the organization, the contents and duration of the training is submitted for validation
- Our teaching methods are based on alternating theoretical and practical exercises. Training contents can be adapted to the objectives, the technical level of the audience and the required degree of knowledge: initial training, refreshment or complementary training
- We can also adapt our training content to the process in which our products are integrated
- Training courses can be held in our premises or on-site, normally in English or French language.

### THIS SERVICE INCLUDES

- In-factory preparation of the training
- Training course
- Specific training or technical product documentations provided to each participant
- A training report including:
  - Courses attendance sheet
  - The related training sheet
  - Attendance certificates
  - Knowledge control test
  - The training certificate
  - Participants assessment synthesis
  - Trainer assessment
- When the training is made on-site, the travel expenses of the trainers are included
- When the training is made in-factory, the lunches are included
- When the training is made on-site, adequate premises should be provided to Mirion Technologies (MGPI) SAS trainers

### QUALIFICATIONS

- The service provided by Mirion Technologies (MGPI) SAS are carried based on the AFAQ certified ensured quality system ISO 9001
- The organization of Mirion Technologies (MGPI) SAS is QUALIANOR certified in the fields of qualification and the follow-up of personel exposed to ionizing radiations
- Mirion Technologies (MGPI) SAS is a registered "professional training organisation" referenced under number 91530525013
- Mirion Technologies (MGPI) SAS testing laboratory is COFRAC certified





SERVICES

# Warranty Extension

## A Range of Services in Order to Maximize your Investment

### DESCRIPTION

For increased peace of mind and to complement our standard warranties, Mirion Technologies offers solutions that respond to your needs and fit your expectations.

Choosing an extended warranty provides the assurance of having:

- An extension of standard warranty terms
- Software updates for extended periods
- A hotline and e-mail support aff ording faster service repairs
- A free return of defective equipment to the factory
- An increased priority of your repairs in our workflow

### REFERENCES











Each year Mirion Technologies (MGPI) SAS:

- ✓ Carries out more than 600 on-site service visits which can last from one day to one year, with one or several technicians
- ✓ Receives 30 000 equipment coming back for checking, adjustment or repair
- ✓ Prepares and ships more than 400 spare parts batches
- ✓ Processes over 1 800 calls for technical support
- ✓ Carries out 60 training sessions for more than 400 trainees

## WARRANTY EXTENSION

### WARRANTY

Mirion Technologies offers extended warranty terms as compared with those described in our general sales conditions. Two different formulas of extended warranty can be chosen (Silver or Gold):

STANDARD				
SILVER 1 year				
GOLD 2 years				
	Repairing	Hotline	Software Update	Transport

### OPTIONS

Mirion Technologies also offers the following additional customer-service options:

- Complete on or off-site training of users on our products
- Maintenance-specific «team-training» on our products
- An annual preventive maintenance contract (standard or extended)
- An annual calibration contract (according to range of equipment), if not choosing a preventive maintenance contract
- An annual set of consumables based on the equipment you have on site
- An annual maintenance visit, if not choosing a preventive maintenance contract

### SILVER FORMULA

This extended warranty option covers one year from the end of the contractual warranty period. It includes:

- The full services of the standard warranty
- Software update
- The full coverage of all transport costs resulting from products or sub-assemblies that require factory service

### GOLD FORMULA

This formula covers two years from the end of the contractual warranty period. It includes:

- The full coverage of the SILVER warranty
- Prioritization of all service repairs in our workflow





**MIRION**  
TECHNOLOGIES

Copyright © 2025 Mirion Technologies, Inc. or its affiliates. All rights reserved. Mirion, the Mirion logo, and other trade names of Mirion products listed herein are registered trademarks or trademarks of Mirion Technologies, Inc. or its affiliates in the United States and other countries. Third party trademarks mentioned are the property of their respective owners.

MKTG-1313-EN-G - 02/2025

[MIRION.COM](https://www.mirion.com)